

ZVELT ENGINEERING DESIGN

PHAN-NGUYEN RESIDENCE

LATERAL CALCULATIONS

4102 ISLAND CREST WAY, MERCER ISLAND, WA 98040

PREPARED FOR:
Architects NW
18915 142nd Ave NE #100
Woodinville, WA 98072



Description: Two Story Lateral Calculations

Project #: 23-111

Prepared by: Gabriela Siiia

Date: 3/2/2023

ZVELT ENGINEERING DESIGN

PHAN-NGUYEN RESIDENCE

STRUCTURAL CALCULATIONS

4102 ISLAND CREST WAY, MERCER ISLAND, WA 98040

TABLE OF CONTENTS

Section	Number
DESIGN CRITERIA	1
LATERAL CALCULATIONS	2
BASEMENT WALLS	3

ZVELT ENGINEERING DESIGN

PHAN-NGUYEN RESIDENCE

STRUCTURAL CALCULATIONS

4102 ISLAND CREST WAY, MERCER ISLAND, WA 98040

SECTION 1

DESIGN CRITERIA

ZVELT ENGINEERING DESIGN, PLLC

Job Name:	Phan-Nguyen Residence
Project #:	23-111
Plan:	4102 Island Crest Way, Mercer Island, WA 98040
Building Code:	2018 IBC
Permitting Authority:	City of Mercer Island

Gravity Design Loads:

Roof Dead Load	15	psf
Roof Live Load	25	psf
Floor Dead Load	13	psf
Floor Live Load	40	psf

Foundation:

Soil Bearing Press*	1500	psf
Frost Depth*	18	inch

* To be confirmed by the Jurisdiction

Snow:

Ground Snow Load p_g	25	psf
Importance Factor I_s	1	
Snow Exposure C_e	1.00	psf
Thermal Factor C_t	1.00	

Lateral Wind:

Basic Wind Speed V (3-sec gust)	110	mph
Exposure Category	B	
Importance Factor I_w	1	
Topographic Factor K_{zt} *	1.3	

*Per City of Mercer Island Design Criteria

Lateral Seismic:

Site Class (Assumed)	D	
S_s	1.417	g
S_1	0.493	g
F_a	1.200	Interpolated
S_{DS}	1.134	g
Importance Category	II	
Importance Factor I_E	1	
C_s	0.174	
Seismic Design Cat.	D	
Basic LFR System	1 - Bearing Wall System K- Light Frame Walls w/ Shear Panels, Wood with Flexible Diaphragms	
R	6 1/2	
Ω	2.5	
C_d	4	

Concrete:

	f_c	f_y	
Footings/Concrete Walls:	3000	60	ksi
Slab-on-grade:	3000	40	ksi

Lumber :

Item: Species & Grade	F_b	F_v	
2x4 : HF #2	850	150	psi
2x6 & larger 2x 's : HF #2	850	150	psi
4x Beams & Post: DF #2	850	180	psi
6x Beams & Post : DF #2	750	170	psi
Sill Plate Grade: PT HF #2	850	150	psi

Engineered Wood Products:

SWWJ / OWWJ PSL / LSL / LVL Glulam: 2400F-V4	TRUSSES	
Sheathing (roof)	2900	psi
Sheathing (floor)	2400	psi
Sheathing (walls)	15/32	inch
	23/32	inch
	15/32	inch

ZVELT ENGINEERING DESIGN, PLLC

		<i>Project No.</i> 23-111	<i>Sheet No.</i>
<i>Project</i>	Phan-Nguyen Residence		<i>Date</i> 3/2/2023
<i>Subject</i>	Design Weights		<i>By</i> GS

<u>Roof Weights</u>	psf
Roof Sheathing (Composition Shingle) 1/2" Ply	3.2
Roof Framing	4.0
R-49 Insulation	1.5
5/8" Gyp Board	2.8
Misc. Other	2.0
	<hr/> 15.0 psf

Roof Dead Load 15 psf

<u>Exterior Wall Weights</u>	psf
Wall Siding 1/2" Ply	2.5
Framing Member (2x6 Studs @ 16" oc)	1.5
R-21 Batt Insulation	2.3
1/2" Gyp Board	1
Misc. Other	2
	<hr/> 0.7
	<hr/> 10.0 psf

Exterior Wall Dead Load 10 psf

<u>Floor Weights</u>	psf
Flooring Material 3/4" Ply	1.0
Framing Member	2.3
Open Web Trusses at 16" o/c	4
R-30 Batt Insulation	1
5/8" Gyp Board	2.8
Misc. Other	1.9
	<hr/> 13.0 psf

Floor Dead Load 13 psf

⚠ This is a beta release of the new ATC Hazards by Location website. Please [contact us](#) with feedback.

ℹ The ATC Hazards by Location website will not be updated to support ASCE 7-22. [Find out why.](#)

ATC Hazards by Location

Search Information

Address: 4102 Island Crest Way, Mercer Island, WA 98040, USA
Coordinates: 47.5724199, -122.2264912
Elevation: 298 ft
Timestamp: 2023-03-07T21:27:52.143Z
Hazard Type: Seismic
Reference Document: ASCE7-16
Risk Category: II
Site Class: D-default

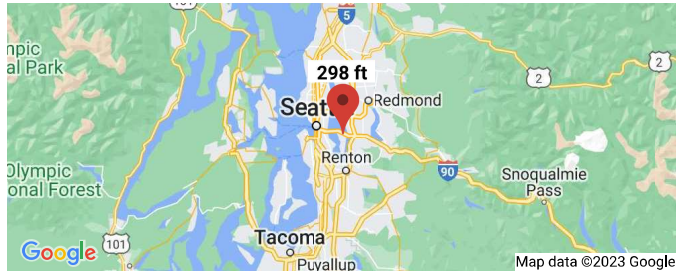

Basic Parameters

Name	Value	Description
S_S	1.417	MCE_R ground motion (period=0.2s)
S_1	0.493	MCE_R ground motion (period=1.0s)
S_{MS}	1.7	Site-modified spectral acceleration value
S_{M1}	* null	Site-modified spectral acceleration value
S_{DS}	1.134	Numeric seismic design value at 0.2s SA
S_{D1}	* null	Numeric seismic design value at 1.0s SA

* See Section 11.4.8

Additional Information

Name	Value	Description
SDC	* null	Seismic design category
F_a	1.2	Site amplification factor at 0.2s
F_v	* null	Site amplification factor at 1.0s
CR_0	0.902	Coefficient of risk (0.2s)
CR_1	0.897	Coefficient of risk (1.0s)
PGA	0.606	MCE_G peak ground acceleration
F_{PGA}	1.2	Site amplification factor at PGA
PGA_M	0.728	Site modified peak ground acceleration
T_L	6	Long-period transition period (s)
$SsRT$	1.417	Probabilistic risk-targeted ground motion (0.2s)
$SsUH$	1.57	Factored uniform-hazard spectral acceleration (2% probability of exceedance in 50 years)
SsD	3.645	Factored deterministic acceleration value (0.2s)
$S1RT$	0.493	Probabilistic risk-targeted ground motion (1.0s)
$S1UH$	0.549	Factored uniform-hazard spectral acceleration (2% probability of exceedance in 50 years)
$S1D$	1.454	Factored deterministic acceleration value (1.0s)
PGA_d	1.241	Factored deterministic acceleration value (PGA)

* See Section 11.4.8

The results indicated here DO NOT reflect any state or local amendments to the values or any delineation lines made during the building code adoption process. Users should confirm any output obtained from this tool with the local Authority Having Jurisdiction before proceeding with design.

Please note that the ATC Hazards by Location website will not be updated to support ASCE 7-22. [Find out why.](#)

Disclaimer

Mercer Island Wind Exposure and Wind Speed-Up (Topographic Effect)

by Development Services Group (DSG), City of Mercer Island
April 2009

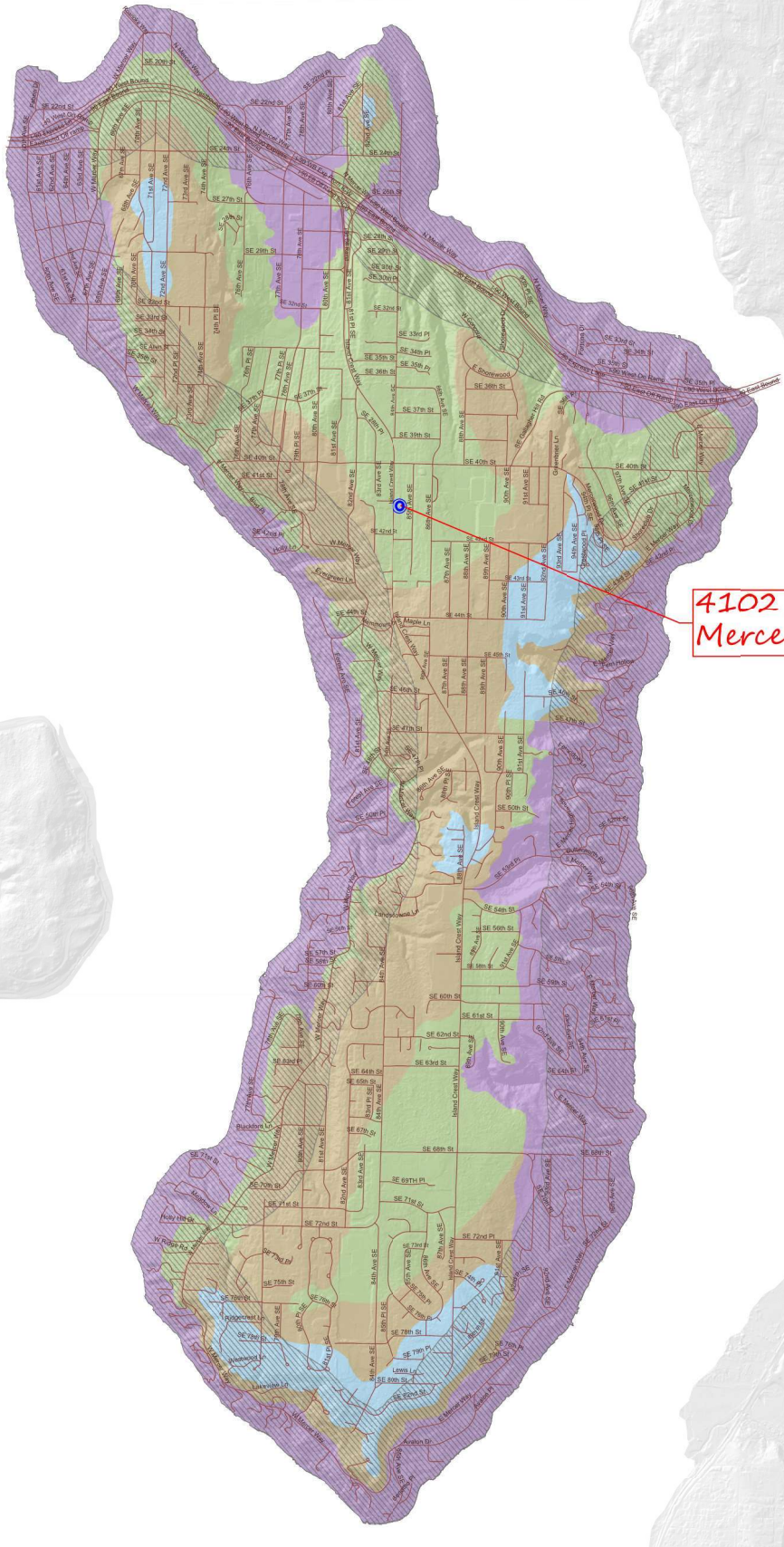
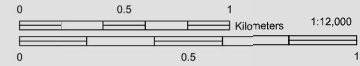

*4102 Island Crest Way
Mercer Island, WA 98040*

WIND EXPOSURE CATEGORIES & WIND SPEED-UP FACTORS (ICC Section 1609 & ASCE 7-05 Chapter 6)

It is the responsibility of the Owner (or their Design Professional) to review site conditions and determine the Kzt factor to be utilized for each specific project. The Kzt factors and wind exposure categories indicated on this map are the minimum values accepted by the City of Mercer Island without requiring the design professional to submit additional calculations and supporting topographic documentation (to verify the values utilized in their wind load determination).

Please note – The Kzt values indicated on this map are approximations based upon periodic calculations of representative samplings around Mercer Island. These values are intended for City of Mercer Island's plan review purposes only.

WIND EXPOSURE CATEGORIES:

Wind Exposure Category		Exposure 'C' (1500 feet from Lake)
		Exposure 'B' (all other areas)

WIND SPEED-UP (TOPOGRAPHIC EFFECT) - K_t Factor :

K _t Factor		K _t = 1.0
		K _t = 1.3
		K _t = 1.6
		K _t = 1.9

GENERAL NOTES FOR WIND EXPOSURE AND WIND SPEED-UP MAP

This map is the Wind Exposure Category and Wind Speed-up (Topographic Effects) Map for the City of Mercer Island. This map shows the minimum wind exposure category and the minimum wind speed-up, K_t factor, which will be accepted without site specific documentation and calculation.

Other wind speed phenomena may occur on Mercer Island that is not specifically identified on this map. It is the responsibility of the Owner (or their Design Professional) to review site conditions and determine the appropriate design wind speed and exposure category for their specific project and location.

This map is for the sole use of the staff of the City of Mercer Island's Development Services Group (DSG) for the purposes of permit application evaluation. This map provides DSG staff a general assessment of Wind Exposure Category and Wind Speed-up (Topographic Effects). All areas have not been specifically evaluated and there may be locations that are not correctly represented on this map. It is the responsibility of individual property owners and map users to evaluate risk associated with their proposed development. No site-specific assessment of risk is implied or otherwise indicated by the City of Mercer Island with this map.

Information about data used for the map, references, and data limitation are all described the associated "Read Me" document. The digital version of this map is accompanied by a meta data file containing pertinent information about map construction. This data map is available on the City of Mercer Island website.

The City of Mercer Island is using guidance provided within ICC Section 1609 & ASCE 7-05 Chapter 6 regarding definitions used when creating this map.

DEFINITIONS:

K_t factor: The topographic effect of wind speed-up at isolated hills, ridges, and escarpments constituting abrupt changes in the general topography, located in any exposure category, that meet all of the conditions noted in ASCE 7-05 Minimum Design Loads for Buildings and Other Structures, Section 6.5.7.

Exposure B: The wind exposure category that applies where the site in question is located a minimum of 1500 feet from the shoreline and the mean roof height is less than or equal to 30 feet per IBC 2006 section 1608.4.3.

Exposure C: The wind exposure category that applies where the site in question is located within 1500 feet from the shoreline per IBC 2006 section 1608.4.3.

Wind Speed: Minimum 85 mph 3-second gust per IRC Figure R301.2(4)

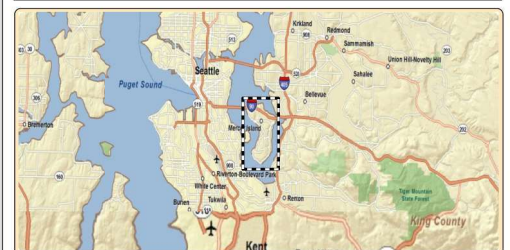

ZVELT ENGINEERING DESIGN

PHAN-NGUYEN RESIDENCE

STRUCTURAL CALCULATIONS

4102 ISLAND CREST WAY, MERCER ISLAND, WA 98040

SECTION 2

LATERAL CALCULATIONS

Wind Pressure

Project Name:	Phan-Nguyen Residence	INPUT
Project Number:	23-111	
Date:	3/2/2023	OUTPUT
By:	GS	
Method:	Envelope Procedure	ASCE 7-16

Governing Equation: $P_s = \lambda k_{zt} p_{s30}$ psf

Wind Region Pressures

Parameter	Value	Code Reference	Page(s)	
Eve Height (ft)	32.50	Measurement	-	
Least Horizontal Dimension (ft)	40	Measurement	-	
Roof Pitch (deg)	14	Measurement	-	
Mean Roof Height (ft)	35.0	Measurement	-	
Basic Wind Speed	110	Figure 26.5-1 B, RISK II	252	
Exposure Category	B	26.7.3	266	
λ : Adjustment for Height and Exposure	1.050	ASCE 7-16, Figure 28.5-1	316	
k_{zt} : Topographic Factor	1.30	ASCE 7-16, 26.8.2	268	
P_{s30} : Simplified Design Wind Pressure	Zone A:	24.1	ASCE 7-16, Figure 28.5-1	318
	Zone B:	-8		
	Zone C:	16		
	Zone D:	-4.6		
P_s : Combined Pressure	Zone A:	32.9	ASCE 7-16, Eq 28.5-1	315
	Zone B:	-10.9		
	Zone C:	21.8		
	Zone D:	-6.3		

P_{s30} : Simplified Design Wind Pressure	Zone E	-23.1	ASCE 7-16, Figure 28.5-1	318
	Zone F	-15.1		
	Zone G	-16		
	Zone H	-11.5		
P_s : Combined Pressure	Zone E	-31.5315	ASCE 7-16, Eq 28.5-1	315
	Zone F	-20.6115		
	Zone G	-21.84		
	Zone H	-15.6975		

P_{s30} : Simplified Design Wind Pressure	Zone EOH:	-32.3	ASCE 7-16, Figure 28.5-1	318
	Zone GOH:	-25.3		
P_s : Combined Pressure	Zone EOH:	-44.0895	ASCE 7-16, Eq 28.5-1	315
	Zone GOH:	-34.5345		

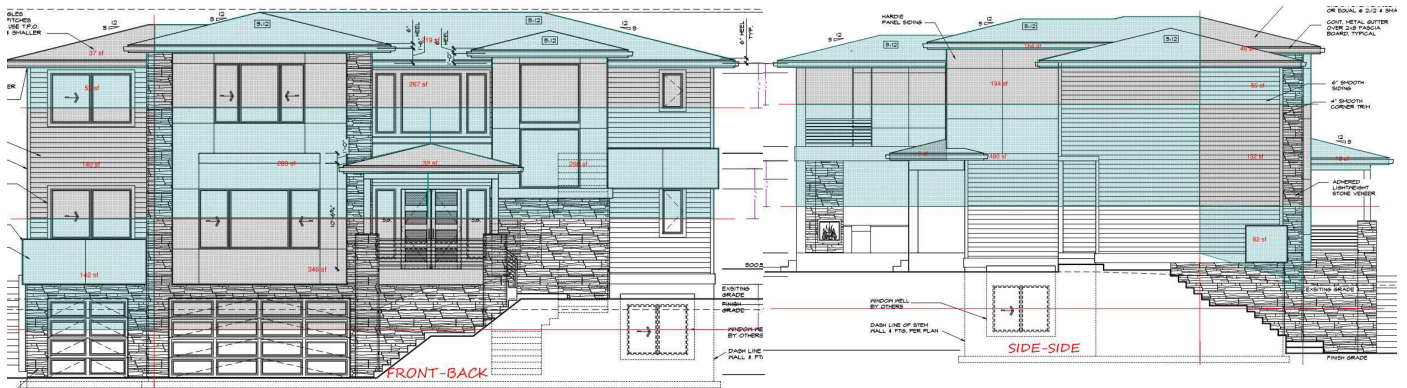

Wind Forces

Project Name: Phan-Nguyen Residence
 Project Number: 23-111
 Date: 3/2/2023
 By: GS
 Method: Envelope Procedure

INPUT
 OUTPUT

Wind Pressures (Side-Side Direction)

Parameter	Value
Least Horizontal Dimension	55.00
Roof Height	36.50
a = Smallest of: 10% Wall Length	5.50
40% Eave Height	4.00
but not less than: 4% Wall Length	2.20
3 feet	3.00
2a	11.00
Roof Level (*Divided by 1.4)	3106.94
Region A Area (sf)	50
Region B Area (sf)	46
Region C Area (sf)	194
Region D Area (sf)	164
Roof Level Wind Force*	4,350 lb
2nd Floor Level (*Divided by 1.4)	10,401
Region A Area (sf)	132
Region B Area (sf)	19
Region C Area (sf)	480
Region D Area (sf)	9
Upper Floor Wind Force*	14,562 lb
1st Floor Level (*Divided by 1.4)	1,927
Region A Area (sf)	82
Region B Area (sf)	0
Region C Area (sf)	0
Region D Area (sf)	0
Upper Floor Wind Force*	2,698 lb

Wind Pressures (Front-Back Direction)

Parameter	Value
Least Horizontal Dimension	68.00
Roof Height	36.50
a = Smallest of: 10% Wall Length	6.80
40% Eave Height	4.00
but not less than: 4% Wall Length	2.72
3 feet	3.00
2a	13.60
Roof Level (*Divided by 1.4)	4116.26
Region A Area (sf)	52
Region B Area (sf)	37
Region C Area (sf)	267
Region D Area (sf)	219
Roof Level Wind Force*	5,763 lb
2nd Floor Level (*Divided by 1.4)	12,210
Region A Area (sf)	140
Region B Area (sf)	0
Region C Area (sf)	581
Region D Area (sf)	32
Upper Floor Wind Force*	17,094 lb
1st Floor Level (*Divided by 1.4)	8,734
Region A Area (sf)	142
Region B Area (sf)	0
Region C Area (sf)	346
Region D Area (sf)	0
Upper Floor Wind Force*	12,228 lb

Diagrams

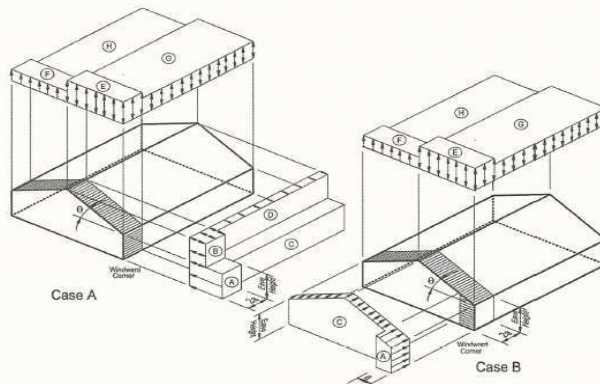

Notation

- a 10% of least horizontal dimension or 0.4h, whichever is smaller, but not less than either 4% of least horizontal dimension or 3 ft (0.9 m).
EXCEPTION: For buildings with $\theta = 0$ to 7° and a least horizontal dimension greater than 300 ft (90 m), dimension a shall be limited to a maximum of 0.8h.
- h Mean roof height, in ft (m), except that eave height shall be used for roof angles $< 10^\circ$.
- θ Angle of plane of roof from horizontal, in degrees.

Notes

1. Pressures shown are applied to the horizontal and vertical projections, for Exposure B, at $h = 30$ ft ($h = 9.1$ m). Adjust to other exposures and heights with adjustment factor λ .
2. The load patterns shown shall be applied to each corner of the building in turn as the reference corner (See Fig. 28.3-1).
3. For Case B, use $\theta = 0^\circ$.
4. Load cases 1 and 2 must be checked for $25^\circ < \theta \leq 45^\circ$. Load case 2 at 25° is provided only for interpolation between 25° and 30° .
5. Plus and minus signs signify pressures acting toward and away from the projected surfaces, respectively.
6. For roof slopes other than those shown, linear interpolation is permitted.
7. The total horizontal load shall not be less than that determined by assuming $p_s = 0$ in Zones B and D.
8. Where Zone E or G falls on a roof overhang on the windward side of the building, use E_{OH} and G_{OH} for the pressure on the horizontal projection of the overhang. Overhangs on the leeward and side edges shall have the basic zone pressure applied.
9. Unit conversions for tables:

Wind Forces

Project Name: Phan-Nguyen Residence
 Project Number: 23-111
 Date: 3/2/2023
 By: GS
 Method: Envelope Procedure

INPUT
 OUTPUT

Unfactored Cumulative Roof Level Wind Force	4,350
Unfactored Cumulative Upper Floor Wind Force	18,911

Roof Level-Uplift F/B	
Region E Area (sf)	374
Region F Area (sf)	374
Region G Area (sf)	1,177
Region H Area (sf)	1,177
Uplift Wind Force	-63683 lb
Roof Level-Uplift S/S	
Region E Area (sf)	474
Region F Area (sf)	474
Region G Area (sf)	1,077
Region H Area (sf)	1,077
Uplift Wind Force	-65144 lb

Roof Level-Dead Load F/B	
Region E Area (sf)	374
Region F Area (sf)	374
Region G Area (sf)	1,177
Region H Area (sf)	1,177
Total Dead Load 2/3	31020 lb
Roof Level-Dead Load S/S	
Region E Area (sf)	474
Region F Area (sf)	474
Region G Area (sf)	1,077
Region H Area (sf)	1,077
Total Dead Load 2/3	31020 lb

Roof Level-Net Uplift F/B L=68 ft	-32663 lb	Fuplift=480 lb
Roof Level-Net Uplift S/S L=52 ft	-34124 lb	Fuplift=656 lb

For top roof uplift provide 48 each truss & each side of multiple trusses.

Seismic Story Force

Project Name:	Phan-Nguyen Residence	Input
Project Number:	23-111	Output
Date:	3/2/2023	
By:	GS	
Method:	ELF Procedure	

Base Shear

Parameter	Value	Source
Risk Category	II	ASCE 7-16, Table 11.6-1
S _{DS}	1.134	ATC Hazard by location
R	6.5	ASCE 7-16 Table 12.2-1
I _e	1	ASCE 7-16 Table 1.5-2
C _s	0.174	-
Roof Area (sf)	3,101	Backgrounds
Roof Dead Load (psf)	15	-
Roof Weight (lb)	46,515	-
3rd FLR Perimeter Length (ft)	232	Backgrounds
3rd FLR Wall Weight (psf)	10	-
3rd FLR Wall Weight (lb)	20,880	-
3rd FLR Weight (PSF)	13	-
3rd FLR Area (sf)	2,193	-
3rd FLR Weight (lb)	33,114	Backgrounds
2nd FLR Perimeter Length (ft)	220	Backgrounds
2nd FLR Wall Weight (psf)	10	-
2nd FLR Wall Weight (lb)	22,000	-
2nd FLR Weight (PSF)	13	-
2nd FLR Area (sf)	2,269	-
2nd FLR Weight (lb)	29,497	Backgrounds
1st FLR Perimeter Length (ft)	87	Backgrounds
1st FLR Wall Weight (psf)	10	-
1st FLR Wall Weight (lb)	7,830	-
Weight	152,006	-
V= C _s *W	26,519	ASCE 7-16 Eq 12.8-1

Base Shear Equation

$$F_x = C_{vx}V \quad \text{ASCE 7-16 12.8-11}$$

Seismic Response Coefficient

$$C_s = S_{DS} / (R/I_e) \quad \text{ASCE 7-16 12.8-2}$$

Story Force Equation

$$C_{vx} = \frac{w_x h_x^k}{\sum_{x=j}^n w_i h_i^k} \quad \text{ASCE 7-16 12.8-12}$$

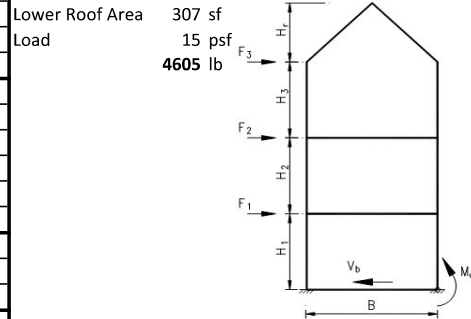

Story Forces

Level	W _x	h _x	W _x h _x	C _{vx}	F _x	Σ
3rd Floor	56,955	31.10	1,771,301	0.526	13,939	13,939
2nd Floor	54,554	22.20	1,211,099	0.359	9,530	23,469
1st Floor	33,412	11.60	387,579	0.115	3,050	26,519
Σ	144,921	-	3,369,979	-	26,519	-

Unfactored Cumulative 3rd Floor Story Force (lb)	13,939
Unfactored Cumulative 2nd Floor Story Force (lb)	23,469
Unfactored Cumulative 1st Floor Story Force (lb)	26,519

111,509

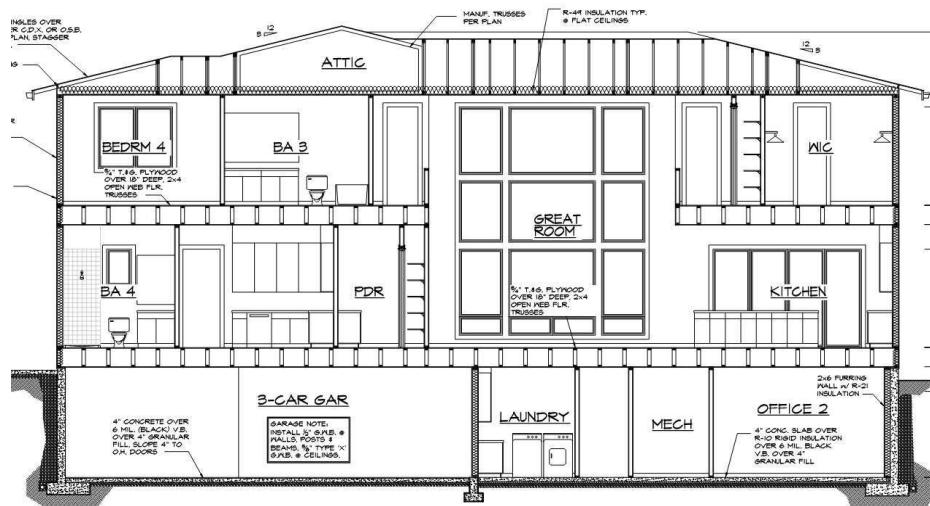

BUILDING SECTION
SCALE: 1/4" = 1'-0"

	Seism (lb)	Wind F13 (lb)	Wind S15 (lb)
3 rd	13939*	4116	3107
2 nd	9530 ^{> 23469}	12210*	10401*
1 st	3050*	8734*	1927
	<u>Σ 26519</u>		* governs

Diaphragm Calcs

$$S_{DS} = 1.134 g$$

ASCE 7 / 12.10.1.1

$$I = 1.00$$

$$W_{3rd} = 56955 \text{ lb} \quad 111509$$

$$W_{2nd} = 54554 \text{ lb} \quad \Sigma W_i = 144921 \text{ lb}$$

$$W_{1st} = 33412 \text{ lb}$$

$$F_{Px} = \frac{\Sigma F_i}{\Sigma W_i} \times W_{Px} \quad \text{Eq 12.10-1}$$

$$F_{Px}^{min} = 0.2 S_{DS} I W_{Px} \quad \text{Eq 12.10-2}$$

$$F_{Px}^{max} = 0.4 S_{DS} I W_{Px} \quad \text{Eq 12.10-3}$$

$$3^{rd} \quad F_p = 13939 \text{ lb} *$$

$$F_p^{min} = 12918 \text{ lb}$$

$$F_p^{max} = 25836 \text{ lb}$$

$$2^{nd} \quad F_p = 11482 \text{ lb}$$

$$F_p^{min} = 12373 \text{ lb} *$$

$$F_p^{max} = 24746 \text{ lb}$$

$$1^{st} \quad F_p = 6114 \text{ lb}$$

$$F_p^{min} = 7578 \text{ lb} *$$

$$F_p^{max} = 15156 \text{ lb}$$

ZVELT ENGINEERING DESIGN, PLLC

<i>Project</i>	Phan-Nguyen Residence	<i>Project No.:</i>	23-111	<i>Sheet No.:</i>	
<i>Subject</i>	Shear Wall/Holdown Design-Third Floor	<i>Date:</i>	3/2/2023	<i>By:</i>	GS

Output	
Input	

W-Wind
S-Seismic

DLR= 15 psf
DLF= 10 psf
DLW= 10 psf

Wall	Length(ft)	H/L Ratio	SW Cap. Coeff.	Total Wall Length(ft)	V (lb)	v (plf)	SW Capacity (plf)	Trib on wall(ft)	Story Height (ft)	OTM (lb-ft)	DL on Wall (lb)	Uplift (lb)	Compression (lb)	SW	Holdown	Post/Studs
GL 1.3	24.00	0.38	1.000	24.00	1436	60	242	3.00	9.00	11761	1409	-	1195	SW-1	<1000 lb	(2)2x
GL 2.3	12.50	0.72	1.000	12.50	3066	245	349	3.00	9.00	25111	734	1726	2376	SW-2	MSTC40	(2)2x
GL 3.3	10.75	0.84	1.000	26.20	3694	141	242	3.00	9.00	12413	631	895	1470	SW-1	<1000 lb	(2)2x
GL 4.3	10.75	0.84	1.000	34.20	3888	114	242	3.00	9.00	10009	631	661	1247	SW-1	<1000 lb	(2)2x
GL 5.3	7.00	1.29	1.000	34.00	1840	54	242	3.00	9.00	3103	411	272	649	SW-1	<1000 lb	(2)2x
GL A.3	4.00	2.25	0.889	21.50	6970	365	456	3.00	9.00	11948	235	3296	3104	SW-3	MSTC66B3	(2)2x
GL C.3	3.08	2.92	0.684	22.20	6970	459	595	3.00	9.00	11571	181	4395	3847	SW-4	MSTC66/MSTC66B3	(2)2x

2b/h

ASCE 7-16 Governing Load Case: 0.6D-0.7Ev+0.7Eh where $\rho = 1.3$
 0.441D+0.91E where Sds=1.134 g
 0.6D+0.6W
 Eh= ρE
 Ev= 0.2S_{bs}D

Notes:
 GL C.3 Ext HDR left & right over SW at BDR3, H=8 ft

GL C.3	2.33	3.43	0.583	22.20	6970	539	595	3.00	8.00	9143	127	4933	3987	SW-4	MSTC66/MSTC66B3	(2)2x
--------	------	------	-------	-------	------	-----	-----	------	------	------	-----	------	------	------	-----------------	-------

ZVELT ENGINEERING DESIGN, PLLC		Project No: 23-111	Sheet No:
Project	Phan-Nguyen Residence		
Date:	3/2/2023		
Subject	Shear Wall/Holdown Design - Second Floor		
By:	GS		

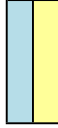

Output
Input

W-Wind
S-Seismic

DLr= 15 psf
DLf= 10 psf
DLw= 10 psf

Wall	Length(ft)	H/L Ratio	SW Cap. Coeff.	Total Wall Length(ft)	V (lb)	v above(plf)	v (plf)	SW Capacity (plf)	Story Height (ft)	OTM (lb-ft)	DL on Wall (lb)	Uplift (lb)	Compression (lb)	SW	Holdown	Post/Studs
GL 1.2	20.00	0.50	1.000	20.00	1258	1436	135	339	10	16164	3478	-	3742	SW-1	<1000 lb	(2) 2x
GL 2.2	14.50	0.69	1.000	14.50	2796	3066	404	489	10	35172	2130	1447	5866	SW-2	HDU5	(2) 2x
GL 3.2	10.00	1.00	1.000	21.80	3223	3694	317	339	10	19038	1639	1185	4194	SW-1	MSTC66B3	(2) 2x
GL 4.2	6.50	1.54	1.000	21.60	3538	3888	344	489	10	13408	1366	1552	3992	SW-2	MSTC66B3/HDU5	(2) 2x
GL 5.2	4.50	2.22	0.900	16.80	1612	1840	228	339	10	6164	910	1086	2474	SW-1	HDU5/MSTC66B3	(2) 2x
GL A.2	3.00	3.3	0.600	14.00	2475	6970	1124	1274	10	20239	554	7819	10128	SW-6	HDU8	(3) 2xDF2
GL B.2	4.00	2.5	0.800	24.20	5200	0	269	339	10	6446	312	1686	1768	SW-1	HDU5	(2) 2x
GL C.2	3.08	3.2	0.616	19.00	2725	6970	828	990	10	15308	486	5690	9061	SW-5	HDU8/MSTC78	(3) 2xDF2

2b/h

ASCE 7-16 Governing Load Case:
 0.6D-0.7Ev+0.7Eh
 0.441D+0.91E
 0.6D+0.6W
 Eh= pE
 Ev= 0.2S_{psD}

Seism where p = 1.3
 Wind where S_{ds}=1.134 g

Notes:
 GL C.2 Ext HDR left & right over SW at LIVING, H=9 ft

GL C.2	2.70	3.3	0.600	19.00	2725	6970	850	990	9	12399	440	5416	8660	SW-5	MSTC66/(2)MSTC66B3	(2)/(2) 2x
--------	------	-----	-------	-------	------	------	-----	-----	---	-------	-----	------	------	------	--------------------	------------

ZVELT ENGINEERING DESIGN, PLLC

Project No: 23-111		Sheet No:
Project	Phan-Nguyen Residence	
Subject	Shear Wall/Holdown Design - First Floor	
	Date: 3/2/2023	
	By: GS	

DLr= 15 psf
 DLf= 10 psf
 DLw= 10 psf

Output
 Input

W-Wind
 S-Seismic
 Seismic controls

Wall	Length(ft)	H/L Ratio	SW Cap. Coeff.	Total Wall Length(ft)	V (lb)	v above(plf)	v (plf)	SW Capacity (plf)	Story Height (ft)	OTM (lb-ft)	DL on Wall (lb)	Uplift (lb)	Compression (lb)	SW	Holdown	Post/Studs
GL 1.1														conc. wall		
GL 2.1														conc. wall		
GL 3.1	7.42	1.35	1.000	29.70	2760	6917	326	339	10.00	14506	1945	1124	2927	SW-1	HDU5	(2) 2x W
GL 4.1	7.70	1.30	1.000	7.70	2210	7426	1251	1274	10.00	57816	1511	7275	8264	SW-6	HDU8	(3) 2x DF2 W
GL 5.1														conc. wall		
GL A.1														conc. wall		
GL B.1														conc. wall		

ASCE 7-16 Governing Load Case:

$0.6D-0.7E_v+0.7E_h$
 $0.441D+0.91E$
 $0.6D+0.6W$
 $E_h = \rho E$
 $E_v = 0.2S_{bs}D$

Seism where $\rho = 1.3$
 Wind where $S_{ds} = 1.134 g$

2b/h

Roof Diaphragm Design-Seismic Forces

Client: Architects NW
 Project Name: Phan-Nguyen Residence
 Project Number: 23-111
 Date: 3/2/2023
 By: GS

Design Criteria IBC 2018

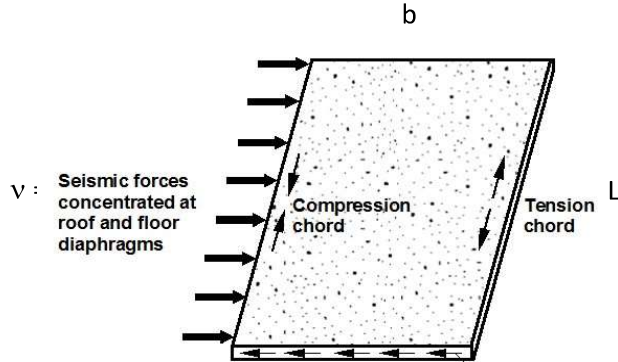

Front/Back

V=	13939	lb	REACTIONS	
L=	49	ft	Ra=Rb= $\frac{wl}{2}$	Ra=Rb= 6969.5
b=	68	ft	MOMENT	
v =	284	plf	M = $\frac{wl^2}{8}$	M= 85376
unit shear	102	plf	CHORD	
15/32" CD-EXT DIA SHEATHING APA-RATED			T=C= $\frac{M}{b}$	T=C= 1256
0.131"Ø x 2 1/2" NAILING			Propose: 2x6 HF#2	
8d @ 6"OC EDGE			A=	8.25
8d @ 12"OC FIELD			ft=	325
8d @ 6"OC BOUNDARY where shaded on the plan			fb=	675
237 PLF UNIT SHEAR CAPACITY			Tcapable=	2681
251 PLF UNIT SHEAR CAPACITY BLOCKED			Tactual=	1256

Left/Right

V=	13939	lb	REACTIONS	
L=	68	ft	Ra=Rb= $\frac{wl}{2}$	Ra=Rb= 6969.5
b=	49	ft	MOMENT	
v =	205	plf	M = $\frac{wl^2}{8}$	M= 118482
unit shear	142	plf	CHORD	
15/32" CD-EXT DIA SHEATHING APA-RATED			T=C= $\frac{M}{b}$	T=C= 2418
0.131"Ø x 2 1/2" NAILING			Propose: 2x6 HF#2	
8d @ 6"OC EDGE			A=	8.25
8d @ 12"OC FIELD			ft=	325
8d @ 6"OC BOUNDARY where shaded on the plan			fb=	675
237 PLF UNIT SHEAR CAPACITY			Tcapable=	2681
251 PLF UNIT SHEAR CAPACITY BLOCKED			Tactual=	2418

Second Floor Diaphragm Design-Seismic Forces

Client: Architects NW
 Project Name: Phan-Nguyen Residence
 Project Number: 23-111
 Date: 3/2/2023
 By: GS

Design Criteria IBC 2018

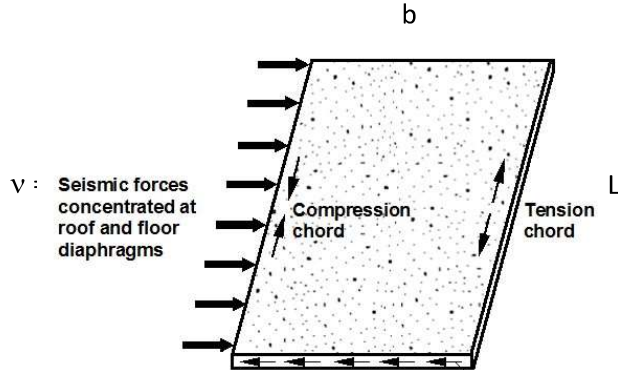

Front/Back

V=	12373	lb	<u>REACTIONS</u>		
L=	68	ft	Ra=Rb=	$\frac{wl}{2}$	Ra=Rb= 6186.5
b=	43	ft	<u>MOMENT</u>		
v =	182	plf	M =	$\frac{wl^2}{8}$	M= 105171
unit shear	143.872093	plf	<u>CHORD</u>		
23/32" CD-EXT	DIA SHEATHING APA-RATED		T=C=	$\frac{M}{b}$	T=C= 2446
0.148"Ø x 3"	NAILING		<u>Propose:</u>	2x6 HF#2	A= 8.25
10d @ 6"OC	EDGE				ft= 325
10d @ 12"OC	FIELD				fb= 675
10d @ 6"OC	BOUNDARY where shaded on the plan		<u>Tcapable=</u>	2681	Tactual= 2446
<u>265</u>	PLF UNIT SHEAR CAPACITY				
298	PLF UNIT SHEAR CAPACITY BLOCKED				

Left/Right

V=	12373	lb	<u>REACTIONS</u>		
L=	43	ft	Ra=Rb=	$\frac{wl}{2}$	Ra=Rb= 6186.5
b=	68	ft	<u>MOMENT</u>		
v =	288	plf	M =	$\frac{wl^2}{8}$	M= 66505
unit shear	90.97794118	plf	<u>CHORD</u>		
23/32" CD-EXT	DIA SHEATHING APA-RATED		T=C=	$\frac{M}{b}$	T=C= 978
0.148"Ø x 3"	NAILING		<u>Propose:</u>	2x6 HF#2	A= 8.25
10d @ 6"OC	EDGE				ft= 325
10d @ 12"OC	FIELD				fb= 675
10d @ 6"OC	BOUNDARY where shaded on the plan		<u>Tcapable=</u>	2681	Tactual= 978
<u>265</u>	PLF UNIT SHEAR CAPACITY				
298	PLF UNIT SHEAR CAPACITY BLOCKED				

First Floor Diaphragm Design-Seismic Forces

Client: Architects NW
 Project Name: Phan-Nguyen Residence
 Project Number: 23-111
 Date: 3/10/2023
 By: GS

Design Criteria IBC 2018

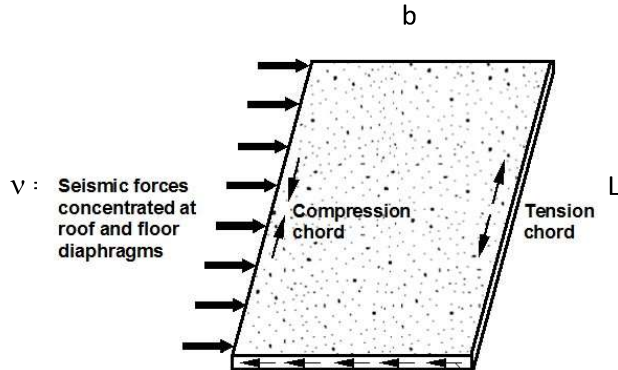

Front/Back

V= 7578 lb
 L= 43 ft
 b= 68 ft
 v = 176 plf
 unit shear 55.72058824 plf

23/32" CD-EXT	DIA SHEATHING APA-RATED
0.148"Ø x 3"	NAILING
10d @ 6"OC	EDGE
10d @ 12"OC	FIELD
10d @ 6"OC	BOUNDARY where shaded on the plan
265	PLF UNIT SHEAR CAPACITY

298 PLF UNIT SHEAR CAPACITY BLOCKED

REACTIONS
 $R_a=R_b = \frac{wL}{2}$ Ra=Rb= 3789

MOMENT
 $M = \frac{wL^2}{8}$ M= 40732

CHORD
 $T=C = \frac{M}{b}$ T=C= 599

Propose: 2x6 HF#2 A= 8.25
 ft= 325
 fb= 675

Tcapable= 2681 Tactual= 599

Left/Right

V= 6910 lb
 L= 68 ft
 b= 43 ft
 v = 102 plf
 unit shear 80.34883721 plf

23/32" CD-EXT	DIA SHEATHING APA-RATED
0.148"Ø x 3"	NAILING
10d @ 6"OC	EDGE
10d @ 12"OC	FIELD
10d @ 6"OC	BOUNDARY where shaded on the plan
265	PLF UNIT SHEAR CAPACITY

298 PLF UNIT SHEAR CAPACITY BLOCKED

REACTIONS
 $R_a=R_b = \frac{wL}{2}$ Ra=Rb= 3455

MOMENT
 $M = \frac{wL^2}{8}$ M= 58735

CHORD
 $T=C = \frac{M}{b}$ T=C= 1366

Propose: 2x6 HF#2 A= 8.25
 ft= 325
 fb= 675

Tcapable= 2681 Tactual= 1366

FLOOR PLAN NOTES:
 1. CONVEYORS PRIOR TO FABRICATION & CONSTRUCTION. VERIFY ALL DIMENSIONS AND ELEVATIONS WITH THE HOLD-DOWN SCHEDULE PLAN S1 FOR HOLD-DOWN PLAN FOR OTHER STUDY/POST REQUIREMENTS.
 2. HDL INDICATES A HOLD-DOWN. REFERENCE THE HOLD-DOWN SCHEDULE PLAN S1 FOR HOLD-DOWN PLAN FOR OTHER STUDY/POST REQUIREMENTS.
 3. HDL INDICATES A HOLD-DOWN. REFERENCE THE HOLD-DOWN SCHEDULE PLAN S1 FOR HOLD-DOWN PLAN FOR OTHER STUDY/POST REQUIREMENTS.
 4. SWL INDICATES A SHEAR WALL. REFERENCE THE SHEAR WALL SCHEDULE PLAN S2 FOR SHEAR WALL SCHEDULES.
 5. SWL INDICATES A SHEAR WALL. REFERENCE THE SHEAR WALL SCHEDULE PLAN S2 FOR SHEAR WALL SCHEDULES.
 6. CONTINUOUS BETWEEN ROOF SHEATHING AND TOP OF FOUNDATION WALL. SHEAR WALLS SHALL BE CONTINUOUS BETWEEN ROOF SHEATHING AND TOP OF FOUNDATION WALL. SHEAR WALLS SHALL BE CONTINUOUS THROUGH ALL WALL TYPES.
 7. SHEAR WALL TO BE CONTINUOUS THRU WALL TYPES.
 8. WALL EXTERIOR WALLS TO BE SWL1 UNLESS NOTED ON THE PLAN.

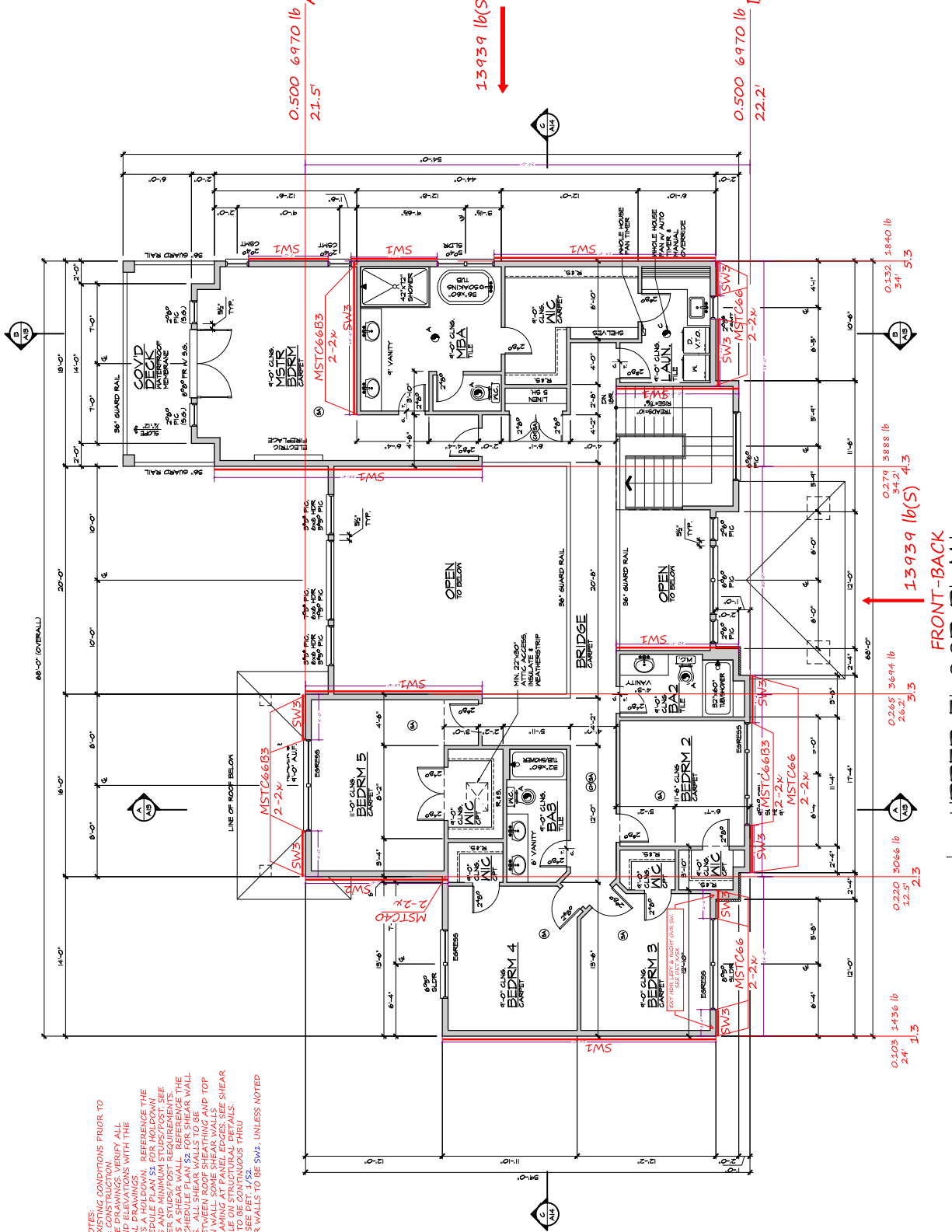

FRONT-BACK
 UPPER FLOOR PLAN

SCALE: 1/4" = 1'-0"

DATE: 12/22/22
 LITERAL JOB NUMBER: A9
 SHEET NUMBER: A14

PHAN-NGUYEN RESIDENCE
 4102 ISLAND CREST WAY, MERCER ISLAND, WA 98040
 PLAN M5762A3FU-0FB
 ARCHITECTS NORTHWEST
 18905-1624 AVENUE NE SUITE 100
 WOODVILLE, WA 98072
 FAX: (425) 487-6585
 WWW.ARCHITECTSNW.COM

PHAN-NGUYEN RESIDENCE
 4102 ISLAND CREST WAY, MERCER ISLAND, WA 98040
 PLAN M5762A3FU-0FB
 ARCHITECTS NORTHWEST
 18905-1624 AVENUE NE SUITE 100
 WOODVILLE, WA 98072
 FAX: (425) 487-6585
 WWW.ARCHITECTSNW.COM

FLOOR PLAN NOTES:
 1. ALL CONDITIONS PRIOR TO FABRICATION & CONSTRUCTION. VERIFY ALL DIMENSIONS AND ELEVATIONS WITH THE ARCHITECT. 2. DO NOT SCALE DRAWINGS. 3. HD, INDICATES A HOLD-DOWN. REFER TO THE HOLD-DOWN SCHEDULE PLAN S1 FOR HOLD-DOWN PLAN FOR OTHER STUDY/POST REQUIREMENTS. 4. SW, INDICATES A SHEAR WALL. REFER TO THE SHEAR WALL SCHEDULE PLAN S2 FOR WALL REQUIREMENTS. 5. S, INDICATES A CONTINUOUS BETWEEN ROOF SHEATHING AND TOP OF FOUNDATION WALL. SOME SHEAR WALLS WILL BE CONTINUOUS THRU WALLS SCHEDULE ON STRUCTURAL DETAILS. 6. WALL EXTERIOR WALLS TO BE S.W.I. UNLESS NOTED ON THE PLAN.

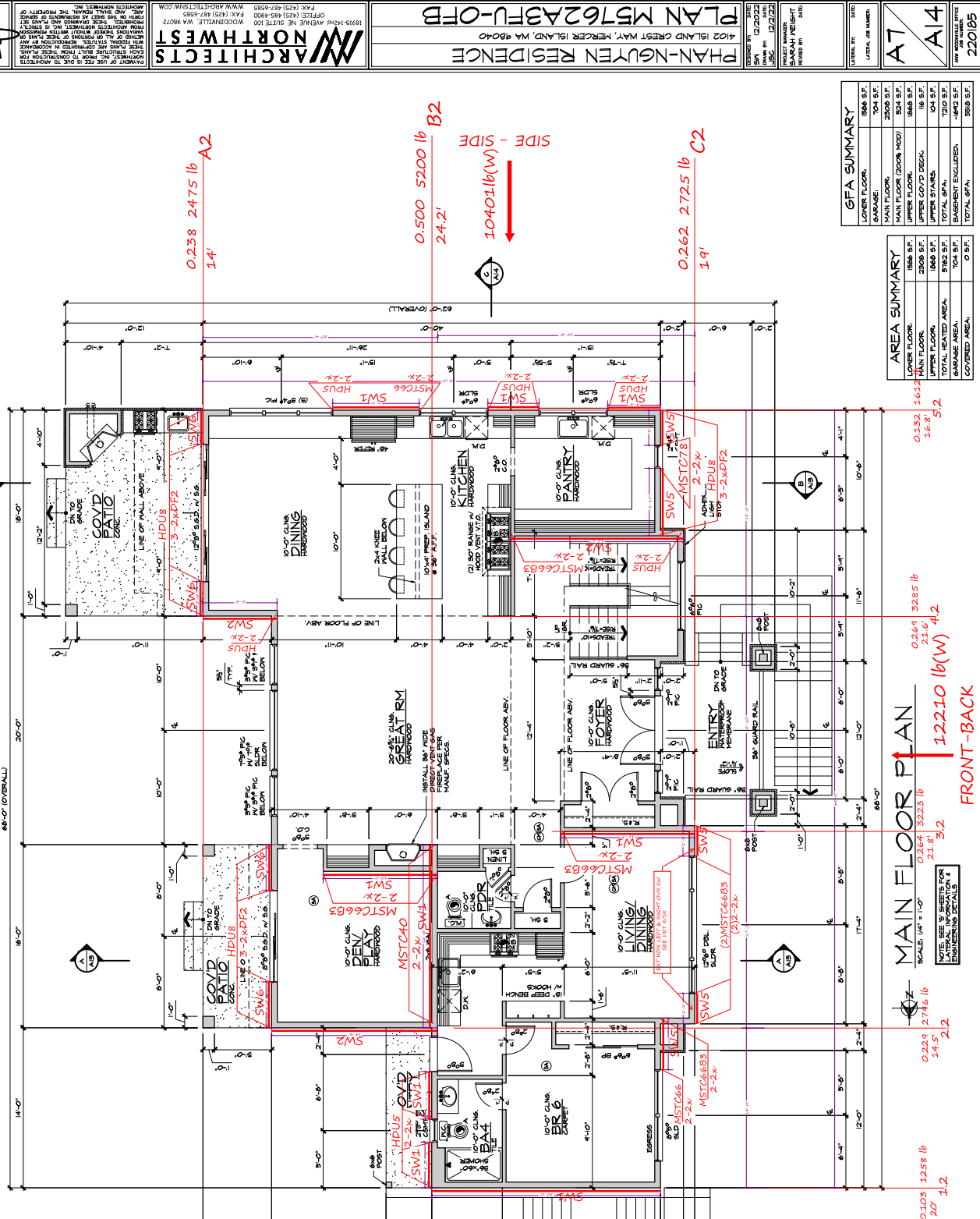

AREA SUMMARY	
LOWER FLOOR	1848 S.F.
MAIN FLOOR	2808 S.F.
UPPER FLOOR	1848 S.F.
TOTAL HEATED AREA	6504 S.F.
GARAGE AREA	104 S.F.
COVERED AREA	0 S.F.

GFA SUMMARY	
LOWER FLOOR	1848 S.F.
MAIN FLOOR	2808 S.F.
UPPER FLOOR	1848 S.F.
TOTAL GFA	6504 S.F.
GARAGE AREA	104 S.F.
COVERED AREA	0 S.F.

MAIN FLOOR PLAN
 SCALE: 1/4" = 1'-0"
 DATE: 12/27/22
 PROJECT NUMBER: 220185
 SHEET NUMBER: A7
 SHEET TITLE: MAIN FLOOR PLAN
 INTERIOR FINISHES & MATERIALS SCHEDULES & ENGINEERING DETAILS

FLOOR PLAN NOTES:
 1. VERIFY ALL EXISTING CONDITIONS PRIOR TO DIMENSIONS AND ELEVATIONS WITH THE 200 NOT SCALE DRAWINGS. VERIFY ALL DIMENSIONS AND ELEVATIONS WITH THE 200 NOT SCALE DRAWINGS.
 2. DIMENSIONS AND ELEVATIONS WITH THE 200 NOT SCALE DRAWINGS.
 3. HD - INDICATES HOLD-DOWN. REFERENCE THE HOLD-DOWN SCHEDULE PLAN S1 FOR HOLD-DOWN REQUIREMENTS AND MINIMUM STUDS/FOOT. SEE SHEAR WALL SCHEDULE PLAN S2 FOR SHEAR WALL REQUIREMENTS AND MINIMUM STUDS/FOOT. SEE SHEAR WALL SCHEDULE PLAN S3 FOR SHEAR WALL REQUIREMENTS AND MINIMUM STUDS/FOOT. SEE SHEAR WALL SCHEDULE PLAN S4 FOR SHEAR WALL REQUIREMENTS AND MINIMUM STUDS/FOOT. SEE SHEAR WALL SCHEDULE PLAN S5 FOR SHEAR WALL REQUIREMENTS AND MINIMUM STUDS/FOOT.
 4. SW - INDICATES A SHEAR WALL. REFERENCE THE SHEAR WALL SCHEDULE PLAN S2 FOR SHEAR WALL REQUIREMENTS AND MINIMUM STUDS/FOOT. SEE SHEAR WALL SCHEDULE PLAN S3 FOR SHEAR WALL REQUIREMENTS AND MINIMUM STUDS/FOOT. SEE SHEAR WALL SCHEDULE PLAN S4 FOR SHEAR WALL REQUIREMENTS AND MINIMUM STUDS/FOOT. SEE SHEAR WALL SCHEDULE PLAN S5 FOR SHEAR WALL REQUIREMENTS AND MINIMUM STUDS/FOOT.
 5. SHEAR WALL TO BE CONTINUOUS THRU INTERSECTION. SEE DET. 1.7.2.
 6. SHEAR WALLS TO BE SW1, UNLESS NOTED ON THE PLAN.

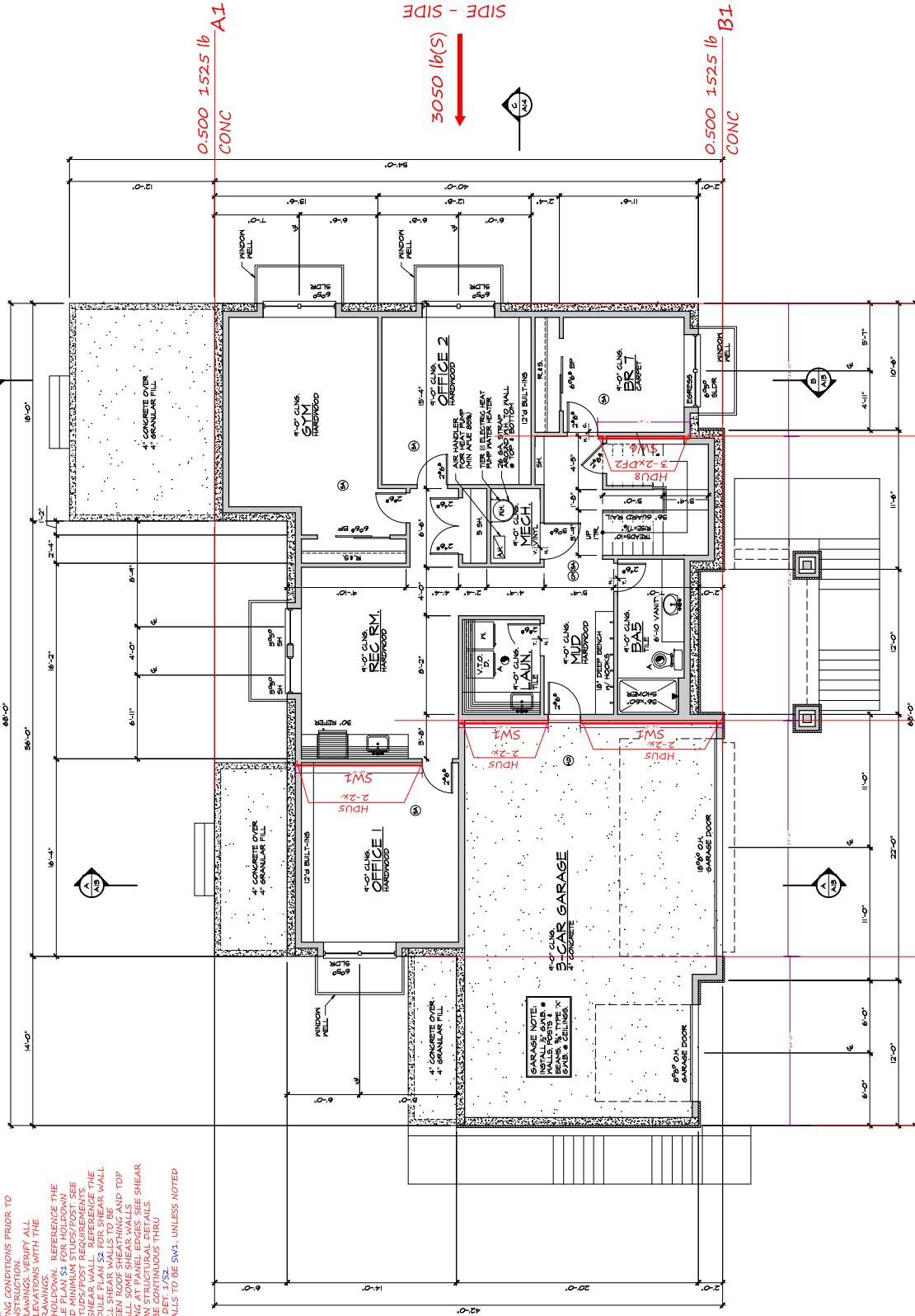

FLOOR PLAN NOTES:
 1. CONTRACTOR SHALL VERIFY ALL NOTES, DIMENSIONS & CONDITIONS.
 2. DIMENSIONS & DOORS ARE SHOWN & NOTED AS MINIMAL SIZES.
 3. DIMENSIONS & DOORS ARE SHOWN & NOTED AS MINIMAL SIZES.
 4. SOFFIT DOWN AREAS ARE SHOWN.
 5. INDICATES POINT LOAD SUPPORTED BY (2) STUDS UNLESS NOTED OTHERWISE.
 6. FOLLOWINGS ARE NOT CONSIDERED HABITABLE ROOMS: BATHROOMS, TOILETS, CLOSETS, HALLS, STORAGE OR UTILITY SPACES AND SOLAR ROOMS.
 7. SEE SHEET A1 FOR ADDITIONAL NOTES.
 8. SEE SHEET A1 FOR VENTILATION AND PLUMB SCHEDULES.

LOWER FLOOR PLAN
 SCALE: 1/4" = 1'-0"
 DATE: 12/22/22
 DRAWN BY: SARAH WRIGHT
 CHECKED BY: SARAH WRIGHT
 PROJECT NUMBER: 220185

0.103 400 lb
 CONC 1.1

0.246 2318 lb
 CONC 2.1

0.316 2760 lb
 297.7
 3.1

0.53 2210 lb
 7.7 4.1

0.080 699 lb
 CONC 5.1

0.500 1525 lb
 CONC A1

0.500 1525 lb
 CONC B1

3050 lb(S)
 SIDE - SIDE

8734 lb(W)
 FRONT-BACK

ZVELT ENGINEERING DESIGN

PHAN-NGUYEN RESIDENCE

STRUCTURAL CALCULATIONS

4102 ISLAND CREST WAY, MERCER ISLAND, WA 98040

SECTION 3

BASEMENT WALLS

① Full Height - top restrained (BR7)

Vertical loads

Roof DL 4' (trib) \times 15 pcf

LL 4' \times 25 pcf

Upper DL 6.5' \times 13 pcf

LL 6.5' \times 40 pcf

Main DL 6.5' \times 13 pcf

LL 6.5' \times 40 pcf

Total

DL = 419 pcf

LL = 620 pcf

Wall 19' (H) \times 10 pcf
DL

Lateral loads

$Q_E = 10 H$ (H - buried depth) assumed

② Retaining Wall - top unrestrained

Vertical loads

(stair case)

Roof DL 4.5' (trib) \times 15 pcf

LL 4.5' \times 25 pcf

Stair DL (3' + 3') \times 10 pcf

LL (3' + 3') \times 100 pcf

Wall DL 21' \times 10 pcf

Total

DL = 338 pcf

LL = 713 pcf

Lateral loads

$Q_E = 8 H$ (H - buried depth) assumed

Use menu item **Settings > Printing & Title Block**
to set these five lines of information
for your program.

Project Name/Number : 23-111

Title 11 FT top restrained
Dsgnr: gs
Description....
23-111

Page : 1
Date: 9 MAR 2023

This Wall in File: C:\ZVELT-ONE DRIVE\ZVELT JOBS\2023\23-111 Mercer Island Phan-Nguyen Res M5762A3FU

RetainPro (c) 1987-2019, Build 11.19.11.12
License : KW-06061901
License To : Zvelt Engineering Design, PLLC

Restrained Retaining Wall

Code: IBC 2018,ACI 318-14,TMS 402-16

Criteria

Retained Height = 10.50 ft
Wall height above soil = 0.50 ft
Total Wall Height = 11.00 ft

Top Support Height = 11.00 ft

Slope Behind Wal = 0.00
Height of Soil over Toe = 0.00 in

Soil Data

Allow Soil Bearing = 1,500.0 psf
Equivalent Fluid Pressure Method
At-Rest Heel Pressure = 50.0 psf/ft
=
Passive Pressure = 300.0 psf/ft
Soil Density = 130.00 pcf
Footing||Soil Frictior = 0.350
Soil height to ignore
for passive pressure = 0.00 in

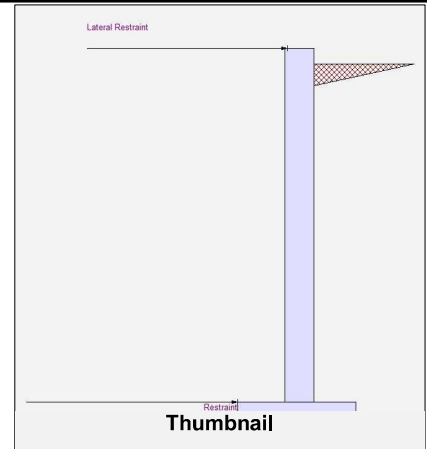

Surcharge Loads

Surcharge Over Heel = 70.0 psf
>>>NOT Used To Resist Sliding & Overturn
Surcharge Over Toe = 0.0 psf
NOT Used for Sliding & Overturning

Axial Load Applied to Stem

Axial Dead Load = 419.0 lbs
Axial Live Load = 620.0 lbs
Axial Load Eccentricity = 0.0 in

Earth Pressure Seismic Load

Uniform Lateral Load Applied to Stem

Lateral Load = 105.0 #/ft
...Height to Top = 10.50 ft
...Height to Bottorr = 0.00 ft

Load Type = Seismic (E)
(Strength Level)

Wind on Exposed Stem = 0.0 psf

K_h Soil Density Multiplier = 0.050 g Added seismic per unit area = 0.0 psf

Adjacent Footing Load

Adjacent Footing Load = 0.0 lbs
Footing Width = 0.00 ft
Eccentricity = 0.00 in
Wall to Ftg CL Dist = 0.00 ft
Footing Type = Line Load
Base Above/Below Soil
at Back of Wall = 0.0 ft
Poisson's Ratio = 0.300

Design Summary

Total Bearing Load = 4,890 lbs
...resultant ecc. = 0.00 in

Soil Pressure @ Toe = 1,304 psf OK
Soil Pressure @ Heel = 1,304 psf OK
Allowable = 1,500 psf
Soil Pressure Less Than Allowable
ACI Factored @ Toe = 1,875 psf
ACI Factored @ Heel = 1,875 psf
Footing Shear @ Toe = 14.3 psi OK
Footing Shear @ Heel = 4.3 psi OK
Allowable = 82.2 psi
Reaction at Top = 987.4 lbs
Reaction at Bottom = 3,729.9 lbs

Sliding Calcs

Lateral Sliding Force = 3,729.9 lbs

Concrete Stem Construction

Thickness = 10.00 in F_y = 60,000 psi
Wall Weight = 125.0 psf f_c = 3,000 psi
Stem is FIXED to top of footing

	@ Top Support	Mmax Between Top & Base	@ Base of Wall
Design Height Above Ftg	Stem OK = 11.00 ft	Stem OK = 6.27 ft	Stem OK = 0.00 ft
Rebar Size	# 5	# 5	# 5
Rebar Spacing	12.00 in	12.00 in	12.00 in
Rebar Placed at	Edge	Edge	Edge
Rebar Depth 'd'	7.50 in	8.00 in	7.50 in

Design Data

fb/FB + fa/Fa = 0.000 0.397 0.914
Mu....Actual = 0.0 ft-# 4,261.1 ft-# 9,171.5 ft-#
Mn * Phi....Allowable = 10,037.3 ft-# 10,734.8 ft-# 10,037.3 ft-#
Shear Force @ this height = 1,412.7 lbs 4,856.0 lbs

Shear.....Actual = 15.70 psi 53.96 psi
Shear.....Allowable = 82.16 psi 82.16 psi

Vertical component of active lateral soil pressure IS NOT considered in the calculation of soil bearing

Load Factors

Building Code IBC 2018,ACI
Dead Load 1.400
Live Load 1.700
Earth, H 1.700
Wind, W 1.300
Seismic, E 1.000

Use menu item **Settings > Printing & Title Block**
to set these five lines of information
for your program.

Project Name/Number : 23-111

Title 11 FT top restrained

Dsgnr: gs

Description....

23-111

Page : 2
Date: 9 MAR 2023

This Wall in File: C:\ZVELT-ONE DRIVE\ZVELT JOBS\2023\23-111 Mercer Island Phan-Nguyen Res M5762A3FU

RetainPro (c) 1987-2019, Build 11.19.11.12
License : KW-06061901
License To : Zvelt Engineering Design, PLLC

Restrained Retaining Wall

Code: IBC 2018,ACI 318-14,TMS 402-16

Concrete Stem Rebar Area Details

Top Support	Vertical Reinforcing	Horizontal Reinforcing
As (based on applied moment) :	0 in2/ft	
(4/3) * As :	0 in2/ft	Min Stem T&S Reinf Area 2.640 in2
200bd/fy : 200(12)(7.5)/60000 :	0.3 in2/ft	Min Stem T&S Reinf Area per ft of stem Height : 0.240 in2/ft
0.0018bh : 0.0018(12)(10) :	0.216 in2/ft	Horizontal Reinforcing Options :
	=====	One layer of : Two layers of :
Required Area :	0.216 in2/ft	#4@ 10.00 in #4@ 20.00 in
Provided Area :	0.31 in2/ft	#5@ 15.50 in #5@ 31.00 in
Maximum Area :	1.2192 in2/ft	#6@ 22.00 in #6@ 44.00 in

Mmax Between Ends	Vertical Reinforcing	Horizontal Reinforcing
As (based on applied moment) :	0.1233 in2/ft	
(4/3) * As :	0.1644 in2/ft	Min Stem T&S Reinf Area 1.134 in2
200bd/fy : 200(12)(8)/60000 :	0.32 in2/ft	Min Stem T&S Reinf Area per ft of stem Height : 0.240 in2/ft
0.0018bh : 0.0018(12)(10) :	0.216 in2/ft	Horizontal Reinforcing Options :
	=====	One layer of : Two layers of :
Required Area :	0.216 in2/ft	#4@ 10.00 in #4@ 20.00 in
Provided Area :	0.31 in2/ft	#5@ 15.50 in #5@ 31.00 in
Maximum Area :	1.3005 in2/ft	#6@ 22.00 in #6@ 44.00 in

Base Support	Vertical Reinforcing	Horizontal Reinforcing
As (based on applied moment) :	0.2838 in2/ft	
(4/3) * As :	0.3784 in2/ft	Min Stem T&S Reinf Area 1.506 in2
200bd/fy : 200(12)(7.5)/60000 :	0.3 in2/ft	Min Stem T&S Reinf Area per ft of stem Height : 0.240 in2/ft
0.0018bh : 0.0018(12)(10) :	0.216 in2/ft	Horizontal Reinforcing Options :
	=====	One layer of : Two layers of :
Required Area :	0.3 in2/ft	#4@ 10.00 in #4@ 20.00 in
Provided Area :	0.31 in2/ft	#5@ 15.50 in #5@ 31.00 in
Maximum Area :	1.2192 in2/ft	#6@ 22.00 in #6@ 44.00 in

Footing Strengths & Dimensions

Toe Width	=	1.58 ft
Heel Width	=	2.17
Total Footing Width	=	3.75
Footing Thickness	=	12.00 in
Key Width	=	0.00 in
Key Depth	=	0.00 in
Key Distance from Toe	=	0.00 ft
f'c =	3,000 psi	Fy = 60,000 psi
Footing Concrete Density	=	150.00 pcf
Min. As %	=	0.0018
Cover @ Top	= 2.00 in	@ Btm.= 3.00 in

Footing Design Results

	Toe	Heel
Factored Pressure	= 1,875	1,875 psf
Mu' : Upward	= 2,350	1,667 ft-#
Mu' : Downward	= 263	1,991 ft-#
Mu: Design	= 2,087	324 ft-#
Actual 1-Way Shear	= 14.28	4.27 psi
Allow 1-Way Shear	= 82.16	82.16 psi

Other Acceptable Sizes & Spacings:

Toe: # 5 @ 12.00 in	-or-	Not req'd: Mu < phi*5*lambda*sqrt(f'c)*Sm
Heel: None Spec'd	-or-	Not req'd: Mu < phi*5*lambda*sqrt(f'c)*Sm
Key: No key defined	-or-	No key defined
Min footing T&S reinf Area		0.97 in2
Min footing T&S reinf Area per foot		0.26 in2 /ft
If one layer of horizontal bars:		If two layers of horizontal bars:
#4@ 9.26 in		#4@ 18.52 in
#5@ 14.35 in		#5@ 28.70 in
#6@ 20.37 in		#6@ 40.74 in

Use menu item Settings > Printing & Title Block
to set these five lines of information
for your program.

Project Name/Number : 23-111
Title 11 FT top restrained
Dsgnr: gs
Description....
23-111

Page : 3
Date: 9 MAR 2023

This Wall in File: C:\ZVELT-ONE DRIVE\ZVELT JOBS\2023\23-111 Mercer Island Phan-Nguyen Res M5762A3FU

RetainPro (c) 1987-2019, Build 11.19.11.12
License : KW-06061901
License To : Zvelt Engineering Design, PLLC

Restrained Retaining Wall

Code: IBC 2018,ACI 318-14,TMS 402-16

Summary of Forces on Footing : Slab RESISTS sliding, stem is FIXED at footing

Forces acting on footing for soil pressure

>>> Sliding Forces are restrained by the adjacent slab

Load & Moment Summary For Footing : For Soil Pressure Calcs

Moment @ Top of Footing Applied from Stem	=		=	-6,046.2 ft-#
Surcharge Over Heel	=	lbs	ft	ft-#
Adjacent Footing Load	=	lbs	ft	ft-#
Axial Dead Load on Stem	=	1,039.0 lbs	2.00 ft	2,077.7 ft-#
Soil Over Toe	=	lbs	ft	ft-#
Surcharge Over Toe	=	lbs	ft	ft-#
Stem Weight	=	1,375.0 lbs	2.00 ft	2,749.5 ft-#
Soil Over Heel	=	1,820.0 lbs	3.08 ft	5,611.1 ft-#
Footing Weight	=	562.5 lbs	1.87 ft	1,054.5 ft-#
Total Vertical Force	=	4,889.8 lbs	Base Moment =	5,446.5 ft-#

Soil Pressure Resulting Moment = 0.ft-#

Vertical component of active lateral soil pressure IS NOT considered in the calculation of Sliding Resistance.

**Blocked Diaphragm, A.B. Spacing
& Top Connection Due to Basement
Wall Loading**

**Phan-Nguyen Residence
Project #: 23-111**

BW top connection@Typical H=11 ft

Blocked Diaphragm

Reaction @ the top of the wall, V1	987	LB
Max allowable diaphragm shear, V2	298	PLF
Length of Diaphragm	68	FT
Width of Diaphragm	43	FT
Length of diaphragm from actual		
to max allowable, X1	10	FT
Block diaphragm	24	FT

Block to nearest 4 feet

Top Connection

Front to Back

wl/2	33558	
Shear at top of wall	780	
Try LS90 @ 12" OC	12	
	1.00	ft
Check Spacing	615	LB
Greater than	780	Therefore OK

LS50 =	520	LB
LS70 =	580	LB
LS90 =	615	LB
LTP5=	470	LB

AB Spacing (5/8" DIA X 8")

2x sill plate	Zpara	1040	LB
2x Spacing	1.05	FT	
	13	IN	

3x sill plate	Zpara	1090	LB
3X Spacing	1.10	FT	
	13	IN	

Use menu item **Settings > Printing & Title Block**
to set these five lines of information
for your program.

Project Name/Number : 23-111

Title 11'-0" CW W/Slab

Dsgnr: GS

Description....
23-111

Page : 1
Date: 9 MAR 2023

This Wall in File: C:\ZVELT-ONE DRIVE\ZVELT JOBS\2023\23-111 Mercer Island Phan-Nguyen Res M5762A3FU

RetainPro (c) 1987-2019, Build 11.19.11.12

License : KW-06061901

License To : Zvelt Engineering Design, PLLC

Cantilevered Retaining Wall

Code: IBC 2018,ACI 318-14,TMS 402-16

Criteria

Retained Height = 10.50 ft
Wall height above soil = 0.50 ft
Slope Behind Wall = 0.00
Height of Soil over Toe = 0.00 in
Water height over heel = 0.0 ft

Soil Data

Allow Soil Bearing = 1,500.0 psf
Equivalent Fluid Pressure Method
Active Heel Pressure = 35.0 psf/ft

Passive Pressure = 300.0 psf/ft
Soil Density, Heel = 130.00 pcf
Soil Density, Toe = 0.00 pcf
Footings||Soil Friction = 0.350
Soil height to ignore for passive pressure = 0.00 in

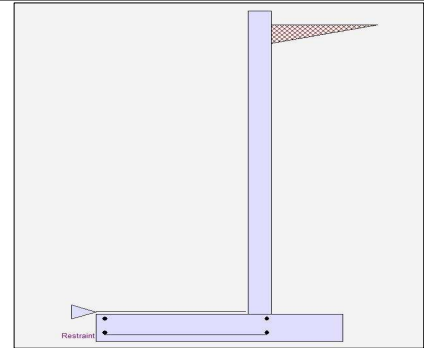

Surcharge Loads

Surcharge Over Heel = 70.0 psf
NOT Used To Resist Sliding & Overturning
Surcharge Over Toe = 0.0
NOT Used for Sliding & Overturning

Lateral Load Applied to Stem

Lateral Load = 84.0 #/ft
...Height to Top = 10.50 ft
...Height to Bottom = 0.00 ft
Load Type = Seismic (E)
(Service Level)
Wind on Exposed Stem = 0.0 psf
(Service Level)

Adjacent Footing Load

Adjacent Footing Load = 0.0 lbs
Footing Width = 0.00 ft
Eccentricity = 0.00 in
Wall to Ftg CL Dist = 0.00 ft
Footing Type Line Load
Base Above/Below Soil at Back of Wall = 0.0 ft
Poisson's Ratio = 0.300

Axial Load Applied to Stem

Axial Dead Load = 339.0 lbs
Axial Live Load = 713.0 lbs
Axial Load Eccentricity = 0.0 in

Stem Weight Seismic Load

F_p / W_p Weight Multiplier = 0.050 g Added seismic base force 38.5 lbs

Design Summary

Wall Stability Ratios

Overturning = 1.77 OK
Slab Resists All Sliding !

Total Bearing Load = 6,068 lbs
...resultant ecc. = 10.42 in

Soil Pressure @ Toe = 1,465 psf OK
Soil Pressure @ Heel = 231 psf OK
Allowable = 1,500 psf
Soil Pressure Less Than Allowable

ACI Factored @ Toe = 2,100 psf
ACI Factored @ Heel = 331 psf

Footing Shear @ Toe = 52.0 psi OK
Footing Shear @ Heel = 28.7 psi OK
Allowable = 82.2 psi

Sliding Calcs

Lateral Sliding Force = 3,451.6 lbs

Vertical component of active lateral soil pressure IS NOT considered in the calculation of soil bearing

Load Factors

Building Code IBC 2018,ACI
Dead Load 1.400
Live Load 1.700
Earth, H 1.700
Wind, W 1.300
Seismic, E 1.000

Stem Construction

Design Height Above Ftg ft = 0.00
Wall Material Above "Ht" = Concrete
Design Method = LRFD
Thickness = 8.00
Rebar Size = # 6
Rebar Spacing = 6.00
Rebar Placed at = 6.5 in

Design Data

fb/FB + fa/Fa = 0.814

Total Force @ Section

Service Level lbs =
Strength Level lbs = 4,553.3

Moment....Actual

Service Level ft-# =
Strength Level ft-# = 18,178.9
Moment....Allowable = 22,313.3

Shear.....Actual

Service Level psi =
Strength Level psi = 58.4
Shear.....Allowable psi = 82.2

Masonry Data

Anet (Masonry) in2 =
Rebar Depth 'd' in = 6.50

Masonry Data

f'm psi =
Fs psi =
Solid Grouting =
Modular Ratio 'n' =
Wall Weight psf = 100.0

Short Term Factor =
Equiv. Solid Thick. =
Masonry Block Type = Medium Weight
Masonry Design Method = ASD

Concrete Data

f'c psi = 3,000.0
Fy psi = 60,000.0

Use menu item Settings > Printing & Title Block
to set these five lines of information
for your program.

Project Name/Number : 23-111

Title 11'-0" CW W/Slab

Dsgnr: GS

Description....
23-111

Page : 2

Date: 9 MAR 2023

This Wall in File: C:\ZVELT-ONE DRIVE\ZVELT JOBS\2023\23-111 Mercer Island Phan-Nguyen Res M5762A3FU

RetainPro (c) 1987-2019, Build 11.19.11.12

License : KW-06061901

License To : Zvelt Engineering Design, PLLC

Cantilevered Retaining Wall

Code: IBC 2018,ACI 318-14,TMS 402-16

Concrete Stem Rebar Area Details

Bottom Stem	Vertical Reinforcing	Horizontal Reinforcing
As (based on applied moment) :	0.6535 in ² /ft	
(4/3) * As :	0.8714 in ² /ft	Min Stem T&S Reinf Area 2.112 in ²
200bd/fy : 200(12)(6.5)/60000 :	0.26 in ² /ft	Min Stem T&S Reinf Area per ft of stem Height : 0.192 in ² /ft
0.0018bh : 0.0018(12)(8) :	0.1728 in ² /ft	Horizontal Reinforcing Options :
	=====	One layer of : Two layers of :
Required Area :	0.6535 in ² /ft	#4@ 12.50 in #4@ 25.00 in
Provided Area :	0.88 in ² /ft	#5@ 19.38 in #5@ 38.75 in
Maximum Area :	1.0567 in ² /ft	#6@ 27.50 in #6@ 55.00 in

Footing Data

Toe Width	=	4.41 ft
Heel Width	=	2.75
Total Footing Width	=	7.16
Footing Thickness	=	12.00 in
Key Width	=	0.00 in
Key Depth	=	0.00 in
Key Distance from Toe	=	1.25 ft
f'c =	3,000 psi	Fy = 60,000 psi
Footing Concrete Density	=	150.00 pcf
Min. As %	=	0.0018
Cover @ Top	2.00	@ Btm.= 3.00 in

Footing Design Results

		<u>Toe</u>	<u>Heel</u>
Factored Pressure	=	2,100	331 psf
Mu' : Upward	=	202,618	1,089 ft-#
Mu' : Downward	=	24,505	4,856 ft-#
Mu: Design	=	9,775	3,767 ft-#
Actual 1-Way Shear	=	51.98	28.67 psi
Allow 1-Way Shear	=	82.16	43.82 psi
Toe Reinforcing	=	# 6 @ 6.00 in	
Heel Reinforcing	=	None Spec'd	
Key Reinforcing	=	None Spec'd	
Footing Torsion, Tu	=		0.00 ft-lbs
Footing Allow. Torsion, phi Tu	=		0.00 ft-lbs

If torsion exceeds allowable, provide supplemental design for footing torsion.

Other Acceptable Sizes & Spacings

Toe: #4@ 5.94 in, #5@ 9.22 in, #6@ 13.09 in, #7@ 17.85 in, #8@ 23.50 in, #9@ 29.
Heel: Not req'd: Mu < phi*5*lambda*sqrt(f'c)*Sm
Key: No key defined

Min footing T&S reinf Area	1.86	in ²
Min footing T&S reinf Area per foot	0.26	in ² /ft
If one layer of horizontal bars:		If two layers of horizontal bars:
#4@ 9.26 in		#4@ 18.52 in
#5@ 14.35 in		#5@ 28.70 in
#6@ 20.37 in		#6@ 40.74 in

Use menu item **Settings > Printing & Title Block** to set these five lines of information for your program.

Project Name/Number : 23-111

Title 11'-0" CW W/Slab

Dsgnr: GS

Description....

23-111

Page : 3

Date: 9 MAR 2023

This Wall in File: C:\ZVELT-ONE DRIVE\ZVELT JOBS\2023\23-111 Mercer Island Phan-Nguyen Res M5762A3FU

RetainPro (c) 1987-2019, Build 11.19.11.12

License : KW-06061901

License To : Zvelt Engineering Design, PLLC

Cantilevered Retaining Wall

Code: IBC 2018,ACI 318-14,TMS 402-16

Summary of Overturning & Resisting Forces & Moments

ItemOVERTURNING.....		RESISTING.....			
	Force lbs	Distance ft	Moment ft-#	Force lbs	Distance ft	Moment ft-#	
HL Act Pres (ab water tbl)	2,314.4	3.83	8,871.8	Soil Over HL (ab. water tbl)	2,842.4	6.12	17,389.2
HL Act Pres (be water tbl)				Soil Over HL (bel. water tbl)		6.12	17,389.2
Hydrostatic Force				Watre Table			
Buoyant Force =				Sloped Soil Over Heel =			
Surcharge over Heel =	216.7	5.75	1,246.2	Surcharge Over Heel =			
Surcharge Over Toe =				Adjacent Footing Load =			
Adjacent Footing Load =				Axial Dead Load on Stem =	1,052.0	4.74	1,608.0
Added Lateral Load =	882.0	6.25	5,512.5	* Axial Live Load on Stem =	713.0	4.74	3,382.0
Load @ Stem Above Soil =				Soil Over Toe =			
=				Surcharge Over Toe =			
Seismic Stem Self Wt	38.5	6.50	250.3	Stem Weight(s) =	1,100.0	4.74	5,217.7
Total	3,451.6	O.T.M. =	15,880.7	Earth @ Stem Transitions =			
Resisting/Overturning Ratio		=	1.77	Footing Weight =	1,073.9	3.58	3,843.8
Vertical Loads used for Soil Pressure =		6,068.2	lbs	Key Weight =		1.25	
				Vert. Component =			
				Total =	5,355.2	lbs R.M.=	28,058.7

* Axial live load NOT included in total displayed, or used for overturning resistance, but is included for soil pressure calculation.

If seismic is included, the OTM and sliding ratios may be 1.1 per section 1807.2.3 of IBC.

Vertical component of active lateral soil pressure IS NOT considered in the calculation of Sliding Resistance.

Vertical component of active lateral soil pressure IS NOT considered in the calculation of Overturning Resistance.

Tilt

Horizontal Deflection at Top of Wall due to settlement of soil

(Deflection due to wall bending not considered)

Soil Spring Reaction Modulus 250.0 pci

Horizontal Defl @ Top of Wall (approximate only) 0.063 in

Use menu item **Settings > Printing & Title Block**
to set these five lines of information
for your program.

Project Name/Number : 23-111

Title 4'-0" CW W/Slab
Dsgnr: GS
Description....
23-111

Page : 1
Date: 9 MAR 2023

This Wall in File: C:\ZVELT-ONE DRIVE\ZVELT JOBS\2023\23-111 Mercer Island Phan-Nguyen Res M5762A3FU

RetainPro (c) 1987-2019, Build 11.19.11.12
License : KW-06061901
License To : Zvelt Engineering Design, PLLC

Cantilevered Retaining Wall

Code: IBC 2018, ACI 318-14, TMS 402-16

Criteria

Retained Height = 3.50 ft
Wall height above soil = 0.50 ft
Slope Behind Wall = 0.00
Height of Soil over Toe = 0.00 in
Water height over heel = 0.0 ft

Soil Data

Allow Soil Bearing = 1,500.0 psf
Equivalent Fluid Pressure Method
Active Heel Pressure = 35.0 psf/ft
=
Passive Pressure = 300.0 psf/ft
Soil Density, Heel = 130.00 pcf
Soil Density, Toe = 0.00 pcf
Footings||Soil Friction = 0.350
Soil height to ignore for passive pressure = 0.00 in

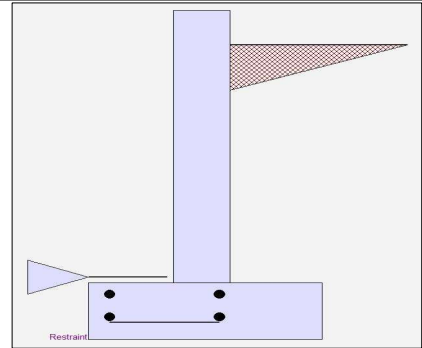

Surcharge Loads

Surcharge Over Heel = 70.0 psf
NOT Used To Resist Sliding & Overturning
Surcharge Over Toe = 0.0
NOT Used for Sliding & Overturning

Lateral Load Applied to Stem

Lateral Load = 28.0 #/ft
...Height to Top = 3.50 ft
...Height to Bottom = 0.00 ft
Load Type = Seismic (E)
(Service Level)
Wind on Exposed Stem = 0.0 psf
(Service Level)

Adjacent Footing Load

Adjacent Footing Load = 0.0 lbs
Footing Width = 0.00 ft
Eccentricity = 0.00 in
Wall to Ftg CL Dist = 0.00 ft
Footing Type Line Load
Base Above/Below Soil at Back of Wall = 0.0 ft
Poisson's Ratio = 0.300

Axial Load Applied to Stem

Axial Dead Load = 419.0 lbs
Axial Live Load = 620.0 lbs
Axial Load Eccentricity = 0.0 in

Stem Weight Seismic Load

F_p / W_p Weight Multiplier = 0.050 g Added seismic base force 14.0 lbs

Design Summary

Wall Stability Ratios

Overturning = 2.81 OK
Slab Resists All Sliding !

Total Bearing Load = 2,276 lbs
...resultant ecc. = 2.25 in

Soil Pressure @ Toe = 1,166 psf OK
Soil Pressure @ Heel = 489 psf OK
Allowable = 1,500 psf
Soil Pressure Less Than Allowable

ACI Factored @ Toe = 1,686 psf
ACI Factored @ Heel = 708 psf

Footing Shear @ Toe = 8.4 psi OK
Footing Shear @ Heel = 0.3 psi OK
Allowable = 82.2 psi

Sliding Calcs

Lateral Sliding Force = 522.3 lbs

Vertical component of active lateral soil pressure IS NOT considered in the calculation of soil bearing

Load Factors

Building Code IBC 2018, ACI
Dead Load 1.400
Live Load 1.700
Earth, H 1.700
Wind, W 1.300
Seismic, E 1.000

Stem Construction

Design Height Above Ftg ft = 0.00
Wall Material Above "Ht" = Concrete
Design Method = LRFD
Thickness = 8.00
Rebar Size = # 5
Rebar Spacing = 16.00
Rebar Placed at = 6.5 in

Design Data

fb/FB + fa/Fa = 0.126

Total Force @ Section

Service Level lbs =
Strength Level lbs = 594.6

Moment....Actual

Service Level ft-# =
Strength Level ft-# = 832.9

Moment....Allowable = 6,561.4

Shear.....Actual

Service Level psi =
Strength Level psi = 7.6

Shear....Allowable psi = 82.2

Anet (Masonry) in2 =

Rebar Depth 'd' in = 6.50

Masonry Data

f'm psi =

Fs psi =

Solid Grouting =

Modular Ratio 'n' =

Wall Weight psf = 100.0

Short Term Factor =

Equiv. Solid Thick. =

Masonry Block Type = Medium Weight

Masonry Design Method = ASD

Concrete Data

f'c psi = 3,000.0

Fy psi = 60,000.0

Use menu item Settings > Printing & Title Block
to set these five lines of information
for your program.

Project Name/Number : 23-111

Title 4'-0" CW W/Slab

Dsgnr: GS

Description....

23-111

Page : 2

Date: 9 MAR 2023

This Wall in File: C:\ZVELT-ONE DRIVE\ZVELT JOBS\2023\23-111 Mercer Island Phan-Nguyen Res M5762A3FU

RetainPro (c) 1987-2019, Build 11.19.11.12

License : KW-06061901

License To : Zvelt Engineering Design, PLLC

Cantilevered Retaining Wall

Code: IBC 2018,ACI 318-14,TMS 402-16

Concrete Stem Rebar Area Details

Bottom Stem	Vertical Reinforcing	Horizontal Reinforcing
As (based on applied moment) :	0.0299 in ² /ft	
(4/3) * As :	0.0399 in ² /ft	Min Stem T&S Reinf Area 0.768 in ²
200bd/fy : 200(12)(6.5)/60000 :	0.26 in ² /ft	Min Stem T&S Reinf Area per ft of stem Height : 0.192 in ² /ft
0.0018bh : 0.0018(12)(8) :	0.1728 in ² /ft	Horizontal Reinforcing Options :
	=====	One layer of : Two layers of :
Required Area :	0.1728 in ² /ft	#4@ 12.50 in #4@ 25.00 in
Provided Area :	0.2325 in ² /ft	#5@ 19.38 in #5@ 38.75 in
Maximum Area :	1.0567 in ² /ft	#6@ 27.50 in #6@ 55.00 in

Footing Data

Toe Width	=	1.00 ft
Heel Width	=	1.75
Total Footing Width	=	2.75
Footing Thickness	=	10.00 in
Key Width	=	0.00 in
Key Depth	=	0.00 in
Key Distance from Toe	=	1.00 ft
f'c =	3,000 psi	Fy = 60,000 psi
Footing Concrete Density	=	150.00 pcf
Min. As %	=	0.0018
Cover @ Top	2.00	@ Btm.= 3.00 in

Footing Design Results

	Toe	Heel
Factored Pressure	= 1,686	708 psf
Mu' : Upward	= 9,406	491 ft-#
Mu' : Downward	= 1,050	546 ft-#
Mu: Design	= 511	55 ft-#
Actual 1-Way Shear	= 8.40	0.34 psi
Allow 1-Way Shear	= 82.16	43.82 psi
Toe Reinforcing	= # 5 @ 16.00 in	
Heel Reinforcing	= None Spec'd	
Key Reinforcing	= None Spec'd	
Footing Torsion, Tu	=	0.00 ft-lbs
Footing Allow. Torsion, phi Tu	=	0.00 ft-lbs

If torsion exceeds allowable, provide supplemental design for footing torsion.

Other Acceptable Sizes & Spacings

Toe: #4@ 11.10 in, #5@ 17.21 in, #6@ 24.43 in, #7@ 33.32 in, #8@ 43.88 in, #9@ 5
Heel: Not req'd: Mu < phi*5*lambda*sqrt(f'c)*Sm
Key: No key defined

Min footing T&S reinf Area	0.59 in ²
Min footing T&S reinf Area per foot	0.22 in ² /ft
If one layer of horizontal bars:	If two layers of horizontal bars:
#4@ 11.11 in	#4@ 22.22 in
#5@ 17.22 in	#5@ 34.44 in
#6@ 24.44 in	#6@ 48.89 in

Use menu item **Settings > Printing & Title Block** to set these five lines of information for your program.

Project Name/Number : 23-111

Title 4'-0" CW W/Slab

Dsgnr: GS

Description....

23-111

Page : 3

Date: 9 MAR 2023

This Wall in File: C:\ZVELT-ONE DRIVE\ZVELT JOBS\2023\23-111 Mercer Island Phan-Nguyen Res M5762A3FU

RetainPro (c) 1987-2019, Build 11.19.11.12

License : KW-06061901

License To : Zvelt Engineering Design, PLLC

Cantilevered Retaining Wall

Code: IBC 2018,ACI 318-14,TMS 402-16

Summary of Overturning & Resisting Forces & Moments

ItemOVERTURNING.....		RESISTING.....			
	Force lbs	Distance ft	Moment ft-#	Force lbs	Distance ft	Moment ft-#	
HL Act Pres (ab water tbl)	328.6	1.44	474.7	Soil Over HL (ab. water tbl)	492.9	2.21	1,088.5
HL Act Pres (be water tbl)				Soil Over HL (bel. water tbl)		2.21	1,088.5
Hydrostatic Force				Watre Table			
Buoyant Force =				Sloped Soil Over Heel =			
Surcharge over Heel =	81.7	2.17	176.9	Surcharge Over Heel =			
Surcharge Over Toe =				Adjacent Footing Load =			
Adjacent Footing Load =				Axial Dead Load on Stem =	1,039.0	1.33	558.7
Added Lateral Load =	98.0	2.58	253.2	* Axial Live Load on Stem =	620.0	1.33	826.7
Load @ Stem Above Soil =				Soil Over Toe =			
=				Surcharge Over Toe =			
Seismic Stem Self Wt	14.0	2.83	39.7	Stem Weight(s) =	400.0	1.33	533.3
Total =	522.3	O.T.M. =	944.4	Earth @ Stem Transitions =			
Resisting/Overturning Ratio =		2.81		Footing Weight =	343.8	1.38	472.7
Vertical Loads used for Soil Pressure =		2,275.7 lbs		Key Weight =		1.00	
				Vert. Component =			
				Total =	1,655.7 lbs	R.M.=	2,653.2

* Axial live load NOT included in total displayed, or used for overturning resistance, but is included for soil pressure calculation.

If seismic is included, the OTM and sliding ratios may be 1.1 per section 1807.2.3 of IBC.

Vertical component of active lateral soil pressure IS NOT considered in the calculation of Sliding Resistance.

Vertical component of active lateral soil pressure IS NOT considered in the calculation of Overturning Resistance.

Tilt

Horizontal Deflection at Top of Wall due to settlement of soil

(Deflection due to wall bending not considered)

Soil Spring Reaction Modulus 250.0 pci

Horizontal Defl @ Top of Wall (approximate only) 0.047 in

Use menu item **Settings > Printing & Title Block** to set these five lines of information for your program.

Project Name/Number : 23-111-Site r

Title 3'-0" CW W/Slab

Dsgnr: GS

Description....
23-111

Page : 1
Date: 28 MAR 2023

This Wall in File: C:\ZVELT-ONE DRIVE\ZVELT JOBS\2023\23-111 Mercer Island Phan-Nguyen Res M5762A3FU

RetainPro (c) 1987-2019, Build 11.19.11.12
License : KW-06061901
License To : Zvelt Engineering Design, PLLC

Cantilevered Retaining Wall

Code: IBC 2018, ACI 318-14, TMS 402-16

Criteria

Retained Height = 2.50 ft
Wall height above soil = 0.50 ft
Slope Behind Wall = 0.00
Height of Soil over Toe = 0.00 in
Water height over heel = 0.0 ft

Soil Data

Allow Soil Bearing = 1,500.0 psf
Equivalent Fluid Pressure Method
Active Heel Pressure = 35.0 psf/ft
Passive Pressure = 350.0 psf/ft
Soil Density, Heel = 130.00 pcf
Soil Density, Toe = 0.00 pcf
Footings|Soil Friction = 0.350
Soil height to ignore for passive pressure = 0.00 in

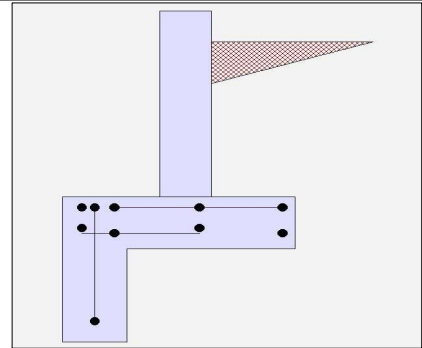

Surcharge Loads

Surcharge Over Heel = 70.0 psf
NOT Used To Resist Sliding & Overturning
Surcharge Over Toe = 0.0
NOT Used for Sliding & Overturning

Lateral Load Applied to Stem

Lateral Load = 20.0 #/ft
...Height to Top = 2.50 ft
...Height to Bottom = 0.00 ft
Load Type = Seismic (E)
(Service Level)
Wind on Exposed Stem = 0.0 psf
(Service Level)

Adjacent Footing Load

Adjacent Footing Load = 0.0 lbs
Footing Width = 0.00 ft
Eccentricity = 0.00 in
Wall to Ftg CL Dist = 0.00 ft
Footing Type = Line Load
Base Above/Below Soil at Back of Wall = 0.0 ft
Poisson's Ratio = 0.300

Axial Load Applied to Stem

Axial Dead Load = 0.0 lbs
Axial Live Load = 0.0 lbs
Axial Load Eccentricity = 0.0 in

Stem Weight Seismic Load

F_p / W_p Weight Multiplier = 0.050 g Added seismic base force 10.5 lbs

Design Summary

Wall Stability Ratios

Overturning = 4.41 OK
Sliding = 4.34 OK

Total Bearing Load = 1,215 lbs
...resultant ecc. = 1.02 in

Soil Pressure @ Toe = 474 psf OK
Soil Pressure @ Heel = 336 psf OK
Allowable = 1,500 psf
Soil Pressure Less Than Allowable

ACI Factored @ Toe = 705 psf
ACI Factored @ Heel = 499 psf
Footing Shear @ Toe = 4.6 psi OK
Footing Shear @ Heel = 2.6 psi OK
Allowable = 82.2 psi

Sliding Calcs

Lateral Sliding Force = 317.8 lbs
less 100% Passive Force = - 952.8 lbs
less 100% Friction Force = - 425.1 lbs
Added Force Req'd = 0.0 lbs OK
...for 1.5 Stability = 0.0 lbs OK

Vertical component of active lateral soil pressure IS NOT considered in the calculation of soil bearing

Load Factors

Building Code IBC 2018, ACI
Dead Load 1.400
Live Load 1.700
Earth, H 1.700
Wind, W 1.300
Seismic, E 1.000

Stem Construction

Design Height Above Ftg ft = 0.00
Wall Material Above "Ht" = Concrete
Design Method = LRFD
Thickness = 8.00
Rebar Size = # 5
Rebar Spacing = 12.00
Rebar Placed at = Edge

Design Data

fb/FB + fa/Fa = 0.040

Total Force @ Section

Service Level lbs =
Strength Level lbs = 331.0

Moment....Actual

Service Level ft-# =
Strength Level ft-# = 340.1
Moment....Allowable = 8,206.3

Shear.....Actual

Service Level psi =
Strength Level psi = 4.5
Shear.....Allowable psi = 82.2

Masonry Data

Anet (Masonry) in2 =

Rebar Depth 'd' in = 6.19

Masonry Data

f'm psi =

Fs psi =

Solid Grouting =

Modular Ratio 'n' =

Wall Weight psf = 100.0

Short Term Factor =

Equiv. Solid Thick. =

Masonry Block Type = Medium Weight

Masonry Design Method = ASD

Concrete Data

f'c psi = 3,000.0

Fy psi = 60,000.0

Use menu item Settings > Printing & Title Block
to set these five lines of information
for your program.

Project Name/Number : 23-111-Site r
Title 3'-0" CW W/Slab
Dsgnr: GS
Description....
23-111

Page : 2
Date: 28 MAR 2023

This Wall in File: C:\ZVELT-ONE DRIVE\ZVELT JOBS\2023\23-111 Mercer Island Phan-Nguyen Res M5762A3FU

RetainPro (c) 1987-2019, Build 11.19.11.12
License : KW-06061901
License To : Zvelt Engineering Design, PLLC

Cantilevered Retaining Wall

Code: IBC 2018, ACI 318-14, TMS 402-16

Concrete Stem Rebar Area Details

Bottom Stem	Vertical Reinforcing	Horizontal Reinforcing
As (based on applied moment) :	0.0129 in ² /ft	
(4/3) * As :	0.0172 in ² /ft	Min Stem T&S Reinf Area 0.576 in ²
200bd/fy : 200(12)(6.1875)/60000 :	0.2475 in ² /ft	Min Stem T&S Reinf Area per ft of stem Height : 0.192 in ² /ft
0.0018bh : 0.0018(12)(8) :	0.1728 in ² /ft	Horizontal Reinforcing Options :
	=====	One layer of : Two layers of :
Required Area :	0.1728 in ² /ft	#4@ 12.50 in #4@ 25.00 in
Provided Area :	0.31 in ² /ft	#5@ 19.38 in #5@ 38.75 in
Maximum Area :	1.0059 in ² /ft	#6@ 27.50 in #6@ 55.00 in

Footing Data

Toe Width	=	1.25 ft
Heel Width	=	1.75
Total Footing Width	=	3.00
Footing Thickness	=	10.00 in
Key Width	=	10.00 in
Key Depth	=	18.00 in
Key Distance from Toe	=	0.00 ft
f'c =	3,000 psi	Fy = 60,000 psi
Footing Concrete Density	=	150.00 pcf
Min. As %	=	0.0018
Cover @ Top	2.00	@ Btm.= 3.00 in

Footing Design Results

	Toe	Heel
Factored Pressure	= 705	499 psf
Mu' : Upward	= 6,342	308 ft-#
Mu' : Downward	= 1,641	440 ft-#
Mu: Design	= 334	132 ft-#
Actual 1-Way Shear	= 4.59	2.56 psi
Allow 1-Way Shear	= 82.16	82.16 psi
Toe Reinforcing	= # 5 @ 12.00 in	
Heel Reinforcing	= # 4 @ 9.25 in	
Key Reinforcing	= # 4 @ 6.00 in	
Footing Torsion, Tu	=	0.00 ft-lbs
Footing Allow. Torsion, phi Tu	=	0.00 ft-lbs

If torsion exceeds allowable, provide supplemental design for footing torsion.

Other Acceptable Sizes & Spacings

Toe: #4@ 11.10 in, #5@ 17.21 in, #6@ 24.43 in, #7@ 33.32 in, #8@ 43.88 in, #9@ 5
Heel: #4@ 11.10 in, #5@ 17.21 in, #6@ 24.43 in, #7@ 33.32 in, #8@ 43.88 in, #9@ 5
Key: #4@ 11.1 in, #5@ 17.21 in, #6@ 18 in, #7@ 18 in, #8@ 18

Min footing T&S reinf Area 0.65 in²
Min footing T&S reinf Area per foot 0.22 in²/ft

If one layer of horizontal bars: If two layers of horizontal bars:
#4@ 11.11 in #4@ 22.22 in
#5@ 17.22 in #5@ 34.44 in
#6@ 24.44 in #6@ 48.89 in

Use menu item **Settings > Printing & Title Block** to set these five lines of information for your program.

Project Name/Number : 23-111-Site r
 Title 3'-0" CW W/Slab
 Dsgnr: GS
 Description....
 23-111

Page : 3
 Date: 28 MAR 2023

This Wall in File: C:\ZVELT-ONE DRIVE\ZVELT JOBS\2023\23-111 Mercer Island Phan-Nguyen Res M5762A3FU

RetainPro (c) 1987-2019, Build 11.19.11.12
 License : KW-06061901
 License To : Zvelt Engineering Design, PLLC

Cantilevered Retaining Wall

Code: IBC 2018,ACI 318-14,TMS 402-16

Summary of Overturning & Resisting Forces & Moments

ItemOVERTURNING.....		RESISTING.....			
	Force lbs	Distance ft	Moment ft-#	Force lbs	Distance ft	Moment ft-#	
HL Act Pres (ab water tbl)	194.4	1.11	216.0	Soil Over HL (ab. water tbl)	352.1	2.46	865.5
HL Act Pres (be water tbl)				Soil Over HL (bel. water tbl)		2.46	865.5
Hydrostatic Force				Watre Table			
Buoyant Force =				Sloped Soil Over Heel =			
Surcharge over Heel =	62.8	1.67	104.7	Surcharge Over Heel =			
Surcharge Over Toe =				Adjacent Footing Load =			
Adjacent Footing Load =				Axial Dead Load on Stem =			
Added Lateral Load =	50.0	2.08	104.2	* Axial Live Load on Stem =			
Load @ Stem Above Soil =				Soil Over Toe =			
				Surcharge Over Toe =			
Seismic Stem Self Wt	10.5	2.33	24.5	Stem Weight(s) =	300.0	1.58	475.0
Total	= 317.8	O.T.M. =	449.4	Earth @ Stem Transitions =			
Resisting/Overturning Ratio		= 4.41		Footing Weight =	375.0	1.50	562.5
Vertical Loads used for Soil Pressure =		1,214.6 lbs		Key Weight =	187.5	0.42	78.1
				Vert. Component =			
				Total =	1,214.6 lbs	R.M.=	1,981.2

* Axial live load NOT included in total displayed, or used for overturning resistance, but is included for soil pressure calculation.

If seismic is included, the OTM and sliding ratios may be 1.1 per section 1807.2.3 of IBC.

Vertical component of active lateral soil pressure IS NOT considered in the calculation of Sliding Resistance.

Vertical component of active lateral soil pressure IS NOT considered in the calculation of Overturning Resistance.

Tilt

Horizontal Deflection at Top of Wall due to settlement of soil

(Deflection due to wall bending not considered)

Soil Spring Reaction Modulus 250.0 pci
 Horizontal Defl @ Top of Wall (approximate only) 0.013 in

Use menu item **Settings > Printing & Title Block** to set these five lines of information for your program.

Project Name/Number : 23-111-Site r

Title 5'-0" CW W/Slab

Dsgnr: GS

Description....
23-111

Page : 1
Date: 28 MAR 2023

This Wall in File: C:\ZVELT-ONE DRIVE\ZVELT JOBS\2023\23-111 Mercer Island Phan-Nguyen Res M5762A3FU

RetainPro (c) 1987-2019, Build 11.19.11.12
License : KW-06061901
License To : Zvelt Engineering Design, PLLC

Cantilevered Retaining Wall

Code: IBC 2018, ACI 318-14, TMS 402-16

Criteria

Retained Height = 4.50 ft
Wall height above soil = 0.50 ft
Slope Behind Wall = 0.00
Height of Soil over Toe = 0.00 in
Water height over heel = 0.0 ft

Soil Data

Allow Soil Bearing = 1,500.0 psf
Equivalent Fluid Pressure Method
Active Heel Pressure = 35.0 psf/ft
=
Passive Pressure = 350.0 psf/ft
Soil Density, Heel = 130.00 pcf
Soil Density, Toe = 0.00 pcf
Footings||Soil Friction = 0.350
Soil height to ignore for passive pressure = 0.00 in

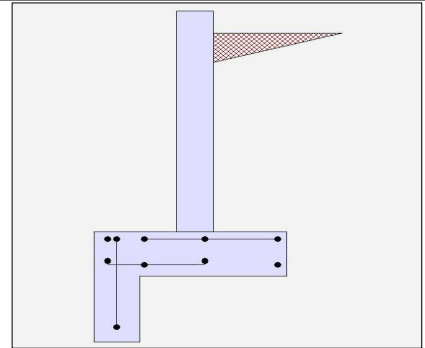

Surcharge Loads

Surcharge Over Heel = 70.0 psf
NOT Used To Resist Sliding & Overturning
Surcharge Over Toe = 0.0
NOT Used for Sliding & Overturning

Lateral Load Applied to Stem

Lateral Load = 68.0 #/ft
...Height to Top = 4.50 ft
...Height to Bottom = 0.00 ft
Load Type = Seismic (E)
(Service Level)
Wind on Exposed Stem = 0.0 psf
(Service Level)

Adjacent Footing Load

Adjacent Footing Load = 0.0 lbs
Footing Width = 0.00 ft
Eccentricity = 0.00 in
Wall to Ftg CL Dist = 0.00 ft
Footing Type = Line Load
Base Above/Below Soil at Back of Wall = 0.0 ft
Poisson's Ratio = 0.300

Axial Load Applied to Stem

Axial Dead Load = 0.0 lbs
Axial Live Load = 0.0 lbs
Axial Load Eccentricity = 0.0 in

Stem Weight Seismic Load

F_p / W_p Weight Multiplier = 0.050 g Added seismic base force 17.5 lbs

Design Summary

Wall Stability Ratios

Overturning = 1.78 OK
Sliding = 1.87 OK

Total Bearing Load = 1,993 lbs
...resultant ecc. = 8.49 in

Soil Pressure @ Toe = 1,274 psf OK
Soil Pressure @ Heel = 0 psf OK
Allowable = 1,500 psf
Soil Pressure Less Than Allowable

ACI Factored @ Toe = 1,868 psf
ACI Factored @ Heel = 0 psf

Footing Shear @ Toe = 11.0 psi OK
Footing Shear @ Heel = 11.0 psi OK
Allowable = 82.2 psi

Sliding Calcs

Lateral Sliding Force = 956.5 lbs
less 100% Passive Force = - 1,093.8 lbs
less 100% Friction Force = - 697.4 lbs
Added Force Req'd = 0.0 lbs OK
...for 1.5 Stability = 0.0 lbs OK

Vertical component of active lateral soil pressure IS NOT considered in the calculation of soil bearing

Load Factors

Building Code IBC 2018, ACI
Dead Load 1.400
Live Load 1.700
Earth, H 1.700
Wind, W 1.300
Seismic, E 1.000

Stem Construction

Design Height Above Ftg ft = 0.00
Wall Material Above "Ht" = Concrete
Design Method = LRFD
Thickness = 8.00
Rebar Size = # 5
Rebar Spacing = 12.00
Rebar Placed at = Edge

Design Data

fb/FB + fa/Fa = 0.240

Total Force @ Section

Service Level lbs =
Strength Level lbs = 1,077.6

Moment....Actual

Service Level ft-# =
Strength Level ft-# = 1,979.0
Moment....Allowable = 8,206.3

Shear.....Actual

Service Level psi =
Strength Level psi = 14.5
Shear.....Allowable psi = 82.2

Masonry Data

Anet (Masonry) in2 =
Rebar Depth 'd' in = 6.19

Masonry Data

f'm psi =
Fs psi =
Solid Grouting =
Modular Ratio 'n' =
Wall Weight psf = 100.0

Short Term Factor =
Equiv. Solid Thick. =
Masonry Block Type = Medium Weight
Masonry Design Method = ASD

Concrete Data

f'c psi = 3,000.0
Fy psi = 60,000.0

Use menu item Settings > Printing & Title Block
to set these five lines of information
for your program.

Project Name/Number : 23-111-Site r
Title 5'-0" CW W/Slab
Dsgnr: GS
Description....
23-111

Page : 2
Date: 28 MAR 2023

This Wall in File: C:\ZVELT-ONE DRIVE\ZVELT JOBS\2023\23-111 Mercer Island Phan-Nguyen Res M5762A3FU

RetainPro (c) 1987-2019, Build 11.19.11.12
License : KW-06061901
License To : Zvelt Engineering Design, PLLC

Cantilevered Retaining Wall

Code: IBC 2018, ACI 318-14, TMS 402-16

Concrete Stem Rebar Area Details

Bottom Stem	Vertical Reinforcing	Horizontal Reinforcing
As (based on applied moment) :	0.0749 in ² /ft	
(4/3) * As :	0.0999 in ² /ft	Min Stem T&S Reinf Area 0.960 in ²
200bd/fy : 200(12)(6.1875)/60000 :	0.2475 in ² /ft	Min Stem T&S Reinf Area per ft of stem Height : 0.192 in ² /ft
0.0018bh : 0.0018(12)(8) :	0.1728 in ² /ft	Horizontal Reinforcing Options :
	=====	One layer of : Two layers of :
Required Area :	0.1728 in ² /ft	#4@ 12.50 in #4@ 25.00 in
Provided Area :	0.31 in ² /ft	#5@ 19.38 in #5@ 38.75 in
Maximum Area :	1.0059 in ² /ft	#6@ 27.50 in #6@ 55.00 in

Footing Data

Toe Width	=	1.50 ft
Heel Width	=	2.00
Total Footing Width	=	3.50
Footing Thickness	=	12.00 in
Key Width	=	10.00 in
Key Depth	=	18.00 in
Key Distance from Toe	=	0.00 ft
f'c =	3,000 psi	Fy = 60,000 psi
Footing Concrete Density	=	150.00 pcf
Min. As %	=	0.0018
Cover @ Top	2.00	@ Btm.= 3.00 in

Footing Design Results

	Toe	Heel
Factored Pressure	= 1,868	0 psf
Mu' : Upward	= 21,184	88 ft-#
Mu' : Downward	= 2,835	1,020 ft-#
Mu: Design	= 702	932 ft-#
Actual 1-Way Shear	= 11.03	11.01 psi
Allow 1-Way Shear	= 82.16	82.16 psi
Toe Reinforcing	= # 5 @ 12.00 in	
Heel Reinforcing	= # 4 @ 9.25 in	
Key Reinforcing	= # 4 @ 6.00 in	
Footing Torsion, Tu	=	0.00 ft-lbs
Footing Allow. Torsion, phi Tu	=	0.00 ft-lbs

If torsion exceeds allowable, provide supplemental design for footing torsion.

Other Acceptable Sizes & Spacings

Toe: #4@ 9.25 in, #5@ 14.34 in, #6@ 20.36 in, #7@ 27.77 in, #8@ 36.56 in, #9@ 46
Heel: #4@ 9.25 in, #5@ 14.34 in, #6@ 20.36 in, #7@ 27.77 in, #8@ 36.56 in, #9@ 46
Key: #4@ 11.1 in, #5@ 17.21 in, #6@ 18 in, #7@ 18 in, #8@ 18

Min footing T&S reinf Area	0.91 in ²
Min footing T&S reinf Area per foot	0.26 in ² /ft
If one layer of horizontal bars:	If two layers of horizontal bars:
#4@ 9.26 in	#4@ 18.52 in
#5@ 14.35 in	#5@ 28.70 in
#6@ 20.37 in	#6@ 40.74 in

Use menu item Settings > Printing & Title Block to set these five lines of information for your program.

Project Name/Number : 23-111-Site r
 Title 5'-0" CW W/Slab
 Dsgnr: GS
 Description....
 23-111

Page : 3
 Date: 28 MAR 2023

This Wall in File: C:\ZVELT-ONE DRIVE\ZVELT JOBS\2023\23-111 Mercer Island Phan-Nguyen Res M5762A3FU

RetainPro (c) 1987-2019, Build 11.19.11.12
 License : KW-06061901
 License To : Zvelt Engineering Design, PLLC

Cantilevered Retaining Wall

Code: IBC 2018,ACI 318-14,TMS 402-16

Summary of Overturning & Resisting Forces & Moments

ItemOVERTURNING.....		RESISTING.....			
	Force lbs	Distance ft	Moment ft-#	Force lbs	Distance ft	Moment ft-#	
HL Act Pres (ab water tbl)	529.4	1.83	970.5	Soil Over HL (ab. water tbl)	780.0	2.83	2,210.0
HL Act Pres (be water tbl)				Soil Over HL (bel. water tbl)		2.83	2,210.0
Hydrostatic Force				Watre Table			
Buoyant Force =				Sloped Soil Over Heel =			
Surcharge over Heel =	103.7	2.75	285.0	Surcharge Over Heel =			
Surcharge Over Toe =				Adjacent Footing Load =			
Adjacent Footing Load =				Axial Dead Load on Stem =			
Added Lateral Load =	306.0	3.25	994.5	* Axial Live Load on Stem =			
Load @ Stem Above Soil =				Soil Over Toe =			
=				Surcharge Over Toe =			
Seismic Stem Self Wt	17.5	3.50	61.3	Stem Weight(s) =	500.0	1.83	916.7
Total	= 956.5	O.T.M. =	2,311.3	Earth @ Stem Transitions =			
Resisting/Overturning Ratio	=	1.78		Footing Weight =	525.0	1.75	918.8
Vertical Loads used for Soil Pressure =		1,992.5 lbs		Key Weight =	187.5	0.42	78.1
				Vert. Component =			
				Total =	1,992.5 lbs	R.M.=	4,123.5

* Axial live load NOT included in total displayed, or used for overturning resistance, but is included for soil pressure calculation.

If seismic is included, the OTM and sliding ratios may be 1.1 per section 1807.2.3 of IBC.

Vertical component of active lateral soil pressure IS NOT considered in the calculation of Sliding Resistance.

Vertical component of active lateral soil pressure IS NOT considered in the calculation of Overturning Resistance.

Tilt

Horizontal Deflection at Top of Wall due to settlement of soil

(Deflection due to wall bending not considered)

Soil Spring Reaction Modulus 250.0 pci
 Horizontal Defl @ Top of Wall (approximate only) 0.051 in

Use menu item **Settings > Printing & Title Block** to set these five lines of information for your program.

Project Name/Number : 23-111-Site r

Title 7'-0" CW W/Slab

Dsgnr: GS

Description....

23-111

Page : 1

Date: 28 MAR 2023

This Wall in File: C:\ZVELT-ONE DRIVE\ZVELT JOBS\2023\23-111 Mercer Island Phan-Nguyen Res M5762A3FU

RetainPro (c) 1987-2019, Build 11.19.11.12

License : KW-06061901

License To : Zvelt Engineering Design, PLLC

Cantilevered Retaining Wall

Code: IBC 2018, ACI 318-14, TMS 402-16

Criteria

Retained Height	=	6.50 ft
Wall height above soil	=	0.50 ft
Slope Behind Wall	=	0.00
Height of Soil over Toe	=	0.00 in
Water height over heel	=	0.0 ft

Soil Data

Allow Soil Bearing	=	1,500.0 psf
Equivalent Fluid Pressure Method		
Active Heel Pressure	=	35.0 psf/ft
	=	
Passive Pressure	=	350.0 psf/ft
Soil Density, Heel	=	130.00 pcf
Soil Density, Toe	=	0.00 pcf
Footings Soil Friction	=	0.350
Soil height to ignore for passive pressure	=	0.00 in

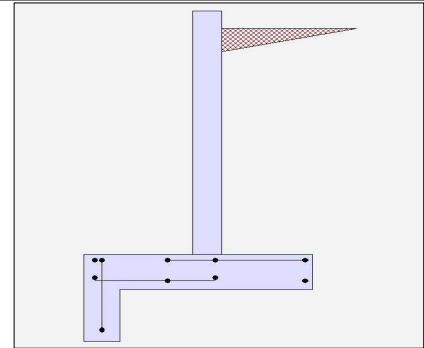

Surcharge Loads

Surcharge Over Heel	=	70.0 psf
NOT Used To Resist Sliding & Overturning		
Surcharge Over Toe	=	0.0
NOT Used for Sliding & Overturning		

Lateral Load Applied to Stem

Lateral Load	=	52.0 #/ft
...Height to Top	=	6.50 ft
...Height to Bottom	=	0.00 ft
Load Type	=	Seismic (E) (Service Level)
Wind on Exposed Stem	=	0.0 psf (Service Level)

Adjacent Footing Load

Adjacent Footing Load	=	0.0 lbs
Footing Width	=	0.00 ft
Eccentricity	=	0.00 in
Wall to Ftg CL Dist	=	0.00 ft
Footing Type		Line Load
Base Above/Below Soil at Back of Wall	=	0.0 ft
Poisson's Ratio	=	0.300

Axial Load Applied to Stem

Axial Dead Load	=	0.0 lbs
Axial Live Load	=	0.0 lbs
Axial Load Eccentricity	=	0.0 in

F_p / W_p Weight Multiplier	=	0.050 g	Added seismic base force	24.5 lbs
-------------------------------	---	---------	--------------------------	----------

Stem Weight Seismic Load

Design Summary

Wall Stability Ratios

Overturning	=	2.54 OK
Sliding	=	1.54 OK

Total Bearing Load	=	3,435 lbs
...resultant ecc.	=	4.91 in

Soil Pressure @ Toe	=	960 psf OK
Soil Pressure @ Heel	=	349 psf OK
Allowable	=	1,500 psf
Soil Pressure Less Than Allowable		

ACI Factored @ Toe	=	1,401 psf
ACI Factored @ Heel	=	509 psf

Footing Shear @ Toe	=	18.3 psi OK
Footing Shear @ Heel	=	15.1 psi OK
Allowable	=	82.2 psi

Sliding Calcs

Lateral Sliding Force	=	1,488.2 lbs
less 100% Passive Force	= -	1,093.8 lbs
less 100% Friction Force	= -	1,202.4 lbs

Added Force Req'd	=	0.0 lbs OK
....for 1.5 Stability	=	0.0 lbs OK

Vertical component of active lateral soil pressure IS NOT considered in the calculation of soil bearing

Load Factors

Building Code	IBC 2018, ACI
Dead Load	1.400
Live Load	1.700
Earth, H	1.700
Wind, W	1.300
Seismic, E	1.000

Stem Construction

Design Height Above Ftg	ft =	0.00
Wall Material Above "Ht"	=	Concrete
Design Method	=	LRFD
Thickness	=	8.00
Rebar Size	=	# 5
Rebar Spacing	=	12.00
Rebar Placed at	=	Edge

Design Data

fb/FB + fa/Fa	=	0.562
---------------	---	-------

Total Force @ Section

Service Level	lbs =	
Strength Level	lbs =	1,838.2

Moment....Actual

Service Level	ft-# =	
Strength Level	ft-# =	4,621.2
Moment....Allowable	=	8,206.3

Shear.....Actual

Service Level	psi =	
Strength Level	psi =	24.8
Shear.....Allowable	psi =	82.2

Masonry Data

Anet (Masonry)	in ² =	
Rebar Depth 'd'	in =	6.19

Masonry Data

f'm	psi =	
Fs	psi =	
Solid Grouting	=	
Modular Ratio 'n'	=	
Wall Weight	psf =	100.0
Short Term Factor	=	
Equiv. Solid Thick.	=	
Masonry Block Type	=	Medium Weight
Masonry Design Method	=	ASD

Concrete Data

f'c	psi =	3,000.0
Fy	psi =	60,000.0

Use menu item Settings > Printing & Title Block
to set these five lines of information
for your program.

Project Name/Number : 23-111-Site r
Title 7'-0" CW W/Slab
Dsgnr: GS
Description....
23-111

Page : 2
Date: 28 MAR 2023

This Wall in File: C:\ZVELT-ONE DRIVE\ZVELT JOBS\2023\23-111 Mercer Island Phan-Nguyen Res M5762A3FU

RetainPro (c) 1987-2019, Build 11.19.11.12
License : KW-06061901
License To : Zvelt Engineering Design, PLLC

Cantilevered Retaining Wall

Code: IBC 2018, ACI 318-14, TMS 402-16

Concrete Stem Rebar Area Details

Bottom Stem	Vertical Reinforcing	Horizontal Reinforcing
As (based on applied moment) :	0.175 in ² /ft	
(4/3) * As :	0.2333 in ² /ft	Min Stem T&S Reinf Area 1.344 in ²
200bd/fy : 200(12)(6.1875)/60000 :	0.2475 in ² /ft	Min Stem T&S Reinf Area per ft of stem Height : 0.192 in ² /ft
0.0018bh : 0.0018(12)(8) :	0.1728 in ² /ft	Horizontal Reinforcing Options :
	=====	One layer of : Two layers of :
Required Area :	0.2333 in ² /ft	#4@ 12.50 in #4@ 25.00 in
Provided Area :	0.31 in ² /ft	#5@ 19.38 in #5@ 38.75 in
Maximum Area :	1.0059 in ² /ft	#6@ 27.50 in #6@ 55.00 in

Footing Data

Toe Width	=	2.50 ft
Heel Width	=	2.75
Total Footing Width	=	5.25
Footing Thickness	=	12.00 in
Key Width	=	10.00 in
Key Depth	=	18.00 in
Key Distance from Toe	=	0.00 ft
f'c =	3,000 psi	Fy = 60,000 psi
Footing Concrete Density	=	150.00 pcf
Min. As %	=	0.0018
Cover @ Top	2.00	@ Btm.= 3.00 in

Footing Design Results

	Toe	Heel
Factored Pressure	= 1,401	509 psf
Mu' : Upward	= 47,237	1,360 ft-#
Mu' : Downward	= 7,875	3,281 ft-#
Mu: Design	= 2,328	1,921 ft-#
Actual 1-Way Shear	= 18.25	15.10 psi
Allow 1-Way Shear	= 82.16	82.16 psi
Toe Reinforcing	= # 5 @ 12.00 in	
Heel Reinforcing	= # 4 @ 9.25 in	
Key Reinforcing	= # 4 @ 6.00 in	
Footing Torsion, Tu	=	0.00 ft-lbs
Footing Allow. Torsion, phi Tu	=	0.00 ft-lbs

If torsion exceeds allowable, provide supplemental design for footing torsion.

Other Acceptable Sizes & Spacings

Toe: #4@ 9.25 in, #5@ 14.34 in, #6@ 20.36 in, #7@ 27.77 in, #8@ 36.56 in, #9@ 46
Heel: #4@ 9.25 in, #5@ 14.34 in, #6@ 20.36 in, #7@ 27.77 in, #8@ 36.56 in, #9@ 46
Key: #4@ 11.1 in, #5@ 17.21 in, #6@ 18 in, #7@ 18 in, #8@ 18

Min footing T&S reinf Area 1.36 in²
Min footing T&S reinf Area per foot 0.26 in²/ft

If one layer of horizontal bars: If two layers of horizontal bars:

#4@ 9.26 in	#4@ 18.52 in
#5@ 14.35 in	#5@ 28.70 in
#6@ 20.37 in	#6@ 40.74 in

Use menu item **Settings > Printing & Title Block** to set these five lines of information for your program.

Project Name/Number : 23-111-Site r
 Title 7'-0" CW W/Slab
 Dsgnr: GS
 Description....
 23-111

Page : 3
 Date: 28 MAR 2023

This Wall in File: C:\ZVELT-ONE DRIVE\ZVELT JOBS\2023\23-111 Mercer Island Phan-Nguyen Res M5762A3FU

RetainPro (c) 1987-2019, Build 11.19.11.12
 License : KW-06061901
 License To : Zvelt Engineering Design, PLLC

Cantilevered Retaining Wall

Code: IBC 2018,ACI 318-14,TMS 402-16

Summary of Overturning & Resisting Forces & Moments

ItemOVERTURNING.....		RESISTING.....			
	Force lbs	Distance ft	Moment ft-#	Force lbs	Distance ft	Moment ft-#	
HL Act Pres (ab water tbl)	984.4	2.50	2,460.9	Soil Over HL (ab. water tbl)	1,760.4	4.21	7,408.4
HL Act Pres (be water tbl)				Soil Over HL (bel. water tbl)		4.21	7,408.4
Hydrostatic Force				Watre Table			
Buoyant Force =				Sloped Soil Over Heel =			
Surcharge over Heel =	141.3	3.75	530.0	Surcharge Over Heel =			
Surcharge Over Toe =				Adjacent Footing Load =			
Adjacent Footing Load =				Axial Dead Load on Stem =			
Added Lateral Load =	338.0	4.25	1,436.5	* Axial Live Load on Stem =			
Load @ Stem Above Soil =				Soil Over Toe =			
				Surcharge Over Toe =			
Seismic Stem Self Wt	24.5	4.50	110.3	Stem Weight(s) =	700.0	2.83	1,983.3
Total	= 1,488.2	O.T.M. =	4,537.7	Earth @ Stem Transitions =			
Resisting/Overturning Ratio	=	2.54		Footing Weight =	787.5	2.63	2,067.2
Vertical Loads used for Soil Pressure =		3,435.4 lbs		Key Weight =	187.5	0.42	78.1
				Vert. Component =			
				Total =	3,435.4 lbs	R.M.=	11,537.1

* Axial live load NOT included in total displayed, or used for overturning resistance, but is included for soil pressure calculation.

If seismic is included, the OTM and sliding ratios may be 1.1 per section 1807.2.3 of IBC.

Vertical component of active lateral soil pressure IS NOT considered in the calculation of Sliding Resistance.

Vertical component of active lateral soil pressure IS NOT considered in the calculation of Overturning Resistance.

Tilt

Horizontal Deflection at Top of Wall due to settlement of soil

(Deflection due to wall bending not considered)

Soil Spring Reaction Modulus 250.0 pci
 Horizontal Defl @ Top of Wall (approximate only) 0.036 in

BEAM CALCULATIONS FOR

PLAN M5762A3FU-OFB

TO BE BUILT IN MERCER ISLAND, WA

FOR

PHAN-NGUYEN RESIDENCE

LOADING

Roof	15 PSF Dead Load + 25 PSF Live Load	=	40 PSF
Floor	15 PSF Dead Load + 40 PSF Live Load	=	55 PSF
Ceiling	5 PSF Dead Load + 10 PSF Live Load	=	15 PSF
Deck	10 PSF Dead Load + 60 PSF Live Load	=	70 PSF
Interior wall		=	07 PSF
Exterior wall		=	10 PSF

DEFLECTION

Roof	=	1 / 360 Live Load, 1 / 240 Total Load
Floor	=	1 / 480 Live Load, 1 / 360 Total Load

NOTE: This stamp applies to the members and assemblies described in these calculations only. And is valid if it has a wet stamp.



Architects Northwest JOB No. 220185

ARCHITECTS NORTHWEST, Inc.
18915 142nd Avenue NE Suite 100
Woodinville, WA 98072
(425) 485-4900 FAX (425) 487-6585
www.ArchitectsNW.com

DATE:	3/24/2023	COMPANY:	
STRUCALC BUILD:	StruCalc Plus	DESIGNED BY:	Sarah Weight
CUSTOMER:	Phan-Nguyen	REVIEWED BY:	Sarah Weight
PROJ. ADDRESS:	, Mercer Island, WA		

PROJECT SUMMARY

Project Name: Phan-Nguyen

Governing Codes:

Building Code: 2018 International Building Code

ASCE: ASCE 7-16

Steel: AISC 360-16

Concrete: ACI 318-14

Masonry: TMS 402/602-16

Module Location: GT1 - HIP MASTER @ BR3 & 4 (end reactions only)

Module Level: StruCalc Members

Module Type: Floor Beam

Material Type: Solid Sawn Douglas Fir-Larch No. 2

Member Dimensions: (1) 1.5 in. X 3.5 in. X 24 ft

Section Adequacy: 13.14%

Controlling Factor: Deflection

Module Location: GT2 - HIP MASTER @ BR2 (end reactions only)

Module Level: StruCalc Members

Module Type: Floor Beam

Material Type: Solid Sawn Douglas Fir-Larch No. 2

Member Dimensions: (1) 1.5 in. X 3.5 in. X 21.5 ft

Section Adequacy: 37.55%

Controlling Factor: Deflection

Module Location: GT3 - GIRDER TRUSS @ BA3 & WIC (end only) reactions

Module Level: StruCalc Members

Module Type: Roof Beam

Material Type: Solid Sawn Douglas Fir-Larch No. 2

Member Dimensions: (1) 1.5 in. X 3.5 in. X 15.3 ft

Section Adequacy: -98.44%

Controlling Factor: Deflection

Module Location: GT4 - HIP MASTER @ BR5 (end reactions only)

Module Level: StruCalc Members

Module Type: Roof Beam

Material Type: Solid Sawn Douglas Fir-Larch No. 2

Member Dimensions: (1) 1.5 in. X 3.5 in. X 15.5 ft

Section Adequacy: -98.04%

Controlling Factor: Deflection

Module Location: GT5 - GIRDER TRUSS @ BR5 (end reactions only)

Module Level: StruCalc Members

Module Type: Floor Beam

Material Type: Solid Sawn Douglas Fir-Larch No. 2

Member Dimensions: (1) 1.5 in. X 3.5 in. X 25.3 ft

Section Adequacy: -98.19%

Controlling Factor: Deflection

Module Location: GT6 - GIRDER TRUSS @ BR2 (end reactions only)

Module Level: StruCalc Members

Module Type: Floor Beam

Material Type: Solid Sawn Douglas Fir-Larch No. 2

Member Dimensions: (1) 1.5 in. X 3.5 in. X 21.5 ft

Section Adequacy:

Module Location: GT7 - GIRDER TRUSS @ BR3 & BR4 (end only) reactions

Module Level: StruCalc Members

Module Type: Floor Beam

Material Type: Solid Sawn Douglas Fir-Larch No. 2

Member Dimensions: (1) 1.5 in. X 3.5 in. X 24 ft

Section Adequacy: **-99.05%**

Controlling Factor: Deflection

Module Location: GT8 - GIRDER TRUSS @ GREAT RM (end only) reactions

Module Level: StruCalc Members

Module Type: Floor Beam

Material Type: Solid Sawn Douglas Fir-Larch No. 2

Member Dimensions: (1) 1.5 in. X 3.5 in. X 34 ft

Section Adequacy: **-97.66%**

Controlling Factor: Deflection

Module Location: GT9 - HIP MASTER @ STAIRS (end reactions only)

Module Level: StruCalc Members

Module Type: Floor Beam

Material Type: Solid Sawn Douglas Fir-Larch No. 2

Member Dimensions: (1) 1.5 in. X 3.5 in. X 11 ft

Section Adequacy: **91.64%**

Controlling Factor: Deflection

Module Location: GT10 - GIRDER TRUSS @ STAIR (end reactions only)

Module Level: StruCalc Members

Module Type: Roof Beam

Material Type: Solid Sawn Douglas Fir-Larch No. 2

Member Dimensions: (1) 1.5 in. X 3.5 in. X 11 ft

Section Adequacy: **-97.39%**

Controlling Factor: Deflection

Module Location: GT11 - GIRDER TRUSS @ GREAT RM (end only) reactions

Module Level: StruCalc Members

Module Type: Floor Beam

Material Type: Solid Sawn Douglas Fir-Larch No. 2

Member Dimensions: (1) 1.5 in. X 3.5 in. X 34 ft

Section Adequacy: **-99.51%**

Controlling Factor: Deflection

Module Location: GT12 - GIRDER TRUSS @ MBR & STAIR (end reactions only)

Module Level: StruCalc Members

Module Type: Floor Beam

Material Type: Solid Sawn Douglas Fir-Larch No. 2

Member Dimensions: (1) 1.5 in. X 3.5 in. X 34 ft

Section Adequacy: **-99.51%**

Controlling Factor: Deflection

Module Location: GT13 - HIP MASTER @ MBA @ LDY (end only) reactions

Module Level: StruCalc Members

Module Type: Floor Beam

Material Type: Solid Sawn Douglas Fir-Larch No. 2

Member Dimensions: (1) 1.5 in. X 3.5 in. X 34 ft

Section Adequacy: **-59.51%**

Controlling Factor: Deflection

Module Location: GT14 - GIRDER TRUSS at MBR (end reactions only)

Module Level: StruCalc Members

Module Type: Floor Beam

Material Type: Solid Sawn Douglas Fir-Larch No. 2
Member Dimensions: (1) 1.5 in. X 3.5 in. X 18 ft
Section Adequacy: **-95.24%**
Controlling Factor: Deflection

Module Location: GT15 - HIP MASTER @ MBR (end reactions only)

Module Level: StruCalc Members
Module Type: Floor Beam
Material Type: Solid Sawn Douglas Fir-Larch No. 2
Member Dimensions: (1) 1.5 in. X 3.5 in. X 18 ft
Section Adequacy: **63.35%**
Controlling Factor: Deflection

Module Location: R01 - BR3 WDO HDR

Module Level: StruCalc Members
Module Type: Floor Beam
Material Type: Solid Sawn Douglas Fir-Larch No. 2
Member Dimensions: (1) 5.5 in. X 11.5 in. X 8.7 ft
Section Adequacy: **98.03%**
Controlling Factor: Bending Stress Y

Module Location: R02 - BR2 WDO HDR

Module Level: StruCalc Members
Module Type: Floor Beam
Material Type: Glulams Stress Class Rated 24F-1.8E 24F-V4 DF/DF
Member Dimensions: (1) 5.125 in. X 12 in. X 17 ft
Section Adequacy: **97.67%**
Controlling Factor: Deflection

Module Location: R03 - COV'D DECK BEAM

Module Level: StruCalc Members
Module Type: Floor Beam
Material Type: Glulams Stress Class Rated 24F-1.8E 24F-V4 DF/DF
Member Dimensions: (1) 5.125 in. X 12 in. X 18 ft
Section Adequacy: **97.23%**
Controlling Factor: Deflection

Module Location: R04 - GREAT ROOM WDO HDR

Module Level: StruCalc Members
Module Type: Roof Beam
Material Type: Solid Sawn Douglas Fir-Larch No. 2
Member Dimensions: (1) 3.5 in. X 11.25 in. X 7.5 ft
Section Adequacy: **28.67%**
Controlling Factor: Bending Stress Y

Module Location: R05 - GREAT ROOM WDO HDR SIDES

Module Level: StruCalc Members
Module Type: Roof Beam
Material Type: Solid Sawn Douglas Fir-Larch No. 2
Member Dimensions: (1) 3.5 in. X 11.25 in. X 4.1 ft
Section Adequacy: **71.57%**
Controlling Factor: Shear Stress Y

Module Location: R06 - COV'D PATIO BEAM

Module Level: StruCalc Members
Module Type: Roof Beam
Material Type: Solid Sawn Douglas Fir-Larch No. 2
Member Dimensions: (1) 3.5 in. X 11.25 in. X 16 ft
Section Adequacy: **28.67%**
Controlling Factor: Bending Stress Y

Module Location: R07 - BR4 WDO HDR

Module Level: StruCalc Members
Module Type: Floor Beam
Material Type: Solid Sawn Douglas Fir-Larch No. 2
Member Dimensions: (1) 3.5 in. X 9.25 in. X 6.8 ft
Section Adequacy: **98.6%**
Controlling Factor: Bending Stress Y

Module Location: U01 - BR6 WDO HDR

Module Level: StruCalc Members

Module Type: Floor Beam

Material Type: Solid Sawn Douglas Fir-Larch No. 2

Member Dimensions: (1) 5.5 in. X 11.5 in. X 8.7 ft

Section Adequacy: 29.85%

Controlling Factor: Bending Stress Y

Module Location: U02 - LIV/DIN WDO HDR

Module Level: StruCalc Members

Module Type: Floor Beam

Material Type: Glulams Stress Class Rated 24F-1.8E 24F-V4 DF/DF

Member Dimensions: (1) 5.125 in. X 12 in. X 13 ft

Section Adequacy: 17.78%

Controlling Factor: Deflection

Module Location: U02.OT1 - LIV/DIN WDO HDR

Module Level: StruCalc Members

Module Type: Floor Beam

Material Type: Glulams Stress Class Rated 24F-1.8E 24F-V4 DF/DF

Member Dimensions: (1) 5.125 in. X 12 in. X 13 ft

Section Adequacy: 33.54%

Controlling Factor: Bearing Stress

Module Location: U02.OT2 - LIV/DIN WDO HDR

Module Level: StruCalc Members

Module Type: Floor Beam

Material Type: Glulams Stress Class Rated 24F-1.8E 24F-V4 DF/DF

Member Dimensions: (1) 5.125 in. X 12 in. X 13 ft

Section Adequacy: 33.54%

Controlling Factor: Bearing Stress

Module Location: U03 - BRIDGE BEAM

Module Level: StruCalc Members

Module Type: Floor Beam

Material Type: Glulams Stress Class Rated 24F-1.8E 24F-V4 DF/DF

Member Dimensions: (1) 3.125 in. X 18 in. X 23.9 ft

Section Adequacy: 37.36%

Controlling Factor: Deflection

Module Location: U04 - BRIDGE BEAM

Module Level: StruCalc Members

Module Type: Floor Beam

Material Type: Glulams Stress Class Rated 24F-1.8E 24F-V4 DF/DF

Member Dimensions: (1) 3.125 in. X 16.5 in. X 20.6 ft

Section Adequacy: 96.7%

Controlling Factor: Deflection

Module Location: U05 - DINING BEAM

Module Level: StruCalc Members

Module Type: Floor Beam

Material Type: Glulams Stress Class Rated 24F-1.8E 24F-V4 DF/DF

Member Dimensions: (1) 5.125 in. X 18 in. X 18 ft

Section Adequacy: 27.42%

Controlling Factor: Bearing Stress

Module Location: U06 - DINING WDO HDR

Module Level: StruCalc Members

Module Type: Floor Beam

Material Type: Glulams Stress Class Rated 24F-1.8E 24F-V4 DF/DF

Member Dimensions: (1) 5.125 in. X 16.5 in. X 10 ft

Section Adequacy: 51.18%

Controlling Factor: Bearing Stress

Module Location: U06.OT1 - DINING WDO HDR

Module Level: StruCalc Members

Module Type: Floor Beam

Material Type: Glulams Stress Class Rated 24F-1.8E 24F-V4 DF/DF

Member Dimensions: (1) 5.125 in. X 16.5 in. X 10 ft

Section Adequacy: 99.04%

Controlling Factor: Bearing Stress

Module Location: U06.OT2 - DINING WDO HDR

Module Level: StruCalc Members

Module Type: Floor Beam

Material Type: Glulams Stress Class Rated 24F-1.8E 24F-V4 DF/DF

Member Dimensions: (1) 5.125 in. X 16.5 in. X 10 ft

Section Adequacy: 99.04%

Controlling Factor: Bearing Stress

Module Location: U07 - DINING SGD HDR

Module Level: StruCalc Members

Module Type: Floor Beam

Material Type: Solid Sawn Douglas Fir-Larch No. 2

Member Dimensions: (1) 5.5 in. X 11.5 in. X 12.3 ft

Section Adequacy: 15.06%

Controlling Factor: Bending Stress Y

Module Location: U08 - COV'D PATIO BEAM

Module Level: StruCalc Members

Module Type: Floor Beam

Material Type: Glulams Stress Class Rated 24F-1.8E 24F-V4 DF/DF

Member Dimensions: (1) 5.125 in. X 13.5 in. X 17.4 ft

Section Adequacy: 17.04%

Controlling Factor: Deflection

Module Location: U09 - COV'D DECK BEAM

Module Level: StruCalc Members

Module Type: Floor Beam

Material Type: Glulams Stress Class Rated 24F-1.8E 24F-V4 DF/DF

Member Dimensions: (1) 5.125 in. X 15 in. X 18 ft

Section Adequacy: 40.67%

Controlling Factor: Deflection

Module Location: U10 - COV'D PATIO SIDE BEAM

Module Level: StruCalc Members

Module Type: Floor Beam

Material Type: Glulams Stress Class Rated 24F-1.8E 24F-V4 DF/DF

Member Dimensions: (1) 5.125 in. X 13.5 in. X 12.5 ft

Section Adequacy: 60.2%

Controlling Factor: Bending Stress Y

Module Location: U10.OT1 - COV'D PATIO SIDE BEAM

Module Level: StruCalc Members

Module Type: Floor Beam

Material Type: Glulams Stress Class Rated 24F-1.8E 24F-V4 DF/DF

Member Dimensions: (1) 5.125 in. X 13.5 in. X 12.5 ft

Section Adequacy: 98.89%

Controlling Factor: Bending Stress Y

Module Location: U10.OT2 - COV'D PATIO SIDE BEAM

Module Level: StruCalc Members

Module Type: Floor Beam

Material Type: Glulams Stress Class Rated 24F-1.8E 24F-V4 DF/DF

Member Dimensions: (1) 5.125 in. X 13.5 in. X 12.5 ft

Section Adequacy: 98.89%

Controlling Factor: Bending Stress Y

Module Location: U11 - COV'D PATIO SIDE BEAM

Module Level: StruCalc Members

Module Type: Floor Beam

Material Type: Glulams Stress Class Rated 24F-1.8E 24F-V4 DF/DF

Member Dimensions: (1) 5.125 in. X 13.5 in. X 12.5 ft

Section Adequacy: 60.2%

Controlling Factor: Bending Stress Y

Module Location: U11.OT1 - COV'D PATIO SIDE BEAM

Module Level: StruCalc Members
Module Type: Floor Beam
Material Type: Glulams Stress Class Rated 24F-1.8E 24F-V4 DF/DF
Member Dimensions: (1) 5.125 in. X 13.5 in. X 12.5 ft
Section Adequacy: 98.89%
Controlling Factor: Bending Stress Y

Module Location: U11.OT2 - COV'D PATIO SIDE BEAM

Module Level: StruCalc Members
Module Type: Floor Beam
Material Type: Glulams Stress Class Rated 24F-1.8E 24F-V4 DF/DF
Member Dimensions: (1) 5.125 in. X 13.5 in. X 12.5 ft
Section Adequacy: 98.89%
Controlling Factor: Bending Stress Y

Module Location: U12 - DEN/PLAY WDO HDR

Module Level: StruCalc Members
Module Type: Floor Beam
Material Type: Solid Sawn Douglas Fir-Larch No. 2
Member Dimensions: (1) 5.5 in. X 11.5 in. X 9 ft
Section Adequacy: 19.02%
Controlling Factor: Bending Stress Y

Module Location: U13 - COV'D PATIO SIDE BEAMS

Module Level: StruCalc Members
Module Type: Floor Beam
Material Type: Solid Sawn Douglas Fir-Larch No. 2
Member Dimensions: (1) 3.5 in. X 11.25 in. X 6.5 ft
Section Adequacy: 99.13%
Controlling Factor: Bending Stress Y

Module Location: U13.OT1 - COV'D PATIO SIDE BEAMS

Module Level: StruCalc Members
Module Type: Floor Beam
Material Type: Solid Sawn Douglas Fir-Larch No. 2
Member Dimensions: (1) 3.5 in. X 11.25 in. X 6.5 ft
Section Adequacy: 99.13%
Controlling Factor: Bending Stress Y

Module Location: U13.OT2 - COV'D PATIO SIDE BEAMS

Module Level: StruCalc Members
Module Type: Floor Beam
Material Type: Solid Sawn Douglas Fir-Larch No. 2
Member Dimensions: (1) 3.5 in. X 11.25 in. X 6.5 ft
Section Adequacy: 99.13%
Controlling Factor: Bending Stress Y

Module Location: U14 - COV'D ENTRY BEAM

Module Level: StruCalc Members
Module Type: Floor Beam
Material Type: Glulams Stress Class Rated 24F-1.8E 24F-V4 DF/DF
Member Dimensions: (1) 5.125 in. X 15 in. X 14.5 ft
Section Adequacy: 91.32%
Controlling Factor: Bearing Stress

Module Location: M01 - GARAGE OHD HDR

Module Level: StruCalc Members
Module Type: Floor Beam
Material Type: Solid Sawn Douglas Fir-Larch No. 2
Member Dimensions: (1) 5.5 in. X 11.5 in. X 9 ft
Section Adequacy: 26.82%
Controlling Factor: Bending Stress Y

Module Location: M02 - GARAGE BEAM

Module Level: StruCalc Members
Module Type: Floor Beam
Material Type: Glulams Stress Class Rated 24F-1.8E 24F-V4 DF/DF
Member Dimensions: (1) 3.125 in. X 12 in. X 10.7 ft
Section Adequacy:

Module Location: M03 - GARAGE BEAM

Module Level: StruCalc Members

Module Type: Floor Beam

Material Type: Glulams Stress Class Rated 24F-1.8E 24F-V4 DF/DF

Member Dimensions: (1) 5.5 in. X 22.5 in. X 22 ft

Section Adequacy: 22.78%

Controlling Factor: Bearing Stress

Module Location: M04 - GARAGE OHD HDR

Module Level: StruCalc Members

Module Type: Floor Beam

Material Type: Glulams Stress Class Rated 24F-1.8E 24F-V4 DF/DF

Member Dimensions: (1) 6.75 in. X 15 in. X 16.7 ft

Section Adequacy: 62.36%

Controlling Factor: Bearing Stress

Module Location: M05 - BR7 WDO HDR

Module Level: StruCalc Members

Module Type: Floor Beam

Material Type: Glulams Stress Class Rated 24F-1.8E 24F-V4 DF/DF

Member Dimensions: (1) 5.125 in. X 10.5 in. X 6.7 ft

Section Adequacy: 99.31%

Controlling Factor: Shear Stress Y

Module Location: M05.OT1 - BR7 WDO HDR

Module Level: StruCalc Members

Module Type: Floor Beam

Material Type: Glulams Stress Class Rated 24F-1.8E 24F-V4 DF/DF

Member Dimensions: (1) 5.125 in. X 10.5 in. X 6.7 ft

Section Adequacy: 99.52%

Controlling Factor: Shear Stress Y

Module Location: M05.OT2 - BR7 WDO HDR

Module Level: StruCalc Members

Module Type: Floor Beam

Material Type: Glulams Stress Class Rated 24F-1.8E 24F-V4 DF/DF

Member Dimensions: (1) 5.125 in. X 10.5 in. X 6.7 ft

Section Adequacy: 99.52%

Controlling Factor: Shear Stress Y

Module Location: M06 - BR7 BEAM

Module Level: StruCalc Members

Module Type: Floor Beam

Material Type: Glulams Stress Class Rated 24F-1.8E 24F-V4 DF/DF

Member Dimensions: (1) 3.125 in. X 16.5 in. X 14.7 ft

Section Adequacy: 98.59%

Controlling Factor: Bearing Stress

Module Location: M07 - OFFICE 2 WDO HDR

Module Level: StruCalc Members

Module Type: Floor Beam

Material Type: Solid Sawn Douglas Fir-Larch No. 2

Member Dimensions: (1) 3.5 in. X 9.25 in. X 6.7 ft

Section Adequacy: 51.29%

Controlling Factor: Bending Stress Y

Module Location: M07.OT1 - OFFICE 2 WDO HDR

Module Level: StruCalc Members

Module Type: Floor Beam

Material Type: Solid Sawn Douglas Fir-Larch No. 2

Member Dimensions: (1) 3.5 in. X 9.25 in. X 6.7 ft

Section Adequacy: 20.05%

Controlling Factor: Bending Stress Y

Module Location: M07.OT2 - OFFICE 2 WDO HDR

Module Level: StruCalc Members

Module Type: Floor Beam

Material Type: Solid Sawn Douglas Fir-Larch No. 2
Member Dimensions: (1) 3.5 in. X 9.25 in. X 6.7 ft
Section Adequacy: 48.71%
Controlling Factor: Bending Stress Y

Module Location: M08 - OFFICE 1 WDO HDR
Module Level: StruCalc Members
Module Type: Floor Beam
Material Type: Solid Sawn Douglas Fir-Larch No. 2
Member Dimensions: (1) 5.5 in. X 11.5 in. X 6.7 ft
Section Adequacy: 45.49%
Controlling Factor: Bending Stress Y

Module Location: M09 - ENTRY DECK BEAM
Module Level: StruCalc Members
Module Type: Floor Beam
Material Type: Solid Sawn Douglas Fir-Larch No. 2
Member Dimensions: (1) 5.5 in. X 11.5 in. X 12 ft
Section Adequacy: 19.61%
Controlling Factor: Bending Stress Y

Module Location: C01 - COL at R01b
Module Level: StruCalc Members
Module Type: Column
Material Type: Solid Sawn Douglas Fir-Larch No. 2
Member Dimensions: (3) 1.5 in. X 5.5 in. X 9 ft
Section Adequacy: 99.03%
Controlling Factor: Compressive Stress

Module Location: C02 - COL at GT7a
Module Level: StruCalc Members
Module Type: Column
Material Type: Solid Sawn Douglas Fir-Larch No. 2
Member Dimensions: (3) 1.5 in. X 5.5 in. X 9 ft
Section Adequacy: 87.89%
Controlling Factor: Compressive Stress

Module Location: C03 - COL at GT8a
Module Level: StruCalc Members
Module Type: Column
Material Type: Solid Sawn Douglas Fir-Larch No. 2
Member Dimensions: (1) 5.5 in. X 5.5 in. X 9 ft
Section Adequacy: 97.24%
Controlling Factor: Compressive Stress

Module Location: C04 - COL at GT11a
Module Level: StruCalc Members
Module Type: Column
Material Type: Solid Sawn Douglas Fir-Larch No. 2
Member Dimensions: (3) 1.5 in. X 5.5 in. X 10 ft
Section Adequacy: 79.2%
Controlling Factor: Compressive Stress

Module Location: C05 - COL at GT12a
Module Level: StruCalc Members
Module Type: Column
Material Type: Solid Sawn Douglas Fir-Larch No. 2
Member Dimensions: (3) 1.5 in. X 5.5 in. X 9 ft
Section Adequacy: 82.7%
Controlling Factor: Compressive Stress

Module Location: C06 - COL at GT13a
Module Level: StruCalc Members
Module Type: Column
Material Type: Solid Sawn Douglas Fir-Larch No. 2
Member Dimensions: (3) 1.5 in. X 5.5 in. X 9 ft
Section Adequacy: 99.44%
Controlling Factor: Compressive Stress

Module Location: C07 - COL at GT14b & HDR

Module Level: StruCalc Members
Module Type: Column
Material Type: Solid Sawn Douglas Fir-Larch No. 2
Member Dimensions: (3) 1.5 in. X 5.5 in. X 9 ft
Section Adequacy: 83.99%
Controlling Factor: Compressive Stress

Module Location: C08 - COL at GT14a

Module Level: StruCalc Members
Module Type: Column
Material Type: Solid Sawn Douglas Fir-Larch No. 2
Member Dimensions: (3) 1.5 in. X 5.5 in. X 9 ft
Section Adequacy: 96.19%
Controlling Factor: Compressive Stress

Module Location: C09 - COL at R04a & R05b

Module Level: StruCalc Members
Module Type: Column
Material Type: Glulams Stress Class Rated 24F-1.8E 24F-V8 DF/DF
Member Dimensions: (1) 5.125 in. X 6 in. X 19.6 ft
Section Adequacy: 53.43%
Controlling Factor: Compressive Stress

Module Location: C10 - COL at R05a

Module Level: StruCalc Members
Module Type: Column
Material Type: Glulams Stress Class Rated 24F-1.8E 24F-V8 DF/DF
Member Dimensions: (1) 5.125 in. X 6 in. X 19.6 ft
Section Adequacy: 81.86%
Controlling Factor: Compressive Stress

Module Location: C11 - COL at GT5b

Module Level: StruCalc Members
Module Type: Column
Material Type: Solid Sawn Douglas Fir-Larch No. 2
Member Dimensions: (3) 1.5 in. X 5.5 in. X 9 ft
Section Adequacy: 91.08%
Controlling Factor: Compressive Stress

Module Location: C12 - COL at GT7b

Module Level: StruCalc Members
Module Type: Column
Material Type: Solid Sawn Douglas Fir-Larch No. 2
Member Dimensions: (3) 1.5 in. X 5.5 in. X 9 ft
Section Adequacy: 93.28%
Controlling Factor: Compressive Stress

Module Location: C13 - COL at R01a & U01a

Module Level: StruCalc Members
Module Type: Column
Material Type: Solid Sawn Douglas Fir-Larch No. 2
Member Dimensions: (3) 1.5 in. X 5.5 in. X 10 ft
Section Adequacy: 72.97%
Controlling Factor: Compressive Stress

Module Location: C14 - COL at R01b & U01b

Module Level: StruCalc Members
Module Type: Column
Material Type: Solid Sawn Douglas Fir-Larch No. 2
Member Dimensions: (3) 1.5 in. X 5.5 in. X 10 ft
Section Adequacy: 72.92%
Controlling Factor: Compressive Stress

Module Location: C15 - COL at U02ab

Module Level: StruCalc Members
Module Type: Column
Material Type: Solid Sawn Douglas Fir-Larch No. 2
Member Dimensions: (3) 1.5 in. X 5.5 in. X 10 ft
Section Adequacy:

Controlling Factor: Compressive Stress

Module Location: C16 - COL at U03ab

Module Level: StruCalc Members

Module Type: Column

Material Type: Solid Sawn Douglas Fir-Larch No. 2

Member Dimensions: (1) 3.5 in. X 3.5 in. X 10 ft

Section Adequacy: 51.8%

Controlling Factor: Compressive Stress

Module Location: C17 - COL at U04a

Module Level: StruCalc Members

Module Type: Column

Material Type: Solid Sawn Douglas Fir-Larch No. 2

Member Dimensions: (1) 3.5 in. X 3.5 in. X 10 ft

Section Adequacy: 96.78%

Controlling Factor: Compressive Stress

Module Location: C18 - COL at U04b

Module Level: StruCalc Members

Module Type: Column

Material Type: Solid Sawn Douglas Fir-Larch No. 2

Member Dimensions: (1) 3.5 in. X 3.5 in. X 10 ft

Section Adequacy: 96.78%

Controlling Factor: Compressive Stress

Module Location: C19 - COL at U06a

Module Level: StruCalc Members

Module Type: Column

Material Type: Solid Sawn Douglas Fir-Larch No. 2

Member Dimensions: (3) 1.5 in. X 5.5 in. X 10 ft

Section Adequacy: 54.85%

Controlling Factor: Compressive Stress

Module Location: C20 - COL at U06b

Module Level: StruCalc Members

Module Type: Column

Material Type: Solid Sawn Douglas Fir-Larch No. 2

Member Dimensions: (1) 5.5 in. X 5.5 in. X 10 ft

Section Adequacy: 72.77%

Controlling Factor: Compressive Stress

Module Location: C21 - COL at U10a

Module Level: StruCalc Members

Module Type: Column

Material Type: Solid Sawn Douglas Fir-Larch No. 2

Member Dimensions: (3) 1.5 in. X 5.5 in. X 10 ft

Section Adequacy: 74.27%

Controlling Factor: Compressive Stress

Module Location: C22 - COL at R03b, HDR, U10b & U09b

Module Level: StruCalc Members

Module Type: Column

Material Type: Solid Sawn Douglas Fir-Larch No. 2

Member Dimensions: (1) 5.5 in. X 5.5 in. X 10 ft

Section Adequacy: 59.57%

Controlling Factor: Compressive Stress

Module Location: C23 - COL at R03a, HDR, U09a, & U11b

Module Level: StruCalc Members

Module Type: Column

Material Type: Solid Sawn Douglas Fir-Larch No. 2

Member Dimensions: (1) 5.5 in. X 5.5 in. X 10 ft

Section Adequacy: 59.57%

Controlling Factor: Compressive Stress

Module Location: C24 - COL at U05a

Module Level: StruCalc Members

Module Type: Column

Material Type: Solid Sawn Douglas Fir-Larch No. 2
Member Dimensions: (3) 1.5 in. X 5.5 in. X 10 ft
Section Adequacy: 33.14%
Controlling Factor: Compressive Stress

Module Location: C25 - COL at U12ab

Module Level: StruCalc Members

Module Type: Column

Material Type: Solid Sawn Douglas Fir-Larch No. 2
Member Dimensions: (3) 1.5 in. X 5.5 in. X 10 ft
Section Adequacy: 70.58%
Controlling Factor: Compressive Stress

Module Location: C26 - COL at U14b & GT3b

Module Level: StruCalc Members

Module Type: Column

Material Type: Solid Sawn Douglas Fir-Larch No. 2
Member Dimensions: (1) 5.5 in. X 5.5 in. X 10 ft
Section Adequacy: 79.81%
Controlling Factor: Compressive Stress

Module Location: C27 - COL at U14a

Module Level: StruCalc Members

Module Type: Column

Material Type: Solid Sawn Douglas Fir-Larch No. 2
Member Dimensions: (3) 1.5 in. X 5.5 in. X 10 ft
Section Adequacy: 96.76%
Controlling Factor: Compressive Stress

Module Location: C28 - COL at R01a, U01a, & M01a

Module Level: StruCalc Members

Module Type: Column

Material Type: Solid Sawn Douglas Fir-Larch No. 2
Member Dimensions: (3) 1.5 in. X 5.5 in. X 9 ft
Section Adequacy: 55.21%
Controlling Factor: Compressive Stress

Module Location: C29 - COL at R01b, U01b, & M01b

Module Level: StruCalc Members

Module Type: Column

Material Type: Solid Sawn Douglas Fir-Larch No. 2
Member Dimensions: (3) 1.5 in. X 5.5 in. X 9 ft
Section Adequacy: 55.17%
Controlling Factor: Compressive Stress

Module Location: C30 - COL at R02ab, M04ab, & OT

Module Level: StruCalc Members

Module Type: Column

Material Type: Solid Sawn Douglas Fir-Larch No. 2
Member Dimensions: (1) 5.5 in. X 7.5 in. X 9 ft
Section Adequacy: 52.84%
Controlling Factor: Compressive Stress

Module Location: C31 - COL at M03a

Module Level: StruCalc Members

Module Type: Column

Material Type: Solid Sawn Douglas Fir-Larch No. 2
Member Dimensions: (1) 5.5 in. X 5.5 in. X 9 ft
Section Adequacy: 54.23%
Controlling Factor: Compressive Stress

Module Location: C32 - COL at M03b& U03a

Module Level: StruCalc Members

Module Type: Column

Material Type: Solid Sawn Douglas Fir-Larch No. 2
Member Dimensions: (1) 5.5 in. X 5.5 in. X 9 ft
Section Adequacy: 37.27%
Controlling Factor: Compressive Stress

Module Location: C33 - COL at M05.OT1a

Module Level: StruCalc Members
 Module Type: Column
 Material Type: Solid Sawn Douglas Fir-Larch No. 2
 Member Dimensions: (3) 1.5 in. X 5.5 in. X 9 ft
 Section Adequacy: 99.28%
 Controlling Factor: Compressive Stress

Module Location: C34 - COL at M05.OT1b

Module Level: StruCalc Members
 Module Type: Column
 Material Type: Solid Sawn Douglas Fir-Larch No. 2
 Member Dimensions: (3) 1.5 in. X 5.5 in. X 9 ft
 Section Adequacy: 99.28%
 Controlling Factor: Compressive Stress

Module Location: C35 - COL at M06a

Module Level: StruCalc Members
 Module Type: Column
 Material Type: Solid Sawn Douglas Fir-Larch No. 2
 Member Dimensions: (1) 3.5 in. X 5.5 in. X 9 ft
 Section Adequacy: 98.56%
 Controlling Factor: Compressive Stress

Module Location: C36 - COL at M06b

Module Level: StruCalc Members
 Module Type: Column
 Material Type: Solid Sawn Douglas Fir-Larch No. 2
 Member Dimensions: (3) 1.5 in. X 5.5 in. X 9 ft
 Section Adequacy: 98.92%
 Controlling Factor: Compressive Stress

Module Location: C37 - COL at M08ab

Module Level: StruCalc Members
 Module Type: Column
 Material Type: Solid Sawn Douglas Fir-Larch No. 2
 Member Dimensions: (3) 1.5 in. X 5.5 in. X 9 ft
 Section Adequacy: 78.46%
 Controlling Factor: Compressive Stress

Module Location: F01 - FTG at R01a, U01a, & M01a (C28)

Module Level: StruCalc Members
 Module Type: Isolated Footing
 Material Type: Concrete
 Member Dimensions: 2.5 ft. wide X 10 in. tall X 2.5 ft long
 Section Adequacy: 38.3%
 Controlling Factor: Soil Bearing Pressure
 Reinforcement Bars: Size #4, No. Bars Short (4), No. Bars Long: (3)

Module Location: F02 - FTG at R01b, U01b, & M01b (C29)

Module Level: StruCalc Members
 Module Type: Isolated Footing
 Material Type: Concrete
 Member Dimensions: 3 ft. wide X 10 in. tall X 3 ft long
 Section Adequacy: 57.11%
 Controlling Factor: Soil Bearing Pressure
 Reinforcement Bars: Size #4, No. Bars Short (4), No. Bars Long: (4)

Module Location: F03 - FTG at GT7a (C02)

Module Level: StruCalc Members
 Module Type: Isolated Footing
 Material Type: Concrete
 Member Dimensions: 2.5 ft. wide X 10 in. tall X 2.5 ft long
 Section Adequacy: 82.99%
 Controlling Factor: Soil Bearing Pressure
 Reinforcement Bars: Size #4, No. Bars Short (4), No. Bars Long: (3)

Module Location: F04 - FTG at R02ab, M04ab, & OT (C30)

Module Level: StruCalc Members
 Module Type: Isolated Footing

Material Type: Concrete
Member Dimensions: 4 ft. wide X 10 in. tall X 4 ft long
Section Adequacy: 55.04%
Controlling Factor: Soil Bearing Pressure
Reinforcement Bars: Size #4, No. Bars Short (5), No. Bars Long: (5)

Module Location: F05 - FTG at GT8a (C03)
Module Level: StruCalc Members
Module Type: Isolated Footing
Material Type: Concrete
Member Dimensions: 3 ft. wide X 10 in. tall X 3 ft long
Section Adequacy: 96.47%
Controlling Factor: Soil Bearing Pressure
Reinforcement Bars: Size #4, No. Bars Short (4), No. Bars Long: (4)

Module Location: F06 - FTG at M03a (C31)
Module Level: StruCalc Members
Module Type: Isolated Footing
Material Type: Concrete
Member Dimensions: 2.5 ft. wide X 10 in. tall X 2.5 ft long
Section Adequacy: 18.11%
Controlling Factor: Soil Bearing Pressure
Reinforcement Bars: Size #4, No. Bars Short (4), No. Bars Long: (3)

Module Location: F07 - FTG at U03a & M03 b (C32)
Module Level: StruCalc Members
Module Type: Isolated Footing
Material Type: Concrete
Member Dimensions: 3 ft. wide X 10 in. tall X 3 ft long
Section Adequacy: 21.89%
Controlling Factor: Soil Bearing Pressure
Reinforcement Bars: Size #4, No. Bars Short (4), No. Bars Long: (4)

Module Location: F08 - FTG at M06a (C35)
Module Level: StruCalc Members
Module Type: Isolated Footing
Material Type: Concrete
Member Dimensions: 2 ft. wide X 10 in. tall X 2 ft long
Section Adequacy: 98.56%
Controlling Factor: Soil Bearing Pressure
Reinforcement Bars: Size #4, No. Bars Short (3), No. Bars Long: (3)

Module Location: F09 - FTG at R03b, HDR, U10b, & U09b (C22)
Module Level: StruCalc Members
Module Type: Isolated Footing
Material Type: Concrete
Member Dimensions: 3 ft. wide X 10 in. tall X 3 ft long
Section Adequacy: 51.55%
Controlling Factor: Soil Bearing Pressure
Reinforcement Bars: Size #4, No. Bars Short (4), No. Bars Long: (4)

Module Location: F10 - FTG at R03a, HDR, U11b, & U09a (C22)
Module Level: StruCalc Members
Module Type: Isolated Footing
Material Type: Concrete
Member Dimensions: 3 ft. wide X 10 in. tall X 3 ft long
Section Adequacy: 51.4%
Controlling Factor: Soil Bearing Pressure
Reinforcement Bars: Size #4, No. Bars Short (4), No. Bars Long: (4)

Module Location: F11 - FTG at U14a (C27)
Module Level: StruCalc Members
Module Type: Isolated Footing
Material Type: Concrete
Member Dimensions: 3 ft. wide X 10 in. tall X 3 ft long
Section Adequacy: 97.7%
Controlling Factor: Soil Bearing Pressure
Reinforcement Bars: Size #4, No. Bars Short (4), No. Bars Long: (4)

PASS

DATE:	3/24/2023	COMPANY:	Architects Northwest
STRUCALC BUILD:	StruCalc Plus	DESIGNED BY:	Sarah Weight
CUSTOMER:	Phan-Nguyen	REVIEWED BY:	Sarah Weight
PROJ. ADDRESS:	-- Mercer Island, WA	PROJECT NAME:	Phan-Nguyen
LEVEL:	StruCalc Members	LOADING:	ASD
MEMBER NAME:	GT1 - HIP MASTER @ BR3 & 4 (end r...	CODE:	2018 International Building Code
MEMBER TYPE:	FLOOR BEAM	NDS:	2018 NDS
MATERIAL:	Solid Sawn		
Douglas Fir-Larch	No. 2	(1) 1.5 X 3.5	DRY

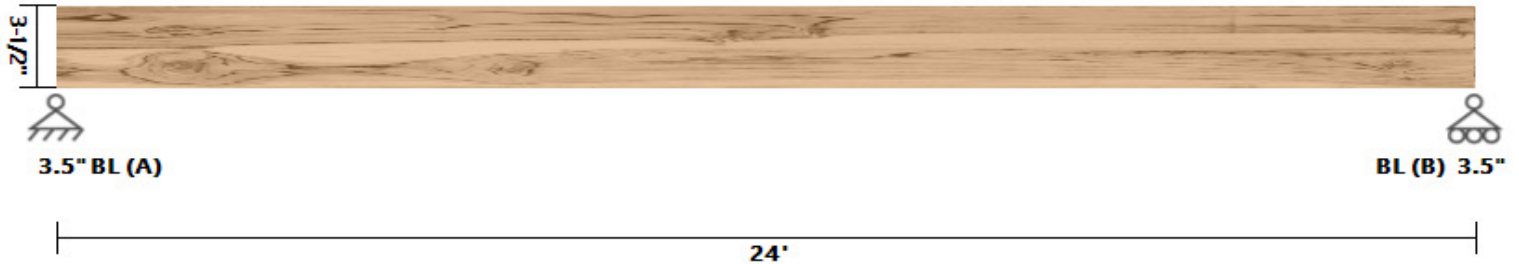
GT1 - HIP MASTER @ BR3 & 4 (end reactions only) DIAGRAM**BEAM PROPERTIES**

Start (ft): 0 End (ft): 24 Member Slope: 0/12 Actual Length (ft): 24

Area	I _x	I _y	BSW	Lams	G	K _{cr}
(in ²)	(in ⁴)	(in ⁴)	(lbf/ft)			Creep Factor
5.25	5.36	0.98	1.2	1	0.5	1

STRENGTH PROPERTIES

	F _b (psi)	F _t (psi)	F _v (psi)	F _c (psi)	F _{c⊥} (psi)	E (psi) x10 ³	E _{min} (psi) x10 ³
Base Values	900	575	180	1350	625	1600	580
Adjusted Values	1350	862	180	1552	625	1600	580
C _M	1	1	1	1	1	1	1
C _T	1	1	1	1	1	1	1
C _i	1	1	1	1	1	1	1
C _F	1.5	1.5	1	1.15	1	1	1

Bending Adjustment Factors C_{fu} = 1 C_r = 1**BEAM DATA**

Span	Length (ft)	Unbraced Length (ft)		Beam End				
		Top	Bottom	Elev. Diff (ft)	CL(Top)	CL(Bottom)	CL(Left)	CL(Right)
1	24	4	24	0	0.99	0.64	0.99	0.99

PASS-FAIL

	PASS/FAIL	MAGNITUDE	STRENGTH	LOCATION (ft)	LOAD COMBO	DURATION FACTOR CD
Shear Stress Y (psi)	PASS (97.5%)	4.1	162.0	24	D	0.9
Bending Stress Y (psi)	PASS (71.8%)	337.8	1199.1	12	D	0.9
Deflection (in)	PASS (13.1%)	1.042 (=L/276)	1.200 (=L/240)	12	D+L	
Bearing Stress (psi)	PASS (99.6%)	2.7	625.0	0	D	0.9

REACTIONS

Units for V: lbf Units for M: lbf-ft

Y axis	DEAD	TOTAL
A	14	14
B	14	14

Reaction Location

A

B

LOAD LIST

Type	Name	Left Magnitude	Right Magnitude	Load Start (ft)	Load End (ft)	Load Type	Direction
Self Weight (lbf/ft)	-	1.2	1.2	0	24	Dead	Y

PASS

DATE:	3/24/2023	COMPANY:	Architects Northwest
STRUCALC BUILD:	StruCalc Plus	DESIGNED BY:	Sarah Weight
CUSTOMER:	Phan-Nguyen	REVIEWED BY:	Sarah Weight
PROJ. ADDRESS:	-- Mercer Island, WA	PROJECT NAME:	Phan-Nguyen
LEVEL:	StruCalc Members	LOADING:	ASD
MEMBER NAME:	GT2 - HIP MASTER @ BR2 (end reac...	CODE:	2018 International Building Code
MEMBER TYPE:	FLOOR BEAM	NDS:	2018 NDS
MATERIAL:	Solid Sawn		
Douglas Fir-Larch	No. 2	(1) 1.5 X 3.5	DRY

GT2 - HIP MASTER @ BR2 (end reactions only) DIAGRAM**BEAM PROPERTIES**

Start (ft): 0 End (ft): 21.5 Member Slope: 0/12 Actual Length (ft): 21.5

Area	I _x	I _y	BSW	Lams	G	K _{cr}
(in ²)	(in ⁴)	(in ⁴)	(lbf/ft)			Creep Factor
5.25	5.36	0.98	1.2	1	0.5	1

STRENGTH PROPERTIES

	F _b (psi)	F _t (psi)	F _v (psi)	F _c (psi)	F _{c⊥} (psi)	E (psi) x10 ³	E _{min} (psi) x10 ³
Base Values	900	575	180	1350	625	1600	580
Adjusted Values	1350	862	180	1552	625	1600	580
C _M	1	1	1	1	1	1	1
C _T	1	1	1	1	1	1	1
C _i	1	1	1	1	1	1	1
C _F	1.5	1.5	1	1.15	1	1	1

Bending Adjustment Factors C_{fu} = 1 C_r = 1**BEAM DATA**

Span	Length (ft)	Unbraced Length (ft)		Beam End				
		Top	Bottom	Elev. Diff (ft)	CL(Top)	CL(Bottom)	CL(Left)	CL(Right)
1	21.5	4	21.5	0	0.99	0.70	0.99	0.99

PASS-FAIL

	PASS/FAIL	MAGNITUDE	STRENGTH	LOCATION (ft)	LOAD COMBO	DURATION FACTOR CD
Shear Stress Y (psi)	PASS (97.7%)	3.7	162.0	21.5	D	0.9
Bending Stress Y (psi)	PASS (77.4%)	271.1	1199.1	10.75	D	0.9
Deflection (in)	PASS (37.6%)	0.671 (=L/384)	1.075 (=L/240)	10.75	D+L	
Bearing Stress (psi)	PASS (99.6%)	2.5	625.0	0	D	0.9

REACTIONS

Units for V: lbf Units for M: lbf-ft

Y axis	DEAD	TOTAL
A	13	13
B	13	13

Reaction Location

A

B

LOAD LIST

Type	Name	Left Magnitude	Right Magnitude	Load Start (ft)	Load End (ft)	Load Type	Direction
Self Weight (lbf/ft)	-	1.2	1.2	0	21.5	Dead	Y

DATE:	3/24/2023	COMPANY:	Architects Northwest
STRUCALC BUILD:	StruCalc Plus	DESIGNED BY:	Sarah Weight
CUSTOMER:	Phan-Nguyen	REVIEWED BY:	Sarah Weight
PROJ. ADDRESS:	-- Mercer Island, WA	PROJECT NAME:	Phan-Nguyen
LEVEL:	StruCalc Members	LOADING:	ASD
MEMBER NAME:	GT3 - GIRDER TRUSS @ BA3 & WIC ...	CODE:	2018 International Building Code
MEMBER TYPE:	ROOF BEAM	NDS:	2018 NDS
MATERIAL:	Solid Sawn		
Douglas Fir-Larch	No. 2	(1) 1.5 X 3.5	DRY

GT3 - GIRDER TRUSS @ BA3 & WIC (end reactions only) DIAGRAM

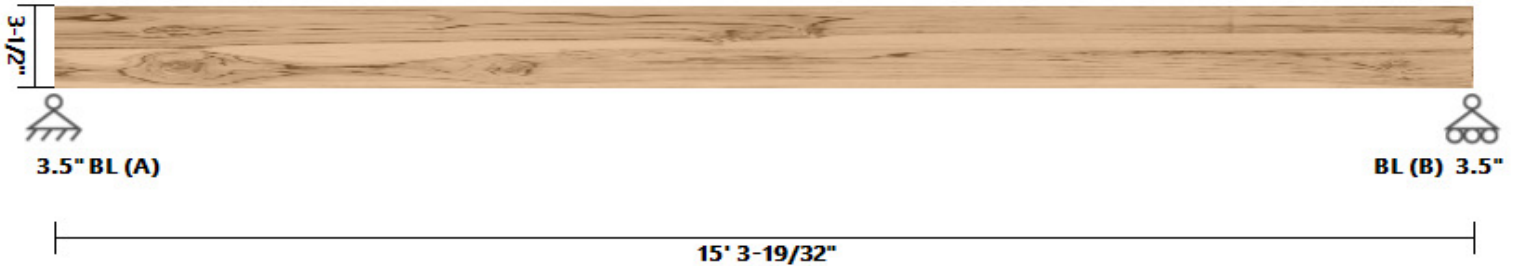

BEAM PROPERTIES

Start (ft): 0 End (ft): 15.3 Member Slope: 0/12 Actual Length (ft): 15.3

Area	I _x	I _y	BSW	Lams	G	K _{cr}
(in ²)	(in ⁴)	(in ⁴)	(lbf/ft)			Creep Factor
5.25	5.36	0.98	1.2	1	0.5	1

STRENGTH PROPERTIES

	F _b (psi)	F _t (psi)	F _v (psi)	F _c (psi)	F _{c⊥} (psi)	E (psi) x10 ³	E _{min} (psi) x10 ³
Base Values	900	575	180	1350	625	1600	580
Adjusted Values	1350	862	180	1552	625	1600	580
C _M	1	1	1	1	1	1	1
C _T	1	1	1	1	1	1	1
C _i	1	1	1	1	1	1	1
C _F	1.5	1.5	1	1.15	1	1	1

Bending Adjustment Factors C_{fu} = 1 C_r = 1

BEAM DATA

Span	Length (ft)	Unbraced Length (ft)		Beam End				
		Top	Bottom	Elev. Diff (ft)	CL(Top)	CL(Bottom)	CL(Left)	CL(Right)
1	15.3	2	15.3	0	0.99	0.70	0.99	0.99

PASS-FAIL

	PASS/FAIL	MAGNITUDE	STRENGTH	LOCATION (ft)	LOAD COMBO	DURATION FACTOR CD
Shear Stress Y (psi)	FAIL (-69.8%)	745.8	225.0	0	D+Lr	1.25
Bending Stress Y (psi)	FAIL (-95.7%)	39120.4	1668.6	7.65	D+Lr	1.25
Deflection (in)	FAIL (-98.4%)	49.059 (=L/4)	0.765 (=L/240)	7.65	D+Lr	
Bearing Stress (psi)	PASS (20.5%)	497.2	625.0	0	D+Lr	1.25

REACTIONS

Units for V: lbf Units for M: lbf-ft

Y axis	DEAD	LIVE ROOF	TOTAL
A	985	1626	2611
B	985	1626	2611

Reaction Location

A

B

LOAD LIST

Type	Name	Left Magnitude	Right Magnitude	Load Start (ft)	Load End (ft)	Load Type	Direction
Trapezoidal (lb/ft)	Trapezoidal	212.5	212.5	0	15.3	RoofLive	Y
Trapezoidal (lb/ft)	Trapezoidal	127.5	127.5	0	15.3	Dead	Y
Self Weight (lb/ft)	-	1.2	1.2	0	15.3	Dead	Y

DATE:	3/24/2023	COMPANY:	Architects Northwest
STRUCALC BUILD:	StruCalc Plus	DESIGNED BY:	Sarah Weight
CUSTOMER:	Phan-Nguyen	REVIEWED BY:	Sarah Weight
PROJ. ADDRESS:	-- Mercer Island, WA	PROJECT NAME:	Phan-Nguyen
LEVEL:	StruCalc Members	LOADING:	ASD
MEMBER NAME:	GT4 - HIP MASTER @ BR5 (end reac...	CODE:	2018 International Building Code
MEMBER TYPE:	ROOF BEAM	NDS:	2018 NDS
MATERIAL:	Solid Sawn		
Douglas Fir-Larch	No. 2	(1) 1.5 X 3.5	DRY

GT4 - HIP MASTER @ BR5 (end reactions only) DIAGRAM



BEAM PROPERTIES

Start (ft): 0 End (ft): 15.5 Member Slope: 0/12 Actual Length (ft): 15.5

Area	I _x	I _y	BSW	Lams	G	K _{cr}
(in ²)	(in ⁴)	(in ⁴)	(lbf/ft)			Creep Factor
5.25	5.36	0.98	1.2	1	0.5	1

STRENGTH PROPERTIES

	F _b (psi)	F _t (psi)	F _v (psi)	F _c (psi)	F _{c⊥} (psi)	E (psi) x10 ³	E _{min} (psi) x10 ³
Base Values	900	575	180	1350	625	1600	580
Adjusted Values	1350	862	180	1552	625	1600	580
C _M	1	1	1	1	1	1	1
C _T	1	1	1	1	1	1	1
C _i	1	1	1	1	1	1	1
C _F	1.5	1.5	1	1.15	1	1	1

Bending Adjustment Factors C_{fu} = 1 C_r = 1

BEAM DATA

Span	Length (ft)	Unbraced Length (ft)		Beam End				
		Top	Bottom	Elev. Diff (ft)	CL(Top)	CL(Bottom)	CL(Left)	CL(Right)
1	15.5	4	15.5	0	0.98	0.70	0.99	0.99

PASS-FAIL

	PASS/FAIL	MAGNITUDE	STRENGTH	LOCATION (ft)	LOAD COMBO	DURATION FACTOR CD
Shear Stress Y (psi)	FAIL (-47.6%)	429.5	225.0	15.5	D+Lr	1.25
Bending Stress Y (psi)	FAIL (-95.4%)	36095.9	1653.9	7.75	D+Lr	1.25
Deflection (in)	FAIL (-98.0%)	39.635 (=L/5)	0.775 (=L/240)	7.75	D+Lr	
Bearing Stress (psi)	PASS (54.2%)	286.3	625.0	0	D+Lr	1.25

REACTIONS

Units for V: lbf Units for M: lbf-ft

Y axis	DEAD	LIVE ROOF	TOTAL
A	583	921	1504
B	583	921	1504

Reaction Location

A

B

LOAD LIST

Type	Name	Left Magnitude	Right Magnitude	Load Start (ft)	Load End (ft)	Load Type	Direction
Trapezoidal (lbf/ft)	Trapezoidal	50	50	0	15.5	RoofLive	Y
Trapezoidal (lbf/ft)	Trapezoidal	30	30	0	15.5	Dead	Y
Axial (lbf)	Axial	341	341	7.75	0	Dead	Y
Axial (lbf)	Axial	533	533	7.75	0	RoofLive	Y
Axial (lbf)	Axial	341	341	7.75	0	Dead	Y
Axial (lbf)	Axial	533	533	7.75	0	RoofLive	Y
Self Weight (lbf/ft)	-	1.2	1.2	0	15.5	Dead	Y

DATE:	3/24/2023	COMPANY:	Architects Northwest
STRUCALC BUILD:	StruCalc Plus	DESIGNED BY:	Sarah Weight
CUSTOMER:	Phan-Nguyen	REVIEWED BY:	Sarah Weight
PROJ. ADDRESS:	-- Mercer Island, WA	PROJECT NAME:	Phan-Nguyen
LEVEL:	StruCalc Members	LOADING:	ASD
MEMBER NAME:	GT5 - GIRDER TRUSS @ BR5 (end re...	CODE:	2018 International Building Code
MEMBER TYPE:	FLOOR BEAM	NDS:	2018 NDS
MATERIAL:	Solid Sawn		
Douglas Fir-Larch	No. 2	(1) 1.5 X 3.5	DRY

GT5 - GIRDER TRUSS @ BR5 (end reactions only) DIAGRAM

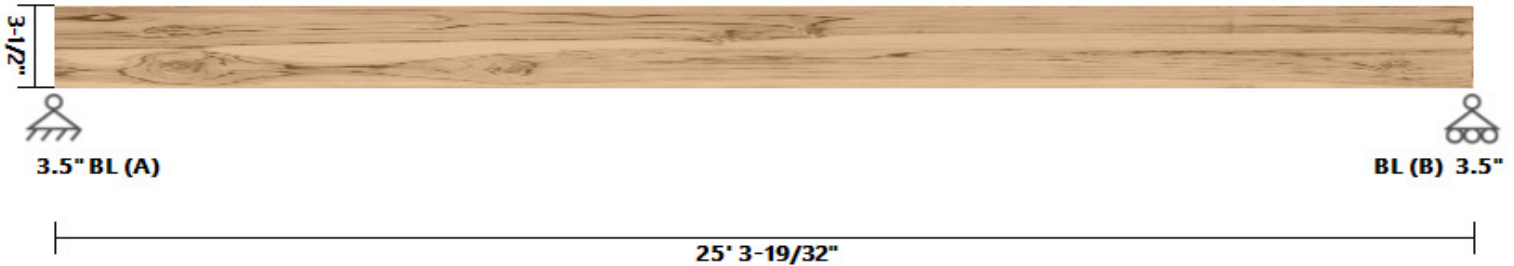

BEAM PROPERTIES

Start (ft): 0 End (ft): 25.3 Member Slope: 0/12 Actual Length (ft): 25.3

Area	I _x	I _y	BSW	Lams	G	K _{cr}
(in ²)	(in ⁴)	(in ⁴)	(lbf/ft)			Creep Factor
5.25	5.36	0.98	1.2	1	0.5	1

STRENGTH PROPERTIES

	F _b (psi)	F _t (psi)	F _v (psi)	F _c (psi)	F _{c⊥} (psi)	E (psi) x10 ³	E _{min} (psi) x10 ³
Base Values	900	575	180	1350	625	1600	580
Adjusted Values	1350	862	180	1552	625	1600	580
C _M	1	1	1	1	1	1	1
C _T	1	1	1	1	1	1	1
C _i	1	1	1	1	1	1	1
C _F	1.5	1.5	1	1.15	1	1	1

Bending Adjustment Factors C_{fu} = 1 C_r = 1

BEAM DATA

Span	Length (ft)	Unbraced Length (ft)		Beam End				
		Top	Bottom	Elev. Diff (ft)	CL(Top)	CL(Bottom)	CL(Left)	CL(Right)
1	25.3	2	25.3	0	0.99	0.46	0.99	0.99

PASS-FAIL

	PASS/FAIL	MAGNITUDE	STRENGTH	LOCATION (ft)	LOAD COMBO	DURATION FACTOR CD
Shear Stress Y (psi)	FAIL (-32.2%)	332.0	225.0	25.3	D+Lr	1.25
Bending Stress Y (psi)	FAIL (-93.9%)	27134.1	1668.6	19.23	D+Lr	1.25
Deflection (in)	FAIL (-98.2%)	69.702 (=L/4)	1.265 (=L/240)	14.17	D+Lr	
Bearing Stress (psi)	PASS (64.6%)	221.3	625.0	25.3	D+Lr	1.25

REACTIONS

Units for V: lbf Units for M: lbf-ft

Y axis	DEAD	LIVE ROOF	TOTAL
A	153	218	371
B	460	702	1162

Reaction Location

A

B

LOAD LIST

Type	Name	Left Magnitude	Right Magnitude	Load Start (ft)	Load End (ft)	Load Type	Direction
Self Weight (lbf/ft)	-	1.2	1.2	0	25.3	Dead	Y

LINKED LOAD LIST

Type	Left Magnitude	Right Magnitude	Load Start (ft)	Load End (ft)	Load Type	Direction
Point (lbf)	582.7798	-	19.3	-	Dead	Y
Point (lbf)	920.5002	-	19.3	-	RoofLive	Y

DATE:	3/24/2023	COMPANY:	Architects Northwest
STRUCALC BUILD:	StruCalc Plus	DESIGNED BY:	Sarah Weight
CUSTOMER:	Phan-Nguyen	REVIEWED BY:	Sarah Weight
PROJ. ADDRESS:	-- Mercer Island, WA	PROJECT NAME:	Phan-Nguyen
LEVEL:	StruCalc Members	LOADING:	ASD
MEMBER NAME:	GT6 - GIRDER TRUSS @ BR2 (end re...	CODE:	2018 International Building Code
MEMBER TYPE:	FLOOR BEAM	NDS:	2018 NDS
MATERIAL:	Solid Sawn		
Douglas Fir-Larch	No. 2	(1) 1.5 X 3.5	DRY

GT6 - GIRDER TRUSS @ BR2 (end reactions only) DIAGRAM



BEAM PROPERTIES

Start (ft): 0 End (ft): 21.5 Member Slope: 0/12 Actual Length (ft): 21.5

Area	I _x	I _y	BSW	Lams	G	K _{cr}
(in ²)	(in ⁴)	(in ⁴)	(lbf/ft)			Creep Factor
5.25	5.36	0.98	1.2	1	0.5	1

STRENGTH PROPERTIES

	F _b (psi)	F _t (psi)	F _v (psi)	F _c (psi)	F _{c⊥} (psi)	E (psi) x10 ³	E _{min} (psi) x10 ³
Base Values	900	575	180	1350	625	1600	580
Adjusted Values	1350	862	180	1552	625	1600	580
C _M	1	1	1	1	1	1	1
C _T	1	1	1	1	1	1	1
C _i	1	1	1	1	1	1	1
C _F	1.5	1.5	1	1.15	1	1	1

Bending Adjustment Factors C_{fu} = 1 C_r = 1

BEAM DATA

Span	Length (ft)	Unbraced Length (ft)		Beam End				
		Top	Bottom	Elev. Diff (ft)	CL(Top)	CL(Bottom)	CL(Left)	CL(Right)
1	21.5	4	21.5	0	0.98	0.53	0.99	0.99

PASS-FAIL

	PASS/FAIL	MAGNITUDE	STRENGTH	LOCATION (ft)	LOAD COMBO	DURATION FACTOR CD
Shear Stress Y (psi)	FAIL (-67.4%)	690.4	225.0	0	D+Lr	1.25
Bending Stress Y (psi)	FAIL (-92.4%)	21714.7	1653.9	2.37	D+Lr	1.25
Deflection (in)	FAIL (-97.6%)	44.112 (=L/6)	1.075 (=L/240)	9.68	D+Lr	
Bearing Stress (psi)	PASS (26.4%)	460.3	625.0	0	D+Lr	1.25

REACTIONS

Units for V: lbf Units for M: lbf-ft

Y axis	DEAD	LIVE ROOF	TOTAL
A	922	1494	2416
B	242	350	592

Reaction Location

A

B

LOAD LIST

Type	Name	Left Magnitude	Right Magnitude	Load Start (ft)	Load End (ft)	Load Type	Direction
Self Weight (lbf/ft)	-	1.2	1.2	0	21.5	Dead	Y

LINKED LOAD LIST

Type	Left Magnitude	Right Magnitude	Load Start (ft)	Load End (ft)	Load Type	Direction
Point (lbf)	984.5349	-	2.3	-	Dead	Y
Point (lbf)	1625.625	-	2.3	-	RoofLive	Y
Point (lbf)	153.3555	-	17.3	-	Dead	Y
Point (lbf)	218.3006	-	17.3	-	RoofLive	Y

DATE:	3/24/2023	COMPANY:	Architects Northwest
STRUCALC BUILD:	StruCalc Plus	DESIGNED BY:	Sarah Weight
CUSTOMER:	Phan-Nguyen	REVIEWED BY:	Sarah Weight
PROJ. ADDRESS:	-- Mercer Island, WA	PROJECT NAME:	Phan-Nguyen
LEVEL:	StruCalc Members	LOADING:	ASD
MEMBER NAME:	GT7 - GIRDER TRUSS @ BR3 & BR4 (...)	CODE:	2018 International Building Code
MEMBER TYPE:	FLOOR BEAM	NDS:	2018 NDS
MATERIAL:	Solid Sawn		
Douglas Fir-Larch	No. 2	(1) 1.5 X 3.5	DRY

GT7 - GIRDER TRUSS @ BR3 & BR4 (end reactions only) DIAGRAM

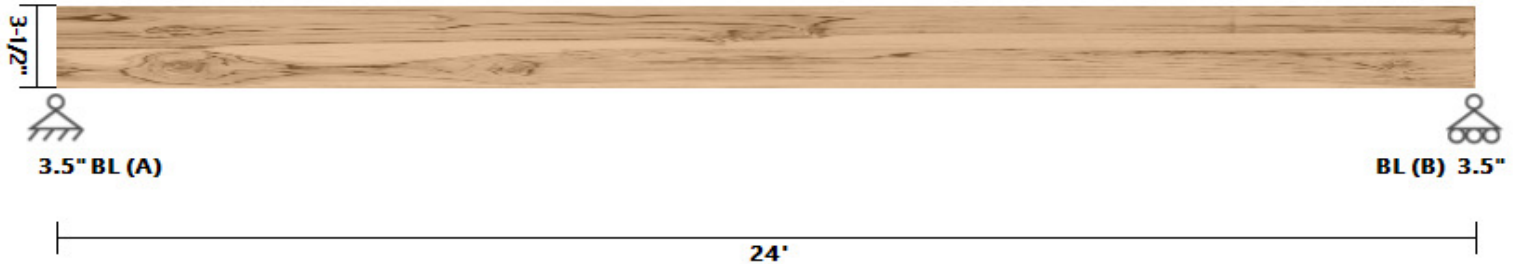

BEAM PROPERTIES

Start (ft): 0 End (ft): 24 Member Slope: 0/12 Actual Length (ft): 24

Area	Ix	Iy	BSW	Lams	G	Kcr
(in ²)	(in ⁴)	(in ⁴)	(lbf/ft)			Creep Factor
5.25	5.36	0.98	1.2	1	0.5	1

STRENGTH PROPERTIES

	Fb (psi)	Ft (psi)	Fv (psi)	Fc (psi)	Fc _⊥ (psi)	E (psi) x10 ³	Emin (psi) x10 ³
Base Values	900	575	180	1350	625	1600	580
Adjusted Values	1350	862	180	1552	625	1600	580
C _M	1	1	1	1	1	1	1
C _T	1	1	1	1	1	1	1
C _i	1	1	1	1	1	1	1
C _F	1.5	1.5	1	1.15	1	1	1

 Bending Adjustment Factors C_{fu} = 1 C_r = 1

BEAM DATA

Span	Length (ft)	Unbraced Length (ft)		Beam End				
		Top	Bottom	Elev. Diff (ft)	CL(Top)	CL(Bottom)	CL(Left)	CL(Right)
1	24	4	24	0	0.98	0.48	0.99	0.99

PASS-FAIL

	PASS/FAIL	MAGNITUDE	STRENGTH	LOCATION (ft)	LOAD COMBO	DURATION FACTOR CD
Shear Stress Y (psi)	FAIL (-50.6%)	455.6	225.0	0	D+Lr	1.25
Bending Stress Y (psi)	FAIL (-96.8%)	52201.5	1653.9	8.4	D+Lr	1.25
Deflection (in)	FAIL (-99.0%)	125.811 (=L/2)	1.200 (=L/240)	11.04	D+Lr	
Bearing Stress (psi)	PASS (51.4%)	303.8	625.0	0	D+Lr	1.25

REACTIONS

Units for V: lbf Units for M: lbf-ft

Y axis	DEAD	LIVE ROOF	TOTAL
A	623	971	1594
B	340	523	863

Reaction Location

A

B

LOAD LIST

Type	Name	Left Magnitude	Right Magnitude	Load Start (ft)	Load End (ft)	Load Type	Direction
Self Weight (lbf/ft)	-	1.2	1.2	0	24	Dead	Y

LINKED LOAD LIST

Type	Left Magnitude	Right Magnitude	Load Start (ft)	Load End (ft)	Load Type	Direction
Point (lbf)	12.87171	-	6	-	Dead	Y
Point (lbf)	922.041	-	8.4	-	Dead	Y
Point (lbf)	1494.361	-	8.4	-	RoofLive	Y

DATE:	3/24/2023	COMPANY:	Architects Northwest
STRUCALC BUILD:	StruCalc Plus	DESIGNED BY:	Sarah Weight
CUSTOMER:	Phan-Nguyen	REVIEWED BY:	Sarah Weight
PROJ. ADDRESS:	-- Mercer Island, WA	PROJECT NAME:	Phan-Nguyen
LEVEL:	StruCalc Members	LOADING:	ASD
MEMBER NAME:	GT8 - GIRDER TRUSS @ GREAT RM (...)	CODE:	2018 International Building Code
MEMBER TYPE:	FLOOR BEAM	NDS:	2018 NDS
MATERIAL:	Solid Sawn		
Douglas Fir-Larch	No. 2	(1) 1.5 X 3.5	DRY

GT8 - GIRDER TRUSS @ GREAT RM (end reactions only) DIAGRAM

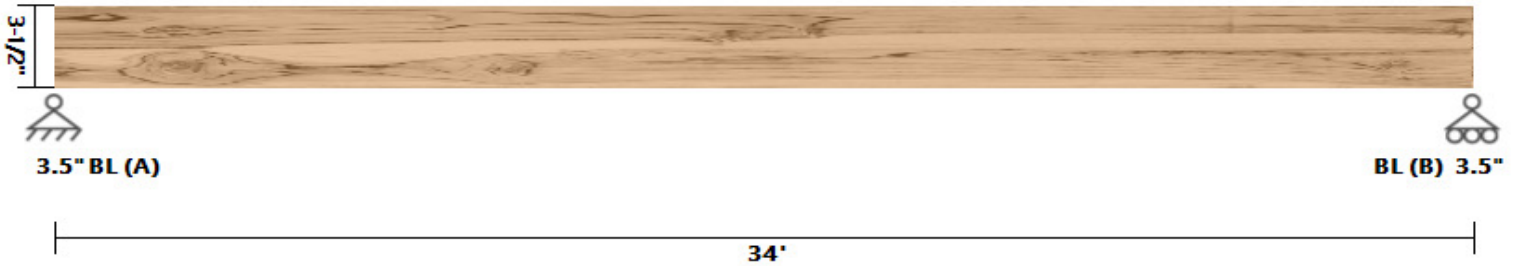

BEAM PROPERTIES

Start (ft): 0 End (ft): 34 Member Slope: 0/12 Actual Length (ft): 34

Area	I _x	I _y	BSW	Lams	G	K _{cr}
(in ²)	(in ⁴)	(in ⁴)	(lbf/ft)			Creep Factor
5.25	5.36	0.98	1.2	1	0.5	1

STRENGTH PROPERTIES

	F _b (psi)	F _t (psi)	F _v (psi)	F _c (psi)	F _{c⊥} (psi)	E (psi) x10 ³	E _{min} (psi) x10 ³
Base Values	900	575	180	1350	625	1600	580
Adjusted Values	1350	862	180	1552	625	1600	580
C _M	1	1	1	1	1	1	1
C _T	1	1	1	1	1	1	1
C _i	1	1	1	1	1	1	1
C _F	1.5	1.5	1	1.15	1	1	1

Bending Adjustment Factors C_{fu} = 1 C_r = 1

BEAM DATA

Span	Length (ft)	Unbraced Length (ft)		Beam End				
		Top	Bottom	Elev. Diff (ft)	CL(Top)	CL(Bottom)	CL(Left)	CL(Right)
1	34	4	34	0	0.98	0.34	0.99	0.99

PASS-FAIL

	PASS/FAIL	MAGNITUDE	STRENGTH	LOCATION (ft)	LOAD COMBO	DURATION FACTOR CD
Shear Stress Y (psi)	PASS (39.5%)	136.0	225.0	0	D+Lr	1.25
Bending Stress Y (psi)	FAIL (-89.2%)	15328.6	1653.9	8.5	D+Lr	1.25
Deflection (in)	FAIL (-97.7%)	72.753 (=L/6)	1.700 (=L/240)	14.96	D+Lr	
Bearing Stress (psi)	PASS (85.5%)	90.7	625.0	0	D+Lr	1.25

REACTIONS

Units for V: lbf Units for M: lbf-ft

Y axis	DEAD	LIVE ROOF	TOTAL
A	213	263	476
B	82	86	168

Reaction Location

A

B

LOAD LIST

Type	Name	Left Magnitude	Right Magnitude	Load Start (ft)	Load End (ft)	Load Type	Direction
Self Weight (lbf/ft)	-	1.2	1.2	0	34	Dead	Y

LINKED LOAD LIST

Type	Left Magnitude	Right Magnitude	Load Start (ft)	Load End (ft)	Load Type	Direction
Point (lbf)	12.87171	-	6	-	Dead	Y
Point (lbf)	241.5914	-	8.4	-	Dead	Y
Point (lbf)	349.5596	-	8.4	-	RoofLive	Y

PASS

DATE:	3/24/2023	COMPANY:	Architects Northwest
STRUCALC BUILD:	StruCalc Plus	DESIGNED BY:	Sarah Weight
CUSTOMER:	Phan-Nguyen	REVIEWED BY:	Sarah Weight
PROJ. ADDRESS:	-- Mercer Island, WA	PROJECT NAME:	Phan-Nguyen
LEVEL:	StruCalc Members	LOADING:	ASD
MEMBER NAME:	GT9 - HIP MASTER @ STAIRS (end r...	CODE:	2018 International Building Code
MEMBER TYPE:	FLOOR BEAM	NDS:	2018 NDS
MATERIAL:	Solid Sawn		
Douglas Fir-Larch	No. 2	(1) 1.5 X 3.5	DRY

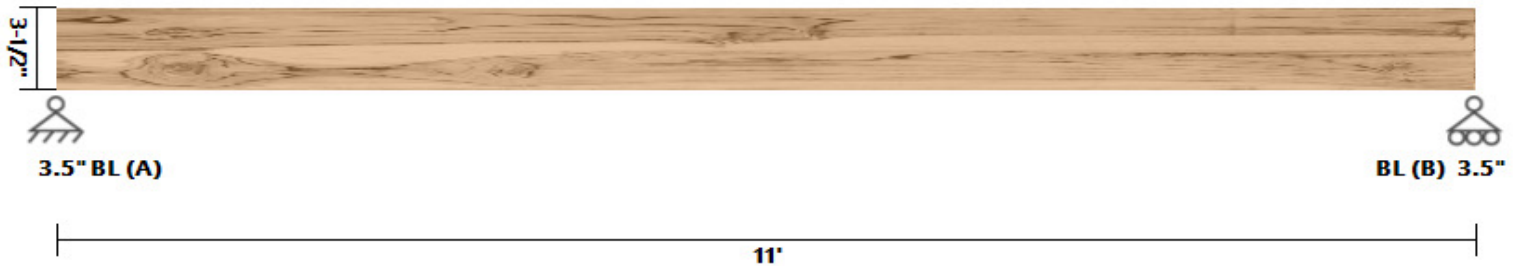
GT9 - HIP MASTER @ STAIRS (end reactions only) DIAGRAM**BEAM PROPERTIES**

Start (ft): 0 End (ft): 11 Member Slope: 0/12 Actual Length (ft): 11

Area	I _x	I _y	BSW	Lams	G	K _{cr}
(in ²)	(in ⁴)	(in ⁴)	(lbf/ft)			Creep Factor
5.25	5.36	0.98	1.2	1	0.5	1

STRENGTH PROPERTIES

	F _b (psi)	F _t (psi)	F _v (psi)	F _c (psi)	F _{c⊥} (psi)	E (psi) x10 ³	E _{min} (psi) x10 ³
Base Values	900	575	180	1350	625	1600	580
Adjusted Values	1350	862	180	1552	625	1600	580
C _M	1	1	1	1	1	1	1
C _T	1	1	1	1	1	1	1
C _i	1	1	1	1	1	1	1
C _F	1.5	1.5	1	1.15	1	1	1

Bending Adjustment Factors C_{fu} = 1 C_r = 1**BEAM DATA**

Span	Length (ft)	Unbraced Length (ft)		Beam End				
		Top	Bottom	Elev. Diff (ft)	CL(Top)	CL(Bottom)	CL(Left)	CL(Right)
1	11	4	11	0	0.99	0.93	1.00	1.00

PASS-FAIL

	PASS/FAIL	MAGNITUDE	STRENGTH	LOCATION (ft)	LOAD COMBO	DURATION FACTOR CD
Shear Stress Y (psi)	PASS (98.8%)	1.9	162.0	0	D	0.9
Bending Stress Y (psi)	PASS (94.1%)	71.0	1199.1	5.5	D	0.9
Deflection (in)	PASS (91.6%)	0.046 (=L/2870)	0.550 (=L/240)	5.5	D+L	
Bearing Stress (psi)	PASS (99.8%)	1.3	625.0	0	D	0.9

REACTIONS

Units for V: lbf Units for M: lbf-ft

Y axis	DEAD	TOTAL
A	7	7
B	7	7

Reaction Location

A

B

LOAD LIST

Type	Name	Left Magnitude	Right Magnitude	Load Start (ft)	Load End (ft)	Load Type	Direction
Self Weight (lbf/ft)	-	1.2	1.2	0	11	Dead	Y

DATE:	3/24/2023	COMPANY:	Architects Northwest
STRUCALC BUILD:	StruCalc Plus	DESIGNED BY:	Sarah Weight
CUSTOMER:	Phan-Nguyen	REVIEWED BY:	Sarah Weight
PROJ. ADDRESS:	--	PROJECT NAME:	Phan-Nguyen
	, Mercer Island, WA		
LEVEL:	StruCalc Members	LOADING:	ASD
MEMBER NAME:	GT10 - GIRDER TRUSS @ STAIR (end ...	CODE:	2018 International Building Code
MEMBER TYPE:	ROOF BEAM	NDS:	2018 NDS
MATERIAL:	Solid Sawn		
Douglas Fir-Larch	No. 2	(1) 1.5 X 3.5	DRY

GT10 - GIRDER TRUSS @ STAIR (end reactions only) DIAGRAM

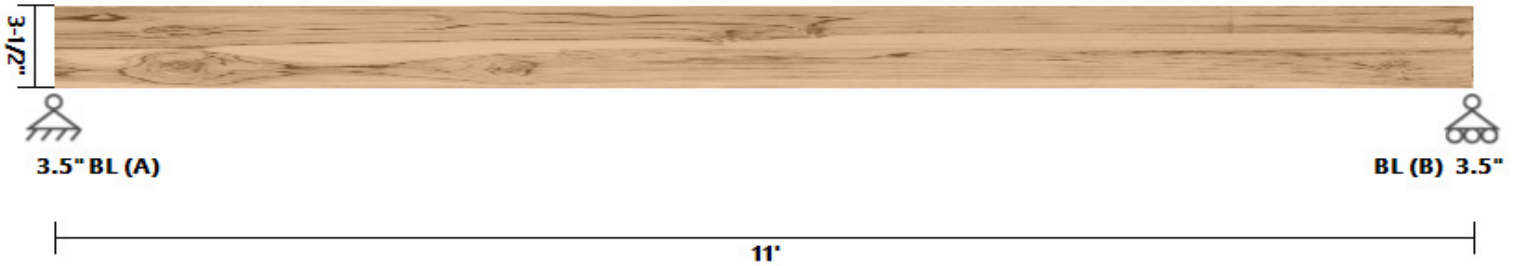

BEAM PROPERTIES

Start (ft): 0 End (ft): 11 Member Slope: 0/12 Actual Length (ft): 11

Area	I _x	I _y	BSW	Lams	G	K _{cr}
(in ²)	(in ⁴)	(in ⁴)	(lbf/ft)			Creep Factor
5.25	5.36	0.98	1.2	1	0.5	1

STRENGTH PROPERTIES

	F _b (psi)	F _t (psi)	F _v (psi)	F _c (psi)	F _{c⊥} (psi)	E (psi) x10 ³	E _{min} (psi) x10 ³
Base Values	900	575	180	1350	625	1600	580
Adjusted Values	1350	862	180	1552	625	1600	580
C _M	1	1	1	1	1	1	1
C _T	1	1	1	1	1	1	1
C _i	1	1	1	1	1	1	1
C _F	1.5	1.5	1	1.15	1	1	1

Bending Adjustment Factors C_{fu} = 1 C_r = 1

BEAM DATA

Span	Length (ft)	Unbraced Length (ft)		Beam End				
		Top	Bottom	Elev. Diff (ft)	CL(Top)	CL(Bottom)	CL(Left)	CL(Right)
1	11	2	11	0	0.99	0.85	1.00	1.00

PASS-FAIL

	PASS/FAIL	MAGNITUDE	STRENGTH	LOCATION (ft)	LOAD COMBO	DURATION FACTOR CD
Shear Stress Y (psi)	FAIL (-73.9%)	863.0	225.0	0	D+Lr	1.25
Bending Stress Y (psi)	FAIL (-94.9%)	32548.3	1668.6	5.5	D+Lr	1.25
Deflection (in)	FAIL (-97.4%)	21.098 (=L/6)	0.550 (=L/240)	5.5	D+Lr	
Bearing Stress (psi)	PASS (7.9%)	575.3	625.0	0	D+Lr	1.25

REACTIONS

Units for V: lbf Units for M: lbf-ft

Y axis	DEAD	LIVE ROOF	TOTAL
A	1137	1884	3021
B	1137	1884	3021

Reaction Location

A

B

LOAD LIST

Type	Name	Left Magnitude	Right Magnitude	Load Start (ft)	Load End (ft)	Load Type	Direction
Trapezoidal (lb/ft)	Trapezoidal	342.5	342.5	0	11	RoofLive	Y
Trapezoidal (lb/ft)	Trapezoidal	205.5	205.5	0	11	Dead	Y
Self Weight (lb/ft)	-	1.2	1.2	0	11	Dead	Y

DATE:	3/24/2023	COMPANY:	Architects Northwest
STRUCALC BUILD:	StruCalc Plus	DESIGNED BY:	Sarah Weight
CUSTOMER:	Phan-Nguyen	REVIEWED BY:	Sarah Weight
PROJ. ADDRESS:	-- Mercer Island, WA	PROJECT NAME:	Phan-Nguyen
LEVEL:	StruCalc Members	LOADING:	ASD
MEMBER NAME:	GT11 - GIRDER TRUSS @ GREAT RM ...	CODE:	2018 International Building Code
MEMBER TYPE:	FLOOR BEAM	NDS:	2018 NDS
MATERIAL:	Solid Sawn		
Douglas Fir-Larch	No. 2	(1) 1.5 X 3.5	DRY

GT11 - GIRDER TRUSS @ GREAT RM (end reactions only) DIAGRAM

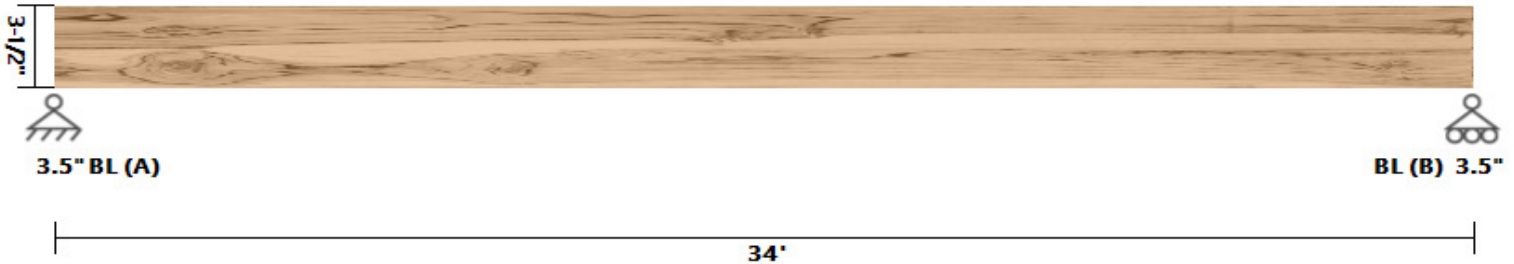

BEAM PROPERTIES

Start (ft): 0 End (ft): 34 Member Slope: 0/12 Actual Length (ft): 34

Area	I _x	I _y	BSW	Lams	G	K _{cr}
(in ²)	(in ⁴)	(in ⁴)	(lbf/ft)			Creep Factor
5.25	5.36	0.98	1.2	1	0.5	1

STRENGTH PROPERTIES

	F _b (psi)	F _t (psi)	F _v (psi)	F _c (psi)	F _{c⊥} (psi)	E (psi) x10 ³	E _{min} (psi) x10 ³
Base Values	900	575	180	1350	625	1600	580
Adjusted Values	1350	862	180	1552	625	1600	580
C _M	1	1	1	1	1	1	1
C _T	1	1	1	1	1	1	1
C _i	1	1	1	1	1	1	1
C _F	1.5	1.5	1	1.15	1	1	1

Bending Adjustment Factors C_{fu} = 1 C_r = 1

BEAM DATA

Span	Length (ft)	Unbraced Length (ft)		Beam End				
		Top	Bottom	Elev. Diff (ft)	CL(Top)	CL(Bottom)	CL(Left)	CL(Right)
1	34	4	34	0	0.98	0.34	0.99	0.99

PASS-FAIL

	PASS/FAIL	MAGNITUDE	STRENGTH	LOCATION (ft)	LOAD COMBO	DURATION FACTOR CD
Shear Stress Y (psi)	FAIL (-65.8%)	657.3	225.0	0	D+Lr	1.25
Bending Stress Y (psi)	FAIL (-97.8%)	75131.7	1653.9	8.5	D+Lr	1.25
Deflection (in)	FAIL (-99.5%)	349.450 (=L/1)	1.700 (=L/240)	14.96	D+Lr	
Bearing Stress (psi)	PASS (29.9%)	438.2	625.0	0	D+Lr	1.25

REACTIONS

Units for V: lbf Units for M: lbf-ft

Y axis	DEAD	LIVE ROOF	TOTAL
A	882	1418	2300
B	302	465	767

Reaction Location

A

B

LOAD LIST

Type	Name	Left Magnitude	Right Magnitude	Load Start (ft)	Load End (ft)	Load Type	Direction
Self Weight (lbf/ft)	-	1.2	1.2	0	34	Dead	Y

LINKED LOAD LIST

Type	Left Magnitude	Right Magnitude	Load Start (ft)	Load End (ft)	Load Type	Direction
Point (lbf)	6.585527	-	3	-	Dead	Y
Point (lbf)	1136.836	-	8.4	-	Dead	Y
Point (lbf)	1883.75	-	8.4	-	RoofLive	Y

DATE:	3/24/2023	COMPANY:	Architects Northwest
STRUCALC BUILD:	StruCalc Plus	DESIGNED BY:	Sarah Weight
CUSTOMER:	Phan-Nguyen	REVIEWED BY:	Sarah Weight
PROJ. ADDRESS:	-- Mercer Island, WA	PROJECT NAME:	Phan-Nguyen
LEVEL:	StruCalc Members	LOADING:	ASD
MEMBER NAME:	GT12 - GIRDER TRUSS @ MBR & ST...	CODE:	2018 International Building Code
MEMBER TYPE:	FLOOR BEAM	NDS:	2018 NDS
MATERIAL:	Solid Sawn		
Douglas Fir-Larch	No. 2	(1) 1.5 X 3.5	DRY

GT12 - GIRDER TRUSS @ MBR & STAIR (end reactions only) DIAGRAM

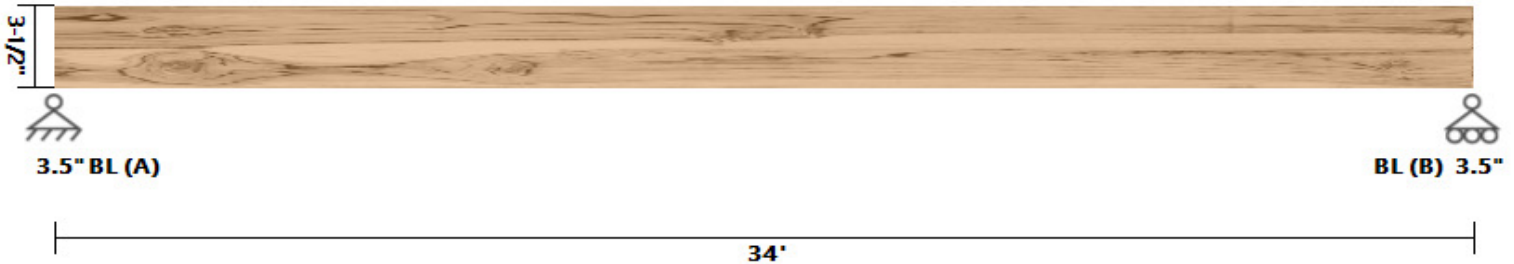

BEAM PROPERTIES

Start (ft): 0 End (ft): 34 Member Slope: 0/12 Actual Length (ft): 34

Area	I _x	I _y	BSW	Lams	G	K _{cr}
(in ²)	(in ⁴)	(in ⁴)	(lbf/ft)			Creep Factor
5.25	5.36	0.98	1.2	1	0.5	1

STRENGTH PROPERTIES

	F _b (psi)	F _t (psi)	F _v (psi)	F _c (psi)	F _{c⊥} (psi)	E (psi) x10 ³	E _{min} (psi) x10 ³
Base Values	900	575	180	1350	625	1600	580
Adjusted Values	1350	862	180	1552	625	1600	580
C _M	1	1	1	1	1	1	1
C _T	1	1	1	1	1	1	1
C _i	1	1	1	1	1	1	1
C _F	1.5	1.5	1	1.15	1	1	1

Bending Adjustment Factors C_{fu} = 1 C_r = 1

BEAM DATA

Span	Length (ft)	Unbraced Length (ft)		Beam End				
		Top	Bottom	Elev. Diff (ft)	CL(Top)	CL(Bottom)	CL(Left)	CL(Right)
1	34	4	34	0	0.98	0.34	0.99	0.99

PASS-FAIL

	PASS/FAIL	MAGNITUDE	STRENGTH	LOCATION (ft)	LOAD COMBO	DURATION FACTOR CD
Shear Stress Y (psi)	FAIL (-65.8%)	657.3	225.0	0	D+Lr	1.25
Bending Stress Y (psi)	FAIL (-97.8%)	75131.7	1653.9	8.5	D+Lr	1.25
Deflection (in)	FAIL (-99.5%)	349.450 (=L/1)	1.700 (=L/240)	14.96	D+Lr	
Bearing Stress (psi)	PASS (29.9%)	438.2	625.0	0	D+Lr	1.25

REACTIONS

Units for V: lbf Units for M: lbf-ft

Y axis	DEAD	LIVE ROOF	TOTAL
A	882	1418	2300
B	302	465	767

Reaction Location

A

B

LOAD LIST

Type	Name	Left Magnitude	Right Magnitude	Load Start (ft)	Load End (ft)	Load Type	Direction
Self Weight (lbf/ft)	-	1.2	1.2	0	34	Dead	Y

LINKED LOAD LIST

Type	Left Magnitude	Right Magnitude	Load Start (ft)	Load End (ft)	Load Type	Direction
Point (lbf)	6.585527	-	3	-	Dead	Y
Point (lbf)	1136.836	-	8.4	-	Dead	Y
Point (lbf)	1883.75	-	8.4	-	RoofLive	Y

DATE:	3/24/2023	COMPANY:	Architects Northwest
STRUCALC BUILD:	StruCalc Plus	DESIGNED BY:	Sarah Weight
CUSTOMER:	Phan-Nguyen	REVIEWED BY:	Sarah Weight
PROJ. ADDRESS:	-- Mercer Island, WA	PROJECT NAME:	Phan-Nguyen
LEVEL:	StruCalc Members	LOADING:	ASD
MEMBER NAME:	GT13 - HIP MASTER @ MBA @ LDY (...)	CODE:	2018 International Building Code
MEMBER TYPE:	FLOOR BEAM	NDS:	2018 NDS
MATERIAL:	Solid Sawn		
Douglas Fir-Larch	No. 2	(1) 1.5 X 3.5	DRY

GT13 - HIP MASTER @ MBA @ LDY (end reactions only) DIAGRAM

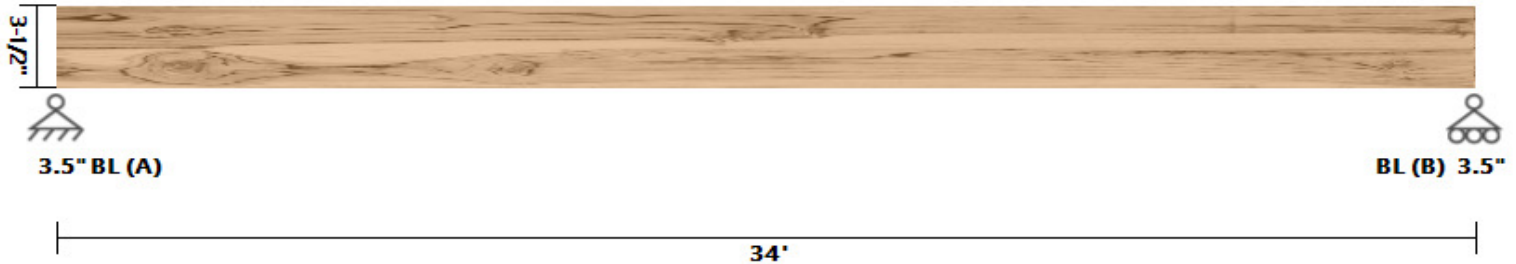

BEAM PROPERTIES

Start (ft): 0 End (ft): 34 Member Slope: 0/12 Actual Length (ft): 34

Area	I _x	I _y	BSW	Lams	G	K _{cr}
(in ²)	(in ⁴)	(in ⁴)	(lbf/ft)			Creep Factor
5.25	5.36	0.98	1.2	1	0.5	1

STRENGTH PROPERTIES

	F _b (psi)	F _t (psi)	F _v (psi)	F _c (psi)	F _{c⊥} (psi)	E (psi) x10 ³	E _{min} (psi) x10 ³
Base Values	900	575	180	1350	625	1600	580
Adjusted Values	1350	862	180	1552	625	1600	580
C _M	1	1	1	1	1	1	1
C _T	1	1	1	1	1	1	1
C _i	1	1	1	1	1	1	1
C _F	1.5	1.5	1	1.15	1	1	1

 Bending Adjustment Factors C_{fu} = 1 C_r = 1

BEAM DATA

Span	Length (ft)	Unbraced Length (ft)		Beam End				
		Top	Bottom	Elev. Diff (ft)	CL(Top)	CL(Bottom)	CL(Left)	CL(Right)
1	34	2	34	0	0.99	0.47	0.99	0.99

PASS-FAIL

	PASS/FAIL	MAGNITUDE	STRENGTH	LOCATION (ft)	LOAD COMBO	DURATION FACTOR CD
Shear Stress Y (psi)	PASS (96.4%)	5.8	162.0	0	D	0.9
Bending Stress Y (psi)	PASS (43.8%)	678.0	1205.7	17	D	0.9
Deflection (in)	FAIL (-59.5%)	4.199 (=L/97)	1.700 (=L/240)	17	D+L	
Bearing Stress (psi)	PASS (99.4%)	3.9	625.0	0	D	0.9

REACTIONS

Units for V: lbf Units for M: lbf-ft

Y axis	DEAD	TOTAL
A	20	20
B	20	20

Reaction Location

A

B

LOAD LIST

Type	Name	Left Magnitude	Right Magnitude	Load Start (ft)	Load End (ft)	Load Type	Direction
Self Weight (lbf/ft)	-	1.2	1.2	0	34	Dead	Y

DATE:	3/24/2023	COMPANY:	Architects Northwest
STRUCALC BUILD:	StruCalc Plus	DESIGNED BY:	Sarah Weight
CUSTOMER:	Phan-Nguyen	REVIEWED BY:	Sarah Weight
PROJ. ADDRESS:	-- Mercer Island, WA	PROJECT NAME:	Phan-Nguyen
LEVEL:	StruCalc Members	LOADING:	ASD
MEMBER NAME:	GT14 - GIRDER TRUSS at MBR (end r...	CODE:	2018 International Building Code
MEMBER TYPE:	FLOOR BEAM	NDS:	2018 NDS
MATERIAL:	Solid Sawn		
Douglas Fir-Larch	No. 2	(1) 1.5 X 3.5	DRY

GT14 - GIRDER TRUSS at MBR (end reactions only) DIAGRAM



BEAM PROPERTIES

Start (ft): 0 End (ft): 18 Member Slope: 0/12 Actual Length (ft): 18

Area	I _x	I _y	BSW	Lams	G	K _{cr}
(in ²)	(in ⁴)	(in ⁴)	(lbf/ft)			Creep Factor
5.25	5.36	0.98	1.2	1	0.5	1

STRENGTH PROPERTIES

	F _b (psi)	F _t (psi)	F _v (psi)	F _c (psi)	F _{c⊥} (psi)	E (psi) x10 ³	E _{min} (psi) x10 ³
Base Values	900	575	180	1350	625	1600	580
Adjusted Values	1350	862	180	1552	625	1600	580
C _M	1	1	1	1	1	1	1
C _T	1	1	1	1	1	1	1
C _i	1	1	1	1	1	1	1
C _F	1.5	1.5	1	1.15	1	1	1

Bending Adjustment Factors C_{fu} = 1 C_r = 1

BEAM DATA

Span	Length (ft)	Unbraced Length (ft)		Beam End				
		Top	Bottom	Elev. Diff (ft)	CL(Top)	CL(Bottom)	CL(Left)	CL(Right)
1	18	4	18	0	0.98	0.62	0.99	0.99

PASS-FAIL

	PASS/FAIL	MAGNITUDE	STRENGTH	LOCATION (ft)	LOAD COMBO	DURATION FACTOR CD
Shear Stress Y (psi)	PASS (40.7%)	133.5	225.0	0	D+Lr	1.25
Bending Stress Y (psi)	FAIL (-87.8%)	13529.9	1653.9	7.56	D+Lr	1.25
Deflection (in)	FAIL (-95.2%)	18.922 (=L/11)	0.900 (=L/240)	8.64	D+Lr	
Bearing Stress (psi)	PASS (85.8%)	89.0	625.0	0	D+Lr	1.25

REACTIONS

Units for V: lbf Units for M: lbf-ft

Y axis	DEAD	LIVE ROOF	TOTAL
A	196	271	467
B	148	194	342

Reaction Location

A

B

LOAD LIST

Type	Name	Left Magnitude	Right Magnitude	Load Start (ft)	Load End (ft)	Load Type	Direction
Self Weight (lbf/ft)	-	1.2	1.2	0	18	Dead	Y

LINKED LOAD LIST

Type	Left Magnitude	Right Magnitude	Load Start (ft)	Load End (ft)	Load Type	Direction
Point (lbf)	301.8013	-	7.5	-	Dead	Y
Point (lbf)	465.3965	-	7.5	-	RoofLive	Y
Point (lbf)	20.35526	-	10	-	Dead	Y

PASS

DATE:	3/24/2023	COMPANY:	Architects Northwest
STRUCALC BUILD:	StruCalc Plus	DESIGNED BY:	Sarah Weight
CUSTOMER:	Phan-Nguyen	REVIEWED BY:	Sarah Weight
PROJ. ADDRESS:	-- Mercer Island, WA	PROJECT NAME:	Phan-Nguyen
LEVEL:	StruCalc Members	LOADING:	ASD
MEMBER NAME:	GT15 - HIP MASTER @ MBR (end re...	CODE:	2018 International Building Code
MEMBER TYPE:	FLOOR BEAM	NDS:	2018 NDS
MATERIAL:	Solid Sawn		
Douglas Fir-Larch	No. 2	(1) 1.5 X 3.5	DRY

GT15 - HIP MASTER @ MBR (end reactions only) DIAGRAM**BEAM PROPERTIES**

Start (ft): 0 End (ft): 18 Member Slope: 0/12 Actual Length (ft): 18

Area	I _x	I _y	BSW	Lams	G	K _{cr}
(in ²)	(in ⁴)	(in ⁴)	(lbf/ft)			Creep Factor
5.25	5.36	0.98	1.2	1	0.5	1

STRENGTH PROPERTIES

	F _b (psi)	F _t (psi)	F _v (psi)	F _c (psi)	F _{c⊥} (psi)	E (psi) x10 ³	E _{min} (psi) x10 ³
Base Values	900	575	180	1350	625	1600	580
Adjusted Values	1350	862	180	1552	625	1600	580
C _M	1	1	1	1	1	1	1
C _T	1	1	1	1	1	1	1
C _i	1	1	1	1	1	1	1
C _F	1.5	1.5	1	1.15	1	1	1

Bending Adjustment Factors C_{fu} = 1 C_r = 1**BEAM DATA**

Span	Length (ft)	Unbraced Length (ft)		Beam End				
		Top	Bottom	Elev. Diff (ft)	CL(Top)	CL(Bottom)	CL(Left)	CL(Right)
1	18	4	18	0	0.99	0.78	1.00	1.00

PASS-FAIL

	PASS/FAIL	MAGNITUDE	STRENGTH	LOCATION (ft)	LOAD COMBO	DURATION FACTOR CD
Shear Stress Y (psi)	PASS (98.1%)	3.1	162.0	18	D	0.9
Bending Stress Y (psi)	PASS (84.2%)	190.0	1199.1	9	D	0.9
Deflection (in)	PASS (63.4%)	0.330 (=L/655)	0.900 (=L/240)	9	D+L	
Bearing Stress (psi)	PASS (99.7%)	2.1	625.0	0	D	0.9

REACTIONS

Units for V: lbf Units for M: lbf-ft

Y axis	DEAD	TOTAL
A	11	11
B	11	11

Reaction Location

A

B

LOAD LIST

Type	Name	Left Magnitude	Right Magnitude	Load Start (ft)	Load End (ft)	Load Type	Direction
Self Weight (lbf/ft)	-	1.2	1.2	0	18	Dead	Y

PASS

DATE:	3/24/2023	COMPANY:	Architects Northwest
STRUCALC BUILD:	StruCalc Plus	DESIGNED BY:	Sarah Weight
CUSTOMER:	Phan-Nguyen	REVIEWED BY:	Sarah Weight
PROJ. ADDRESS:	-- Mercer Island, WA	PROJECT NAME:	Phan-Nguyen
LEVEL:	StruCalc Members	LOADING:	ASD
MEMBER NAME:	R01 - BR3 WDO HDR	CODE:	2018 International Building Code
MEMBER TYPE:	FLOOR BEAM	NDS:	2018 NDS
MATERIAL:	Solid Sawn		
Douglas Fir-Larch	No. 2	(1) 5.5 X 11.5	DRY

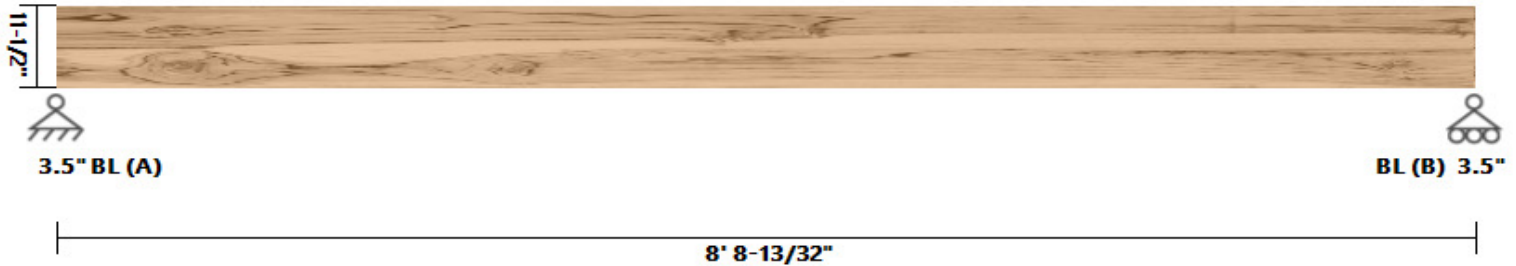
R01 - BR3 WDO HDR DIAGRAM**BEAM PROPERTIES**

Start (ft): 0 End (ft): 8.7 Member Slope: 0/12 Actual Length (ft): 8.7

Area	I _x	I _y	BSW	Lams	G	K _{cr}
(in ²)	(in ⁴)	(in ⁴)	(lbf/ft)			Creep Factor
63.25	697.07	159.44	14.43	1	0.5	1

STRENGTH PROPERTIES

	F _b (psi)	F _t (psi)	F _v (psi)	F _c (psi)	F _{c⊥} (psi)	E (psi) x10 ³	E _{min} (psi) x10 ³
Base Values	875	425	170	600	625	1300	470
Adjusted Values	875	425	170	600	625	1300	470
C _M	1	1	1	1	1	1	1
C _T	1	1	1	1	1	1	1
C _i	1	1	1	1	1	1	1
C _F	1	1	1	1	1	1	1

Bending Adjustment Factors C_{fu} = 1 C_r = 1**BEAM DATA**

Span	Length (ft)	Unbraced Length (ft)		Beam End				
		Top	Bottom	Elev. Diff (ft)	CL(Top)	CL(Bottom)	CL(Left)	CL(Right)
1	8.7	2	8.7	0	1.00	1.00	1.00	1.00

PASS-FAIL

	PASS/FAIL	MAGNITUDE	STRENGTH	LOCATION (ft)	LOAD COMBO	DURATION FACTOR CD
Shear Stress Y (psi)	PASS (98.9%)	1.7	153.0	8.7	D	0.9
Bending Stress Y (psi)	PASS (98.0%)	15.5	786.4	4.7	D	0.9
Deflection (in)	PASS (99.5%)	0.002 (=L/43500)	0.435 (=L/240)	4.44	D+L	
Bearing Stress (psi)	PASS (99.4%)	3.8	625.0	8.7	D	0.9

REACTIONS

Units for V: lbf Units for M: lbf-ft

Y axis	DEAD	TOTAL
A	67	67
B	73	73

Reaction Location

A

B

LOAD LIST

Type	Name	Left Magnitude	Right Magnitude	Load Start (ft)	Load End (ft)	Load Type	Direction
Self Weight (lbf/ft)	-	14.43	14.43	0	8.7	Dead	Y

LINKED LOAD LIST

Type	Left Magnitude	Right Magnitude	Load Start (ft)	Load End (ft)	Load Type	Direction
Point (lbf)	14.36842	-	6	-	Dead	Y

PASS

DATE:	3/24/2023	COMPANY:	Architects Northwest
STRUCALC BUILD:	StruCalc Plus	DESIGNED BY:	Sarah Weight
CUSTOMER:	Phan-Nguyen	REVIEWED BY:	Sarah Weight
PROJ. ADDRESS:	-- Mercer Island, WA	PROJECT NAME:	Phan-Nguyen
LEVEL:	StruCalc Members	LOADING:	ASD
MEMBER NAME:	R02 - BR2 WDO HDR	CODE:	2018 International Building Code
MEMBER TYPE:	FLOOR BEAM	NDS:	2018 NDS
MATERIAL:	Glulams		
Stress Class Rated 24F-1.8E	24F-V4 DF/DF	(1) 5.125 X 12	DRY

R02 - BR2 WDO HDR DIAGRAM

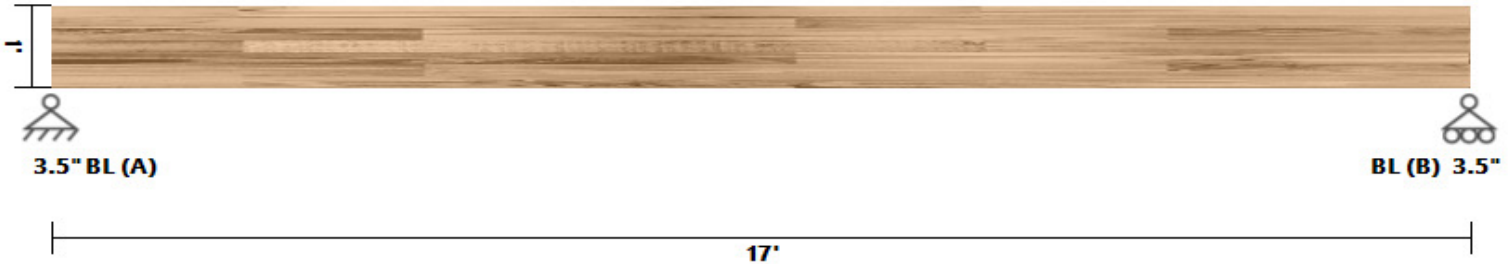

BEAM PROPERTIES

Start (ft): 0 End (ft): 17 Member Slope: 0/12 Actual Length (ft): 17

Area	Ix	Iy	BSW	Lams	G	Kcr
(in ²)	(in ⁴)	(in ⁴)	(lbf/ft)			Creep Factor
61.5	738	134.61	14.03	1	0.5	1

STRENGTH PROPERTIES

	Fbx+	Fbx-	Fby	Ft	Fvx	Fvy	Fc	Fc _⊥	Ex	Exmin	Ey	Eymin
	(psi)	(psi)	(psi)	(psi)	(psi)	(psi)	(psi)	(psi)	(psi)	(psi)	(psi)	(psi)
Base Values	2400	1850	1450	1100	265	230	1650	650	1800000	950000	1600000	850000
Adjusted Values	2400	1850	1450	1100	265	230	1650	650	1800000	950000	1600000	850000
C _M	1	1	1	1	1	1	1	1	1	1	1	1
C _T	1	1	1	1	1	1	1	1	1	1	1	1

Bending Adjustment Factors C_{Vr} = 1

BEAM DATA

Span	Length (ft)	Unbraced Length (ft)		Beam End		CL(Left)	CL(Right)
		Top	Bottom	Elev. Diff (ft)	CL(Top)		
1	17	2	17	0	1.00	0.98	1.00

PASS-FAIL

	PASS/FAIL	MAGNITUDE	STRENGTH	LOCATION (ft)	LOAD COMBO	DURATION FACTOR CD
Shear Stress Y (psi)	PASS (98.8%)	2.9	238.5	0	D	0.9
Bending Stress Y (psi)	PASS (97.7%)	49.4	2154.6	8.5	D	0.9
Deflection (in)	PASS (97.7%)	0.020 (=L/10303)	0.850 (=L/240)	8.5	D+L	
Bearing Stress (psi)	PASS (98.8%)	6.6	560.0	0	D	0.9

REACTIONS

Units for V: lbf Units for M: lbf-ft

Y axis	DEAD	TOTAL
A	119	119
B	119	119

Reaction Location



LOAD LIST

Type	Name	Left Magnitude	Right Magnitude	Load Start (ft)	Load End (ft)	Load Type	Direction
Self Weight (lbf/ft)	-	14.03	14.03	0	17	Dead	Y

PASS

DATE:	3/24/2023	COMPANY:	Architects Northwest
STRUCALC BUILD:	StruCalc Plus	DESIGNED BY:	Sarah Weight
CUSTOMER:	Phan-Nguyen	REVIEWED BY:	Sarah Weight
PROJ. ADDRESS:	-- Mercer Island, WA	PROJECT NAME:	Phan-Nguyen
LEVEL:	StruCalc Members	LOADING:	ASD
MEMBER NAME:	R03 - COV'D DECK BEAM	CODE:	2018 International Building Code
MEMBER TYPE:	FLOOR BEAM	NDS:	2018 NDS
MATERIAL:	Glulams		
Stress Class Rated 24F-1.8E	24F-V4 DF/DF	(1) 5.125 X 12	DRY

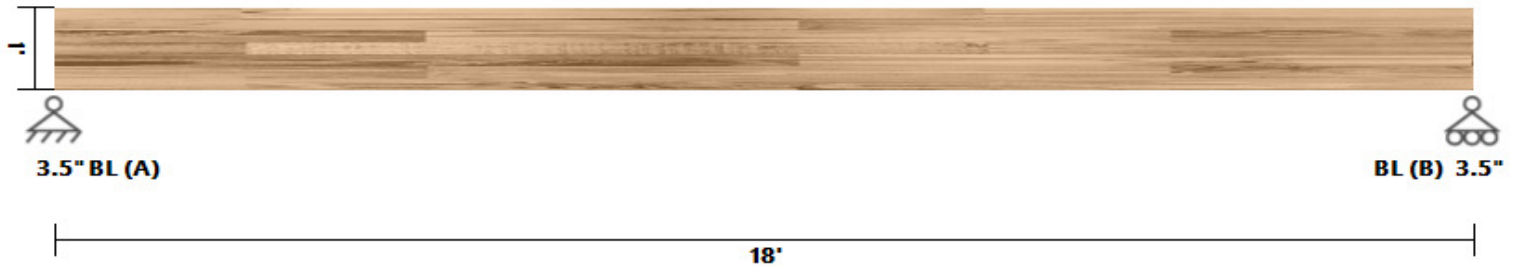
R03 - COV'D DECK BEAM DIAGRAM**BEAM PROPERTIES**

Start (ft): 0 End (ft): 18 Member Slope: 0/12 Actual Length (ft): 18

Area	Ix	Iy	BSW	Lams	G	Kcr
(in ²)	(in ⁴)	(in ⁴)	(lbf/ft)			Creep Factor
61.5	738	134.61	14.03	1	0.5	1

STRENGTH PROPERTIES

	Fbx+	Fbx-	Fby	Ft	Fvx	Fvy	Fc	Fc _⊥	Ex	Exmin	Ey	Eymin
	(psi)	(psi)	(psi)	(psi)	(psi)	(psi)	(psi)	(psi)	(psi)	(psi)	(psi)	(psi)
Base Values	2400	1850	1450	1100	265	230	1650	650	1800000	950000	1600000	850000
Adjusted Values	2400	1850	1450	1100	265	230	1650	650	1800000	950000	1600000	850000
C _M	1	1	1	1	1	1	1	1	1	1	1	1
C _T	1	1	1	1	1	1	1	1	1	1	1	1
Bending Adjustment Factors	C _{Vr} = 1											

BEAM DATA

Span	Length (ft)	Unbraced Length (ft)		Beam End		CL(Top)	CL(Bottom)	CL(Left)	CL(Right)
		Top	Bottom	Elev. Diff (ft)					
1	18	2	18	0		1.00	0.98	1.00	1.00

PASS-FAIL

	PASS/FAIL	MAGNITUDE	STRENGTH	LOCATION (ft)	LOAD COMBO	DURATION FACTOR CD
Shear Stress Y (psi)	PASS (98.7%)	3.1	238.5	18	D	0.9
Bending Stress Y (psi)	PASS (97.4%)	55.4	2154.6	9	D	0.9
Deflection (in)	PASS (97.2%)	0.025 (=L/8675)	0.900 (=L/240)	9	D+L	
Bearing Stress (psi)	PASS (98.7%)	7.0	560.0	0	D	0.9

REACTIONS

Units for V: lbf Units for M: lbf-ft

Y axis	DEAD	TOTAL
A	126	126
B	126	126

Reaction Location

A

B

LOAD LIST

Type	Name	Left Magnitude	Right Magnitude	Load Start (ft)	Load End (ft)	Load Type	Direction
Self Weight (lbf/ft)	-	14.03	14.03	0	18	Dead	Y

PASS

DATE:	3/24/2023	COMPANY:	Architects Northwest
STRUCALC BUILD:	StruCalc Plus	DESIGNED BY:	Sarah Weight
CUSTOMER:	Phan-Nguyen	REVIEWED BY:	Sarah Weight
PROJ. ADDRESS:	-- Mercer Island, WA	PROJECT NAME:	Phan-Nguyen
LEVEL:	StruCalc Members	LOADING:	ASD
MEMBER NAME:	R04 - GREAT ROOM WDO HDR	CODE:	2018 International Building Code
MEMBER TYPE:	ROOF BEAM	NDS:	2018 NDS
MATERIAL:	Solid Sawn		
Douglas Fir-Larch	No. 2	(1) 3.5 X 11.25	DRY

R04 - GREAT ROOM WDO HDR DIAGRAM

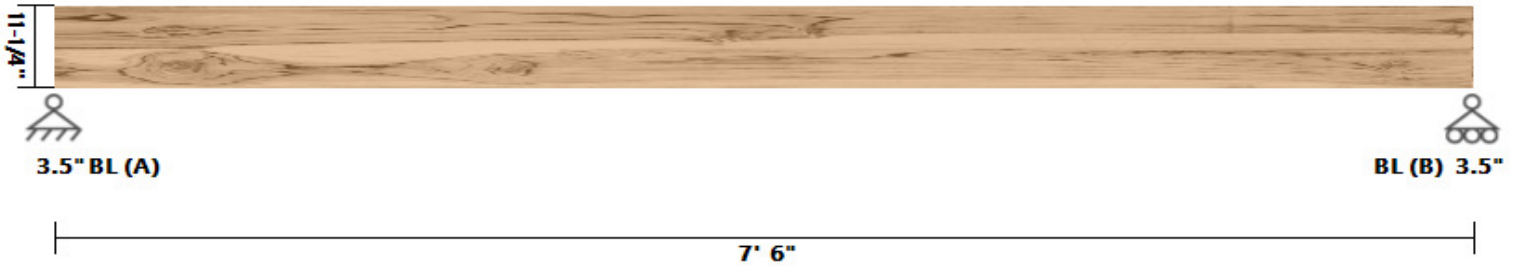

BEAM PROPERTIES

Start (ft): 0 End (ft): 7.5 Member Slope: 0/12 Actual Length (ft): 7.5

Area	Ix	Iy	BSW	Lams	G	Kcr
(in ²)	(in ⁴)	(in ⁴)	(lbf/ft)			Creep Factor
39.38	415.28	40.2	8.98	1	0.5	1

STRENGTH PROPERTIES

	Fb (psi)	Ft (psi)	Fv (psi)	Fc (psi)	Fc⊥ (psi)	E (psi) x10 ³	Emin (psi) x10 ³
Base Values	900	575	180	1350	625	1600	580
Adjusted Values	990	575	180	1350	625	1600	580
C _M	1	1	1	1	1	1	1
C _T	1	1	1	1	1	1	1
C _i	1	1	1	1	1	1	1
C _F	1.1	1	1	1	1	1	1

Bending Adjustment Factors C_{fu} = 1 C_r = 1

BEAM DATA

Span	Length (ft)	Unbraced Length (ft)		Beam End				
		Top	Bottom	Elev. Diff (ft)	CL(Top)	CL(Bottom)	CL(Left)	CL(Right)
1	7.5	2	7.5	0	1.00	0.99	1.00	1.00

PASS-FAIL

	PASS/FAIL	MAGNITUDE	STRENGTH	LOCATION (ft)	LOAD COMBO	DURATION FACTOR CD
Shear Stress Y (psi)	PASS (51.2%)	109.9	225.0	7.5	D+Lr	1.25
Bending Stress Y (psi)	PASS (28.7%)	878.8	1232.1	3.75	D+Lr	1.25
Deflection (in)	PASS (78.0%)	0.082 (=L/1092)	0.375 (=L/240)	3.75	D+Lr	
Bearing Stress (psi)	PASS (62.3%)	235.4	625.0	0	D+Lr	1.25

REACTIONS

Units for V: lbf Units for M: lbf-ft

Y axis	DEAD	LIVE ROOF	TOTAL
A	1102	1781	2883
B	1102	1781	2883

Reaction Location



LOAD LIST

Type	Name	Left Magnitude	Right Magnitude	Load Start (ft)	Load End (ft)	Load Type	Direction
Trapezoidal (lb/ft)	Trapezoidal	475	475	0	7.5	RoofLive	Y
Trapezoidal (lb/ft)	Trapezoidal	285	285	0	7.5	Dead	Y
Self Weight (lb/ft)	-	8.98	8.98	0	7.5	Dead	Y

PASS

DATE:	3/24/2023	COMPANY:	Architects Northwest
STRUCALC BUILD:	StruCalc Plus	DESIGNED BY:	Sarah Weight
CUSTOMER:	Phan-Nguyen	REVIEWED BY:	Sarah Weight
PROJ. ADDRESS:	-- Mercer Island, WA	PROJECT NAME:	Phan-Nguyen
LEVEL:	StruCalc Members	LOADING:	ASD
MEMBER NAME:	R05 - GREAT ROOM WDO HDR SIDE...	CODE:	2018 International Building Code
MEMBER TYPE:	ROOF BEAM	NDS:	2018 NDS
MATERIAL:	Solid Sawn		
Douglas Fir-Larch	No. 2	(1) 3.5 X 11.25	DRY

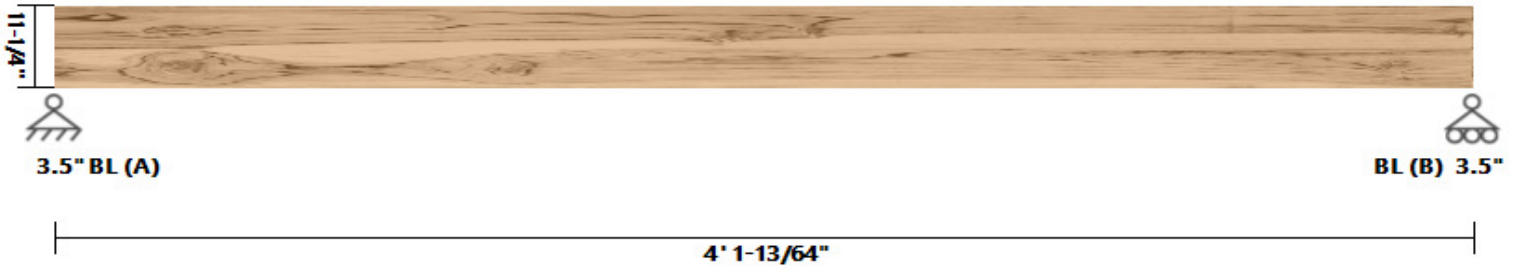
R05 - GREAT ROOM WDO HDR SIDES DIAGRAM**BEAM PROPERTIES**

Start (ft): 0 End (ft): 4.1 Member Slope: 0/12 Actual Length (ft): 4.1

Area	I _x	I _y	BSW	Lams	G	K _{cr}
(in ²)	(in ⁴)	(in ⁴)	(lbf/ft)			Creep Factor
39.38	415.28	40.2	8.98	1	0.5	1

STRENGTH PROPERTIES

	F _b (psi)	F _t (psi)	F _v (psi)	F _c (psi)	F _{c⊥} (psi)	E (psi) x10 ³	E _{min} (psi) x10 ³
Base Values	900	575	180	1350	625	1600	580
Adjusted Values	990	575	180	1350	625	1600	580
C _M	1	1	1	1	1	1	1
C _T	1	1	1	1	1	1	1
C _i	1	1	1	1	1	1	1
C _F	1.1	1	1	1	1	1	1

Bending Adjustment Factors C_{fu} = 1 C_r = 1**BEAM DATA**

Span	Length (ft)	Unbraced Length (ft)		Beam End				
		Top	Bottom	Elev. Diff (ft)	CL(Top)	CL(Bottom)	CL(Left)	CL(Right)
1	4.1	2	4.1	0	1.00	0.99	1.00	1.00

PASS-FAIL

	PASS/FAIL	MAGNITUDE	STRENGTH	LOCATION (ft)	LOAD COMBO	DURATION FACTOR CD
Shear Stress Y (psi)	PASS (71.6%)	64.0	225.0	0	D+Lr	1.25
Bending Stress Y (psi)	PASS (76.9%)	285.0	1232.1	1.97	D+Lr	1.25
Deflection (in)	PASS (96.1%)	0.008 (=L/6228)	0.205 (=L/240)	2.05	D+Lr	
Bearing Stress (psi)	PASS (78.1%)	137.1	625.0	0	D+Lr	1.25

REACTIONS

Units for V: lbf Units for M: lbf-ft

Y axis	DEAD	LIVE ROOF	TOTAL
A	653	1026	1679
B	635	1007	1642

Reaction Location

A

B

LOAD LIST

Type	Name	Left Magnitude	Right Magnitude	Load Start (ft)	Load End (ft)	Load Type	Direction
Trapezoidal (lbf/ft)	Trapezoidal	475	475	0	4.1	RoofLive	Y
Trapezoidal (lbf/ft)	Trapezoidal	285	285	0	4.1	Dead	Y
Self Weight (lbf/ft)	-	8.98	8.98	0	4.1	Dead	Y

LINKED LOAD LIST

Type	Left Magnitude	Right Magnitude	Load Start (ft)	Load End (ft)	Load Type	Direction
Point (lbf)	82.31476	-	1.6	-	Dead	Y
Point (lbf)	86.36269	-	1.6	-	RoofLive	Y

PASS

DATE:	3/24/2023	COMPANY:	Architects Northwest
STRUCALC BUILD:	StruCalc Plus	DESIGNED BY:	Sarah Weight
CUSTOMER:	Phan-Nguyen	REVIEWED BY:	Sarah Weight
PROJ. ADDRESS:	-- Mercer Island, WA	PROJECT NAME:	Phan-Nguyen
LEVEL:	StruCalc Members	LOADING:	ASD
MEMBER NAME:	R06 - COV'D PATIO BEAM	CODE:	2018 International Building Code
MEMBER TYPE:	ROOF BEAM	NDS:	2018 NDS
MATERIAL:	Solid Sawn		
Douglas Fir-Larch	No. 2	(1) 3.5 X 11.25	DRY

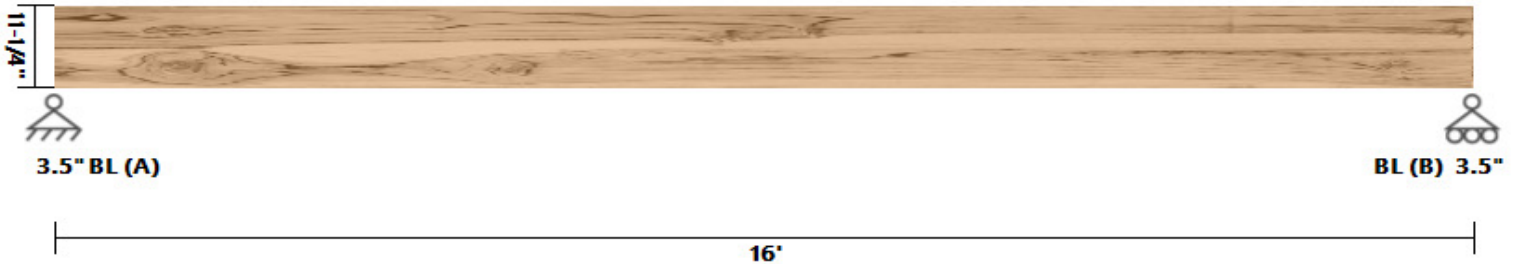
R06 - COV'D PATIO BEAM DIAGRAM**BEAM PROPERTIES**

Start (ft): 0 End (ft): 16 Member Slope: 0/12 Actual Length (ft): 16

Area	I _x	I _y	BSW	Lams	G	K _{cr}
(in ²)	(in ⁴)	(in ⁴)	(lb/ft)			Creep Factor
39.38	415.28	40.2	8.98	1	0.5	1

STRENGTH PROPERTIES

	F _b (psi)	F _t (psi)	F _v (psi)	F _c (psi)	F _{c⊥} (psi)	E (psi) x10 ³	E _{min} (psi) x10 ³
Base Values	900	575	180	1350	625	1600	580
Adjusted Values	990	575	180	1350	625	1600	580
C _M	1	1	1	1	1	1	1
C _T	1	1	1	1	1	1	1
C _i	1	1	1	1	1	1	1
C _F	1.1	1	1	1	1	1	1

Bending Adjustment Factors C_{fu} = 1 C_r = 1**BEAM DATA**

Span	Length (ft)	Unbraced Length (ft)		Beam End				
		Top	Bottom	Elev. Diff (ft)	CL(Top)	CL(Bottom)	CL(Left)	CL(Right)
1	16	2	16	0	1.00	0.94	1.00	1.00

PASS-FAIL

	PASS/FAIL	MAGNITUDE	STRENGTH	LOCATION (ft)	LOAD COMBO	DURATION FACTOR CD
Shear Stress Y (psi)	PASS (77.1%)	51.5	225.0	0	D+Lr	1.25
Bending Stress Y (psi)	PASS (28.7%)	878.9	1232.1	8	D+Lr	1.25
Deflection (in)	PASS (53.1%)	0.375 (=L/512)	0.800 (=L/240)	8	D+Lr	
Bearing Stress (psi)	PASS (82.3%)	110.4	625.0	0	D+Lr	1.25

REACTIONS

Units for V: lbf Units for M: lbf-ft

Y axis	DEAD	LIVE ROOF	TOTAL
A	552	800	1352
B	552	800	1352

Reaction Location

A

B

LOAD LIST

Type	Name	Left Magnitude	Right Magnitude	Load Start (ft)	Load End (ft)	Load Type	Direction
Trapezoidal (lb/ft)	Trapezoidal	100	100	0	16	RoofLive	Y
Trapezoidal (lb/ft)	Trapezoidal	60	60	0	16	Dead	Y
Self Weight (lb/ft)	-	8.98	8.98	0	16	Dead	Y

DATE:	3/24/2023	COMPANY:	Architects Northwest
STRUCALC BUILD:	StruCalc Plus	DESIGNED BY:	Sarah Weight
CUSTOMER:	Phan-Nguyen	REVIEWED BY:	Sarah Weight
PROJ. ADDRESS:	-- Mercer Island, WA	PROJECT NAME:	Phan-Nguyen
LEVEL:	StruCalc Members	LOADING:	ASD
MEMBER NAME:	R07 - BR4 WDO HDR	CODE:	2018 International Building Code
MEMBER TYPE:	FLOOR BEAM	NDS:	2018 NDS
MATERIAL:	Solid Sawn		
Douglas Fir-Larch	No. 2	(1) 3.5 X 9.25	DRY

R07 - BR4 WDO HDR DIAGRAM

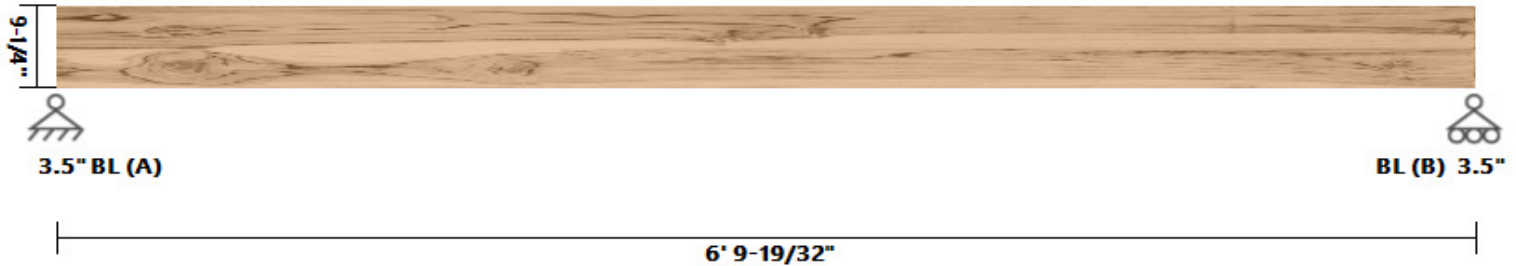

BEAM PROPERTIES

Start (ft): 0 End (ft): 6.8 Member Slope: 0/12 Actual Length (ft): 6.8

Area	I _x	I _y	BSW	Lams	G	K _{cr}
(in ²)	(in ⁴)	(in ⁴)	(lbf/ft)			Creep Factor
32.38	230.84	33.05	7.38	1	0.5	1

STRENGTH PROPERTIES

	F _b (psi)	F _t (psi)	F _v (psi)	F _c (psi)	F _{c⊥} (psi)	E (psi) x10 ³	E _{min} (psi) x10 ³
Base Values	900	575	180	1350	625	1600	580
Adjusted Values	1080	632	180	1350	625	1600	580
C _M	1	1	1	1	1	1	1
C _T	1	1	1	1	1	1	1
C _i	1	1	1	1	1	1	1
C _F	1.2	1.1	1	1	1	1	1

Bending Adjustment Factors C_{fu} = 1 C_r = 1

BEAM DATA

Span	Length (ft)	Unbraced Length (ft)		Beam End				
		Top	Bottom	Elev. Diff (ft)	CL(Top)	CL(Bottom)	CL(Left)	CL(Right)
1	6.8	2	6.8	0	1.00	0.99	1.00	1.00

PASS-FAIL

	PASS/FAIL	MAGNITUDE	STRENGTH	LOCATION (ft)	LOAD COMBO	DURATION FACTOR CD
Shear Stress Y (psi)	PASS (99.0%)	1.7	162.0	6.8	D	0.9
Bending Stress Y (psi)	PASS (98.6%)	13.6	969.3	3.94	D	0.9
Deflection (in)	PASS (99.6%)	0.001 (=L/62769)	0.340 (=L/240)	3.47	D+L	
Bearing Stress (psi)	PASS (99.5%)	2.9	625.0	6.8	D	0.9

REACTIONS

Units for V: lbf Units for M: lbf-ft

Y axis	DEAD	TOTAL
A	29	29
B	36	36

Reaction Location

A

B

LOAD LIST

Type	Name	Left Magnitude	Right Magnitude	Load Start (ft)	Load End (ft)	Load Type	Direction
Self Weight (lbf/ft)	-	7.38	7.38	0	6.8	Dead	Y

LINKED LOAD LIST

Type	Left Magnitude	Right Magnitude	Load Start (ft)	Load End (ft)	Load Type	Direction
Point (lbf)	14.36842	-	5	-	Dead	Y

DATE:	3/24/2023	COMPANY:	Architects Northwest
STRUCALC BUILD:	StruCalc Plus	DESIGNED BY:	Sarah Weight
CUSTOMER:	Phan-Nguyen	REVIEWED BY:	Sarah Weight
PROJ. ADDRESS:	-- Mercer Island, WA	PROJECT NAME:	Phan-Nguyen
LEVEL:	StruCalc Members	LOADING:	ASD
MEMBER NAME:	U01 - BR6 WDO HDR	CODE:	2018 International Building Code
MEMBER TYPE:	FLOOR BEAM	NDS:	2018 NDS
MATERIAL:	Solid Sawn		
Douglas Fir-Larch	No. 2	(1) 5.5 X 11.5	DRY

U01 - BR6 WDO HDR DIAGRAM

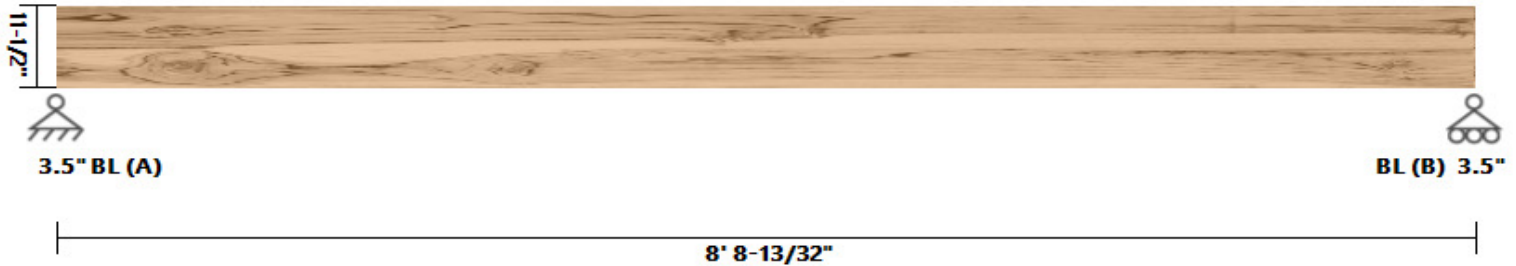

BEAM PROPERTIES

Start (ft): 0 End (ft): 8.7 Member Slope: 0/12 Actual Length (ft): 8.7

Area	Ix	Iy	BSW	Lams	G	Kcr
(in ²)	(in ⁴)	(in ⁴)	(lbf/ft)			Creep Factor
63.25	697.07	159.44	14.43	1	0.5	1

STRENGTH PROPERTIES

	Fb (psi)	Ft (psi)	Fv (psi)	Fc (psi)	Fc⊥ (psi)	E (psi) x10 ³	Emin (psi) x10 ³
Base Values	875	425	170	600	625	1300	470
Adjusted Values	875	425	170	600	625	1300	470
C _M	1	1	1	1	1	1	1
C _T	1	1	1	1	1	1	1
C _i	1	1	1	1	1	1	1
C _F	1	1	1	1	1	1	1

Bending Adjustment Factors C_{fu} = 1 C_r = 1

BEAM DATA

Span	Length (ft)	Unbraced Length (ft)		Beam End				
		Top	Bottom	Elev. Diff (ft)	CL(Top)	CL(Bottom)	CL(Left)	CL(Right)
1	8.7	2	8.7	0	1.00	0.99	1.00	1.00

PASS-FAIL

	PASS/FAIL	MAGNITUDE	STRENGTH	LOCATION (ft)	LOAD COMBO	DURATION FACTOR	CD
Shear Stress Y (psi)	PASS (60.3%)	67.5	170.0	0	D+L	1	
Bending Stress Y (psi)	PASS (29.9%)	612.9	873.7	4.35	D+L	1	
Deflection (in)	PASS (67.9%)	0.093 (=L/1121)	0.290 (=L/360)	4.35	D+L		
Bearing Stress (psi)	PASS (76.3%)	147.9	625.0	0	D+L	1	

REACTIONS

Units for V: lbf Units for M: lbf-ft

Y axis	DEAD	LIVE	TOTAL
A	1107	1740	2847
B	1107	1740	2847

Reaction Location

A

B

LOAD LIST

Type	Name	Left Magnitude	Right Magnitude	Load Start (ft)	Load End (ft)	Load Type	Direction
Trapezoidal (lb/ft)	Trapezoidal	400	400	0	8.7	Live	Y
Trapezoidal (lb/ft)	Trapezoidal	150	150	0	8.7	Dead	Y
Trapezoidal (lb/ft)	Trapezoidal	90	90	0	8.7	Dead	Y
Self Weight (lb/ft)	-	14.43	14.43	0	8.7	Dead	Y

PASS

DATE:	3/24/2023	COMPANY:	Architects Northwest
STRUCALC BUILD:	StruCalc Plus	DESIGNED BY:	Sarah Weight
CUSTOMER:	Phan-Nguyen	REVIEWED BY:	Sarah Weight
PROJ. ADDRESS:	-- Mercer Island, WA	PROJECT NAME:	Phan-Nguyen
LEVEL:	StruCalc Members	LOADING:	ASD
MEMBER NAME:	U02 - LIV/DIN WDO HDR	CODE:	2018 International Building Code
MEMBER TYPE:	FLOOR BEAM	NDS:	2018 NDS
MATERIAL:	Glulams		
Stress Class Rated 24F-1.8E	24F-V4 DF/DF	(1) 5.125 X 12	DRY

U02 - LIV/DIN WDO HDR DIAGRAM

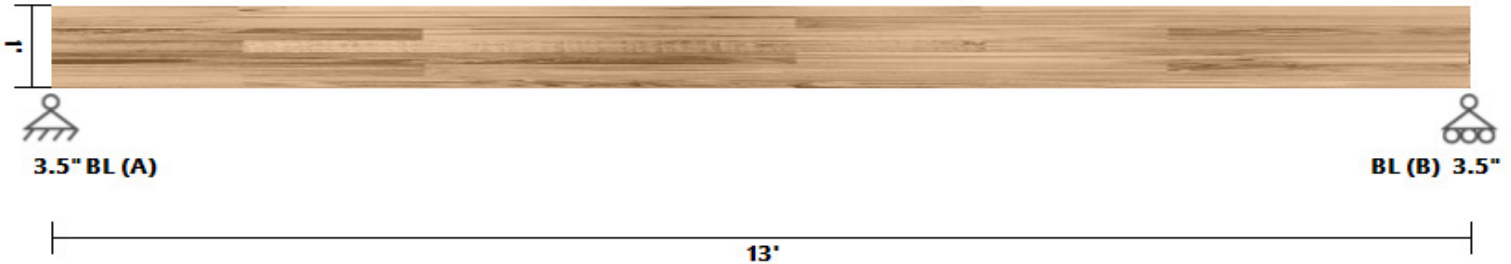

BEAM PROPERTIES

Start (ft): 0 End (ft): 13 Member Slope: 0/12 Actual Length (ft): 13

Area	Ix	Iy	BSW	Lams	G	Kcr
(in ²)	(in ⁴)	(in ⁴)	(lbf/ft)			Creep Factor
61.5	738	134.61	14.03	1	0.5	1

STRENGTH PROPERTIES

	Fbx+	Fbx-	Fby	Ft	Fvx	Fvy	Fc	Fc _⊥	Ex	Exmin	Ey	Eymin
	(psi)	(psi)	(psi)	(psi)	(psi)	(psi)	(psi)	(psi)	(psi)	(psi)	(psi)	(psi)
Base Values	2400	1850	1450	1100	265	230	1650	650	1800000	950000	1600000	850000
Adjusted Values	2400	1850	1450	1100	265	230	1650	650	1800000	950000	1600000	850000
C _M	1	1	1	1	1	1	1	1	1	1	1	1
C _T	1	1	1	1	1	1	1	1	1	1	1	1

Bending Adjustment Factors C_{Vr} = 1

BEAM DATA

Span	Length (ft)	Unbraced Length (ft)		Beam End					
		Top	Bottom	Elev. Diff (ft)	CL(Top)	CL(Bottom)	CL(Left)	CL(Right)	
1	13	2	13	0	1.00	0.99	1.00	1.00	

PASS-FAIL

	PASS/FAIL	MAGNITUDE	STRENGTH	LOCATION (ft)	LOAD COMBO	DURATION FACTOR CD
Shear Stress Y (psi)	PASS (55.9%)	116.8	265.0	0	D+L	1
Bending Stress Y (psi)	PASS (36.6%)	1518.0	2393.3	6.5	D+L	1
Deflection (in)	PASS (17.8%)	0.356 (=L/438)	0.433 (=L/360)	6.5	D+L	
Bearing Stress (psi)	PASS (52.3%)	266.9	560.0	0	D+L	1

REACTIONS

Units for V: lbf Units for M: lbf-ft

Y axis	DEAD	LIVE	TOTAL
A	1797	2990	4787
B	1797	2990	4787

Reaction Location



LOAD LIST

Type	Name	Left Magnitude	Right Magnitude	Load Start (ft)	Load End (ft)	Load Type	Direction
Trapezoidal (lb/ft)	Trapezoidal	460	460	0	13	Live	Y
Trapezoidal (lb/ft)	Trapezoidal	172.5	172.5	0	13	Dead	Y
Trapezoidal (lb/ft)	Trapezoidal	90	90	0	13	Dead	Y
Self Weight (lb/ft)	-	14.03	14.03	0	13	Dead	Y

PASS

DATE:	3/24/2023	COMPANY:	Architects Northwest
STRUCALC BUILD:	StruCalc Plus	DESIGNED BY:	Sarah Weight
CUSTOMER:	Phan-Nguyen	REVIEWED BY:	Sarah Weight
PROJ. ADDRESS:	-- Mercer Island, WA	PROJECT NAME:	Phan-Nguyen
LEVEL:	StruCalc Members	LOADING:	ASD
MEMBER NAME:	U02.OT1 - LIV/DIN WDO HDR	CODE:	2018 International Building Code
MEMBER TYPE:	FLOOR BEAM	NDS:	2018 NDS
MATERIAL:	Glulams		
Stress Class Rated 24F-1.8E	24F-V4 DF/DF	(1) 5.125 X 12	DRY

U02.OT1 - LIV/DIN WDO HDR DIAGRAM

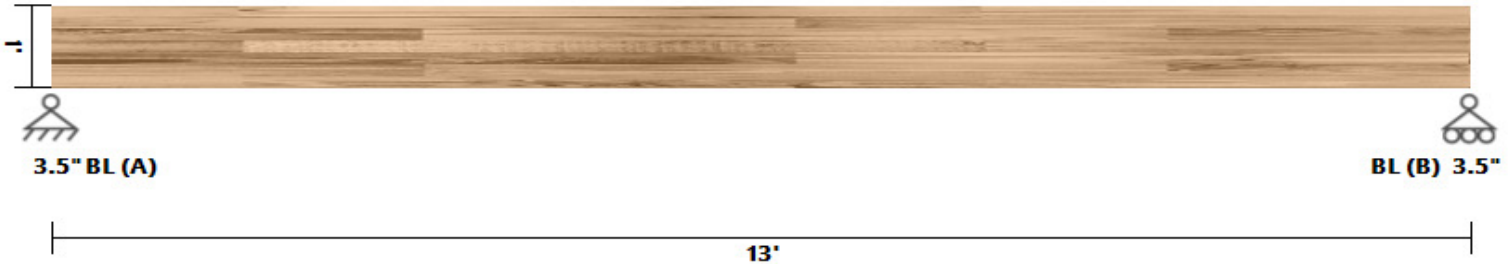

BEAM PROPERTIES

Start (ft): 0 End (ft): 13 Member Slope: 0/12 Actual Length (ft): 13

Area	Ix	Iy	BSW	Lams	G	Kcr
(in ²)	(in ⁴)	(in ⁴)	(lbf/ft)			Creep Factor
61.5	738	134.61	14.03	1	0.5	1

STRENGTH PROPERTIES

	Fbx+	Fbx-	Fby	Ft	Fvx	Fvy	Fc	Fc _⊥	Ex	Exmin	Ey	Eymin
	(psi)	(psi)	(psi)	(psi)	(psi)	(psi)	(psi)	(psi)	(psi)	(psi)	(psi)	(psi)
Base Values	2400	1850	1450	1100	265	230	1650	650	1800000	950000	1600000	850000
Adjusted Values	2400	1850	1450	1100	265	230	1650	650	1800000	950000	1600000	850000
C _M	1	1	1	1	1	1	1	1	1	1	1	1
C _T	1	1	1	1	1	1	1	1	1	1	1	1

Bending Adjustment Factors C_{Vr} = 1

BEAM DATA

Span	Length (ft)	Unbraced Length (ft)		Beam End					
		Top	Bottom	Elev. Diff (ft)	CL(Top)	CL(Bottom)	CL(Left)	CL(Right)	
1	13	2	13	0	1.00	0.99	1.00	1.00	

PASS-FAIL

	PASS/FAIL	MAGNITUDE	STRENGTH	LOCATION (ft)	LOAD COMBO	DURATION FACTOR CD
Shear Stress Y (psi)	PASS (38.6%)	162.8	265.0	0	D+L	1
Bending Stress Y (psi)	PASS (45.2%)	1311.6	2393.3	4.03	D+L	1
Deflection (in)	PASS (36.7%)	0.274 (=L/568)	0.433 (=L/360)	5.85	D+L	
Bearing Stress (psi)	PASS (33.5%)	372.2	560.0	0	D+L	1

REACTIONS

Units for V: lbf Units for M: lbf-ft

Y axis	DEAD	LIVE	TOTAL
A	2139	4538	6677
B	2139	-1548	591

Reaction Location



LOAD LIST

Type	Name	Left Magnitude	Right Magnitude	Load Start (ft)	Load End (ft)	Load Type	Direction
Trapezoidal (lbf/ft)	Trapezoidal	230	230	0	13	Live	Y
Trapezoidal (lbf/ft)	Trapezoidal	207	207	0	13	Dead	Y
Point (lbf)	Point	4395	-	2	-	Live	Y
Point (lbf)	Point	-4395	-	11	-	Live	Y
Trapezoidal (lbf/ft)	Trapezoidal	108	108	0	13	Dead	Y
Self Weight (lbf/ft)	-	14.03	14.03	0	13	Dead	Y

PASS

DATE:	3/24/2023	COMPANY:	Architects Northwest
STRUCALC BUILD:	StruCalc Plus	DESIGNED BY:	Sarah Weight
CUSTOMER:	Phan-Nguyen	REVIEWED BY:	Sarah Weight
PROJ. ADDRESS:	-- Mercer Island, WA	PROJECT NAME:	Phan-Nguyen
LEVEL:	StruCalc Members	LOADING:	ASD
MEMBER NAME:	U02.OT2 - LIV/DIN WDO HDR	CODE:	2018 International Building Code
MEMBER TYPE:	FLOOR BEAM	NDS:	2018 NDS
MATERIAL:	Glulams		
Stress Class Rated 24F-1.8E	24F-V4 DF/DF	(1) 5.125 X 12	DRY

U02.OT2 - LIV/DIN WDO HDR DIAGRAM

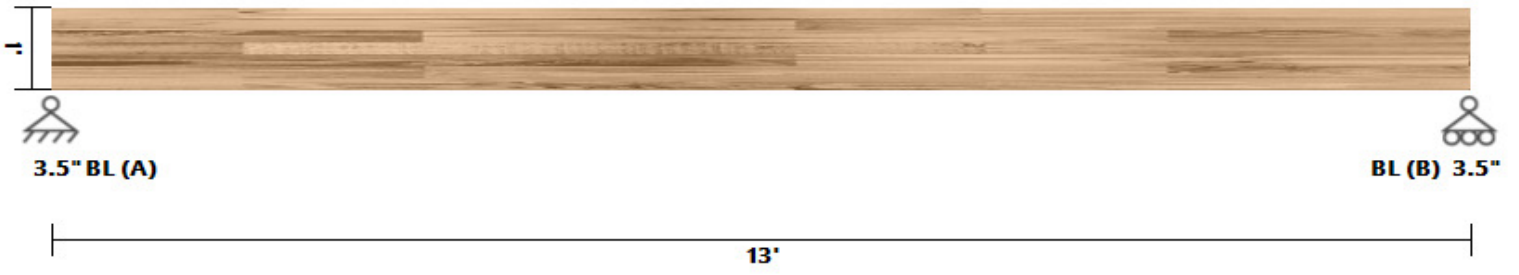

BEAM PROPERTIES

Start (ft): 0 End (ft): 13 Member Slope: 0/12 Actual Length (ft): 13

Area	Ix	Iy	BSW	Lams	G	Kcr
(in ²)	(in ⁴)	(in ⁴)	(lbf/ft)			Creep Factor
61.5	738	134.61	14.03	1	0.5	1

STRENGTH PROPERTIES

	Fbx+	Fbx-	Fby	Ft	Fvx	Fvy	Fc	Fc _⊥	Ex	Exmin	Ey	Eymin
	(psi)	(psi)	(psi)	(psi)	(psi)	(psi)	(psi)	(psi)	(psi)	(psi)	(psi)	(psi)
Base Values	2400	1850	1450	1100	265	230	1650	650	1800000	950000	1600000	850000
Adjusted Values	2400	1850	1450	1100	265	230	1650	650	1800000	950000	1600000	850000
C _M	1	1	1	1	1	1	1	1	1	1	1	1
C _T	1	1	1	1	1	1	1	1	1	1	1	1

Bending Adjustment Factors C_{Vr} = 1

BEAM DATA

Span	Length (ft)	Unbraced Length (ft)		Beam End					
		Top	Bottom	Elev. Diff (ft)	CL(Top)	CL(Bottom)	CL(Left)	CL(Right)	
1	13	2	13	0	1.00	0.99	1.00	1.00	

PASS-FAIL

	PASS/FAIL	MAGNITUDE	STRENGTH	LOCATION (ft)	LOAD COMBO	DURATION FACTOR CD
Shear Stress Y (psi)	PASS (38.6%)	162.8	265.0	13	D+L	1
Bending Stress Y (psi)	PASS (45.2%)	1311.6	2393.3	8.97	D+L	1
Deflection (in)	PASS (36.7%)	0.274 (=L/568)	0.433 (=L/360)	7.15	D+L	
Bearing Stress (psi)	PASS (33.5%)	372.2	560.0	13	D+L	1

REACTIONS

Units for V: lbf Units for M: lbf-ft

Y axis	DEAD	LIVE	TOTAL
A	2139	-1548	591
B	2139	4538	6677

Reaction Location



LOAD LIST

Type	Name	Left Magnitude	Right Magnitude	Load Start (ft)	Load End (ft)	Load Type	Direction
Trapezoidal (lbf/ft)	Trapezoidal	230	230	0	13	Live	Y
Trapezoidal (lbf/ft)	Trapezoidal	207	207	0	13	Dead	Y
Point (lbf)	Point	-4395	-	2	-	Live	Y
Point (lbf)	Point	4395	-	11	-	Live	Y
Trapezoidal (lbf/ft)	Trapezoidal	108	108	0	13	Dead	Y
Self Weight (lbf/ft)	-	14.03	14.03	0	13	Dead	Y

PASS

DATE:	3/24/2023	COMPANY:	Architects Northwest
STRUCALC BUILD:	StruCalc Plus	DESIGNED BY:	Sarah Weight
CUSTOMER:	Phan-Nguyen	REVIEWED BY:	Sarah Weight
PROJ. ADDRESS:	-- Mercer Island, WA	PROJECT NAME:	Phan-Nguyen
LEVEL:	StruCalc Members	LOADING:	ASD
MEMBER NAME:	U03 - BRIDGE BEAM	CODE:	2018 International Building Code
MEMBER TYPE:	FLOOR BEAM	NDS:	2018 NDS
MATERIAL:	Glulams		
Stress Class Rated 24F-1.8E	24F-V4 DF/DF	(1) 3.125 X 18	DRY

U03 - BRIDGE BEAM DIAGRAM

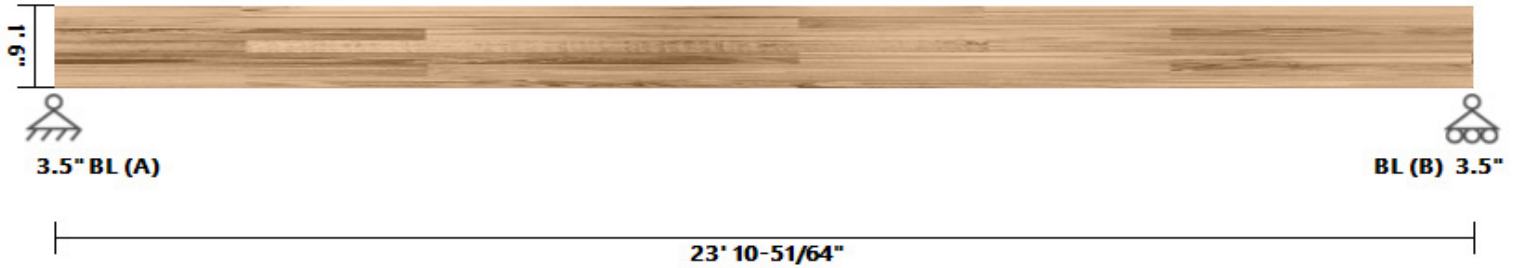

BEAM PROPERTIES

Start (ft): 0 End (ft): 23.9 Member Slope: 0/12 Actual Length (ft): 23.9

Area	Ix	Iy	BSW	Lams	G	Kcr
(in ²)	(in ⁴)	(in ⁴)	(lbf/ft)			Creep Factor
56.25	1518.75	45.78	12.83	1	0.5	1

STRENGTH PROPERTIES

	Fbx+	Fbx-	Fby	Ft	Fvx	Fvy	Fc	Fc _⊥	Ex	Exmin	Ey	Eymin
	(psi)	(psi)	(psi)	(psi)	(psi)	(psi)	(psi)	(psi)	(psi)	(psi)	(psi)	(psi)
Base Values	2400	1850	1450	1100	265	230	1650	650	1800000	950000	1600000	850000
Adjusted Values	2400	1850	1450	1100	265	230	1650	650	1800000	950000	1600000	850000
C _M	1	1	1	1	1	1	1	1	1	1	1	1
C _T	1	1	1	1	1	1	1	1	1	1	1	1

Bending Adjustment Factors C_{Vr} = 1

BEAM DATA

Span	Length (ft)	Unbraced Length (ft)		Beam End		CL(Left)	CL(Right)
		Top	Bottom	Elev. Diff (ft)	CL(Top)		
1	23.9	2	23.9	0	0.99	0.54	1.00

PASS-FAIL

	PASS/FAIL	MAGNITUDE	STRENGTH	LOCATION (ft)	LOAD COMBO	DURATION FACTOR CD
Shear Stress Y (psi)	PASS (77.7%)	59.2	265.0	0	D+L	1
Bending Stress Y (psi)	PASS (60.2%)	943.5	2368.2	11.95	D+L	1
Deflection (in)	PASS (37.4%)	0.499 (=L/575)	0.797 (=L/360)	11.95	D+L	
Bearing Stress (psi)	PASS (63.7%)	203.0	560.0	0	D+L	1

REACTIONS

Units for V: lbf Units for M: lbf-ft

Y axis	DEAD	LIVE	TOTAL
A	1265	956	2221
B	1265	956	2221



LOAD LIST

Type	Name	Left Magnitude	Right Magnitude	Load Start (ft)	Load End (ft)	Load Type	Direction
Trapezoidal (lb/ft)	Trapezoidal	80	80	0	23.9	Live	Y
Trapezoidal (lb/ft)	Trapezoidal	30	30	0	23.9	Dead	Y
Trapezoidal (lb/ft)	Trapezoidal	63	63	0	23.9	Dead	Y
Self Weight (lb/ft)	-	12.83	12.83	0	23.9	Dead	Y

DATE:	3/24/2023	COMPANY:	Architects Northwest
STRUCALC BUILD:	StruCalc Plus	DESIGNED BY:	Sarah Weight
CUSTOMER:	Phan-Nguyen	REVIEWED BY:	Sarah Weight
PROJ. ADDRESS:	-- Mercer Island, WA	PROJECT NAME:	Phan-Nguyen
LEVEL:	StruCalc Members	LOADING:	ASD
MEMBER NAME:	U04 - BRIDGE BEAM	CODE:	2018 International Building Code
MEMBER TYPE:	FLOOR BEAM	NDS:	2018 NDS
MATERIAL:	Glulams		
Stress Class Rated 24F-1.8E	24F-V4 DF/DF	(1) 3.125 X 16.5	DRY

U04 - BRIDGE BEAM DIAGRAM

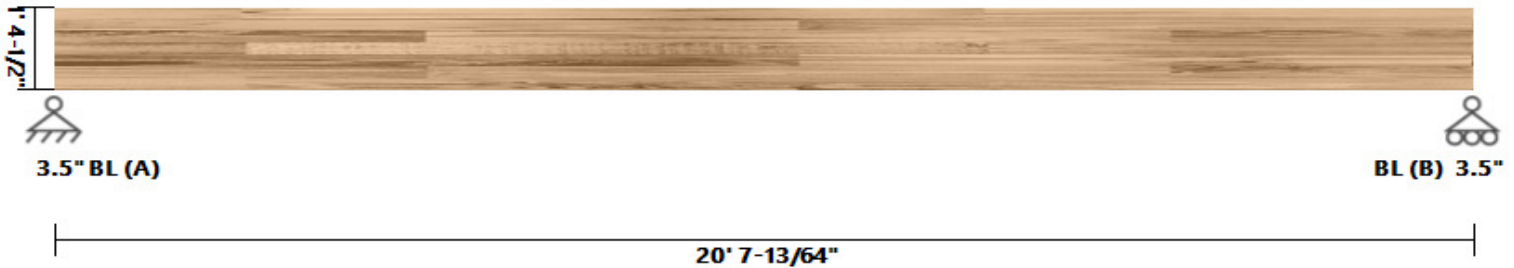

BEAM PROPERTIES

Start (ft): 0 End (ft): 20.6 Member Slope: 0/12 Actual Length (ft): 20.6

Area	Ix	Iy	BSW	Lams	G	Kcr
(in ²)	(in ⁴)	(in ⁴)	(lbf/ft)			Creep Factor
51.56	1169.82	41.96	11.76	1	0.5	1

STRENGTH PROPERTIES

	Fbx+	Fbx-	Fby	Ft	Fvx	Fvy	Fc	Fc _⊥	Ex	Exmin	Ey	Eymin
	(psi)	(psi)	(psi)	(psi)	(psi)	(psi)	(psi)	(psi)	(psi)	(psi)	(psi)	(psi)
Base Values	2400	1850	1450	1100	265	230	1650	650	1800000	950000	1600000	850000
Adjusted Values	2400	1850	1450	1100	265	230	1650	650	1800000	950000	1600000	850000
C _M	1	1	1	1	1	1	1	1	1	1	1	1
C _T	1	1	1	1	1	1	1	1	1	1	1	1
Bending Adjustment Factors	C _{Vr} = 1											

BEAM DATA

Span	Length (ft)	Unbraced Length (ft)		Beam End				
		Top	Bottom	Elev. Diff (ft)	CL(Top)	CL(Bottom)	CL(Left)	CL(Right)
1	20.6	2	20.6	0	0.99	0.71	1.00	1.00

PASS-FAIL

	PASS/FAIL	MAGNITUDE	STRENGTH	LOCATION (ft)	LOAD COMBO	DURATION FACTOR CD
Shear Stress Y (psi)	PASS (98.5%)	3.5	238.5	0	D	0.9
Bending Stress Y (psi)	PASS (97.5%)	52.8	2137.3	10.3	D	0.9
Deflection (in)	PASS (96.7%)	0.023 (=L/10939)	0.687 (=L/360)	10.3	D+L	
Bearing Stress (psi)	PASS (98.0%)	11.1	560.0	0	D	0.9

REACTIONS

Units for V: lbf Units for M: lbf-ft

Y axis	DEAD	TOTAL
A	121	121
B	121	121

Reaction Location

A

B

LOAD LIST

Type	Name	Left Magnitude	Right Magnitude	Load Start (ft)	Load End (ft)	Load Type	Direction
Self Weight (lbf/ft)	-	11.76	11.76	0	20.6	Dead	Y

PASS

DATE:	3/24/2023	COMPANY:	Architects Northwest
STRUCALC BUILD:	StruCalc Plus	DESIGNED BY:	Sarah Weight
CUSTOMER:	Phan-Nguyen	REVIEWED BY:	Sarah Weight
PROJ. ADDRESS:	-- Mercer Island, WA	PROJECT NAME:	Phan-Nguyen
LEVEL:	StruCalc Members	LOADING:	ASD
MEMBER NAME:	U05 - DINING BEAM	CODE:	2018 International Building Code
MEMBER TYPE:	FLOOR BEAM	NDS:	2018 NDS
MATERIAL:	Glulams		
Stress Class Rated 24F-1.8E	24F-V4 DF/DF	(1) 5.125 X 18	DRY

U05 - DINING BEAM DIAGRAM

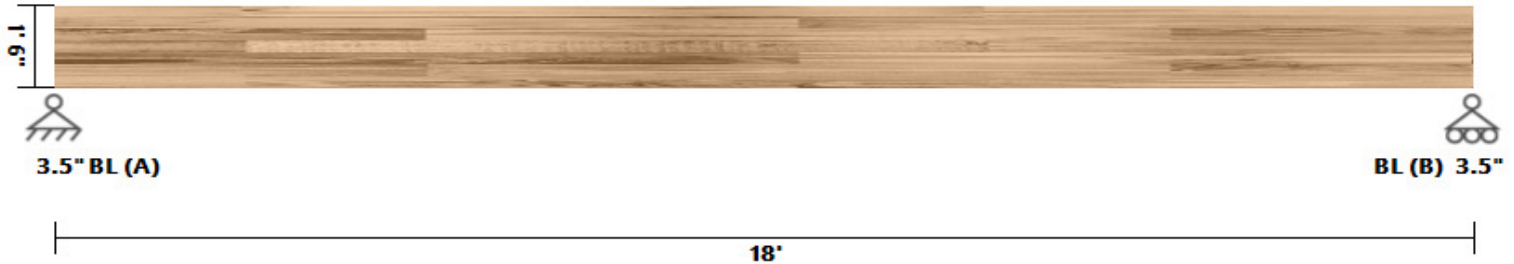

BEAM PROPERTIES

Start (ft): 0 End (ft): 18 Member Slope: 0/12 Actual Length (ft): 18

Area	Ix	Iy	BSW	Lams	G	Kcr
(in ²)	(in ⁴)	(in ⁴)	(lbf/ft)			Creep Factor
92.25	2490.75	201.92	21.04	1	0.5	1

STRENGTH PROPERTIES

	Fbx+	Fbx-	Fby	Ft	Fvx	Fvy	Fc	Fc _⊥	Ex	Exmin	Ey	Eymin
	(psi)	(psi)	(psi)	(psi)	(psi)	(psi)	(psi)	(psi)	(psi)	(psi)	(psi)	(psi)
Base Values	2400	1850	1450	1100	265	230	1650	650	1800000	950000	1600000	850000
Adjusted Values	2400	1850	1450	1100	265	230	1650	650	1800000	950000	1600000	850000
C _M	1	1	1	1	1	1	1	1	1	1	1	1
C _T	1	1	1	1	1	1	1	1	1	1	1	1

Bending Adjustment Factors C_{Vr} = 1

BEAM DATA

Span	Length (ft)	Unbraced Length (ft)		Beam End					
		Top	Bottom	Elev. Diff (ft)	CL(Top)	CL(Bottom)	CL(Left)	CL(Right)	
1	18	2	18	0	1.00	0.97	1.00	1.00	

PASS-FAIL

	PASS/FAIL	MAGNITUDE	STRENGTH	LOCATION (ft)	LOAD COMBO	DURATION FACTOR CD
Shear Stress Y (psi)	PASS (55.3%)	118.5	265.0	18	D+L	1
Bending Stress Y (psi)	PASS (39.2%)	1422.5	2340.4	9	D+L	1
Deflection (in)	PASS (28.9%)	0.427 (=L/506)	0.600 (=L/360)	9	D+L	
Bearing Stress (psi)	PASS (27.4%)	406.4	560.0	0	D+L	1

REACTIONS

Units for V: lbf Units for M: lbf-ft

Y axis	DEAD	LIVE	TOTAL
A	2538	4752	7290
B	2538	4752	7290

Reaction Location



LOAD LIST

Type	Name	Left Magnitude	Right Magnitude	Load Start (ft)	Load End (ft)	Load Type	Direction
Trapezoidal (lb/ft)	Trapezoidal	528	528	0	18	Live	Y
Trapezoidal (lb/ft)	Trapezoidal	198	198	0	18	Dead	Y
Trapezoidal (lb/ft)	Trapezoidal	63	63	0	18	Dead	Y
Self Weight (lb/ft)	-	21.04	21.04	0	18	Dead	Y

PASS

DATE:	3/24/2023	COMPANY:	Architects Northwest
STRUCALC BUILD:	StruCalc Plus	DESIGNED BY:	Sarah Weight
CUSTOMER:	Phan-Nguyen	REVIEWED BY:	Sarah Weight
PROJ. ADDRESS:	-- Mercer Island, WA	PROJECT NAME:	Phan-Nguyen
LEVEL:	StruCalc Members	LOADING:	ASD
MEMBER NAME:	U06 - DINING WDO HDR	CODE:	2018 International Building Code
MEMBER TYPE:	FLOOR BEAM	NDS:	2018 NDS
MATERIAL:	Glulams		
Stress Class Rated 24F-1.8E	24F-V4 DF/DF	(1) 5.125 X 16.5	DRY

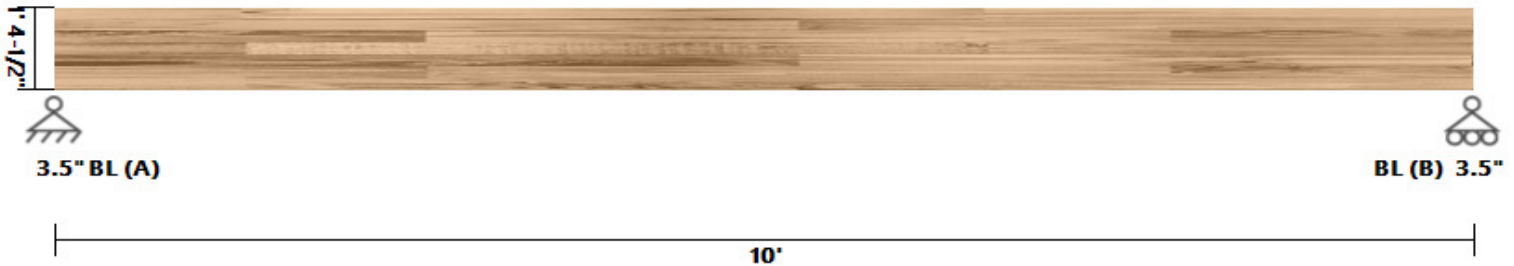
U06 - DINING WDO HDR DIAGRAM**BEAM PROPERTIES**

Start (ft): 0 End (ft): 10 Member Slope: 0/12 Actual Length (ft): 10

Area	Ix	Iy	BSW	Lams	G	Kcr
(in ²)	(in ⁴)	(in ⁴)	(lbf/ft)			Creep Factor
84.56	1918.51	185.09	19.29	1	0.5	1

STRENGTH PROPERTIES

	Fbx+	Fbx-	Fby	Ft	Fvx	Fvy	Fc	Fc _⊥	Ex	Exmin	Ey	Eymin
	(psi)	(psi)	(psi)	(psi)	(psi)	(psi)	(psi)	(psi)	(psi)	(psi)	(psi)	(psi)
Base Values	2400	1850	1450	1100	265	230	1650	650	1800000	950000	1600000	850000
Adjusted Values	2400	1850	1450	1100	265	230	1650	650	1800000	950000	1600000	850000
C _M	1	1	1	1	1	1	1	1	1	1	1	1
C _T	1	1	1	1	1	1	1	1	1	1	1	1
Bending Adjustment Factors	C _{Vr} = 1											

BEAM DATA

Span	Length (ft)	Unbraced Length (ft)		Beam End		CL(Left)	CL(Right)
		Top	Bottom	Elev. Diff (ft)	CL(Top)		
1	10	4	10	0	0.99	0.99	1.00

PASS-FAIL

	PASS/FAIL	MAGNITUDE	STRENGTH	LOCATION (ft)	LOAD COMBO	DURATION FACTOR CD
Shear Stress Y (psi)	PASS (71.9%)	74.4	265.0	10	D+L	1
Bending Stress Y (psi)	PASS (59.7%)	959.7	2379.8	5.5	D+L	1
Deflection (in)	PASS (76.7%)	0.078 (=L/1544)	0.333 (=L/360)	5.2	D+L	
Bearing Stress (psi)	PASS (51.2%)	273.4	560.0	0	D+L	1

REACTIONS

Units for V: lbf Units for M: lbf-ft

Y axis	DEAD	LIVE	LIVE ROOF	TOTAL
A	1872	3032	76	4980
B	1582	2613	118	4313

Reaction Location

A

B

LOAD LIST

Type	Name	Left Magnitude	Right Magnitude	Load Start (ft)	Load End (ft)	Load Type	Direction
Axial (lbf)	Axial	894	894	0	0	Live	Y
Axial (lbf)	Axial	576	576	0	0	Dead	Y
Self Weight (lbf/ft)	-	19.29	19.29	0	10	Dead	Y

LINKED LOAD LIST

Type	Left Magnitude	Right Magnitude	Load Start (ft)	Load End (ft)	Load Type	Direction
Point (lbf)	147.8356	-	6.1	-	Dead	Y
Point (lbf)	193.9154	-	6.1	-	RoofLive	Y
Point (lbf)	2538.355	-	5.5	-	Dead	Y
Point (lbf)	4752	-	5.5	-	Live	Y

PASS

DATE:	3/24/2023	COMPANY:	Architects Northwest
STRUCALC BUILD:	StruCalc Plus	DESIGNED BY:	Sarah Weight
CUSTOMER:	Phan-Nguyen	REVIEWED BY:	Sarah Weight
PROJ. ADDRESS:	-- Mercer Island, WA	PROJECT NAME:	Phan-Nguyen
LEVEL:	StruCalc Members	LOADING:	ASD
MEMBER NAME:	U06.OT1 - DINING WDO HDR	CODE:	2018 International Building Code
MEMBER TYPE:	FLOOR BEAM	NDS:	2018 NDS
MATERIAL:	Glulams		
Stress Class Rated 24F-1.8E	24F-V4 DF/DF	(1) 5.125 X 16.5	DRY

U06.OT1 - DINING WDO HDR DIAGRAM

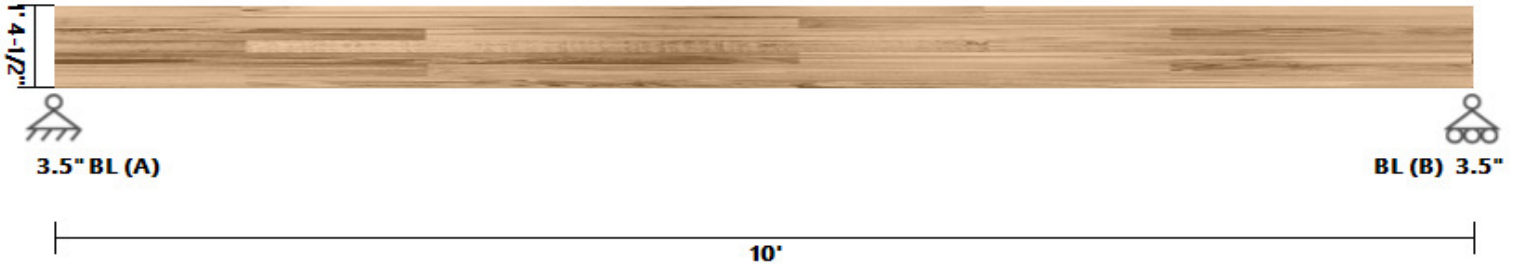

BEAM PROPERTIES

Start (ft): 0 End (ft): 10 Member Slope: 0/12 Actual Length (ft): 10

Area	Ix	Iy	BSW	Lams	G	Kcr
(in ²)	(in ⁴)	(in ⁴)	(lbf/ft)			Creep Factor
84.56	1918.51	185.09	19.29	1	0.5	1

STRENGTH PROPERTIES

	Fbx+	Fbx-	Fby	Ft	Fvx	Fvy	Fc	Fc _⊥	Ex	Exmin	Ey	Eymin
	(psi)	(psi)	(psi)	(psi)	(psi)	(psi)	(psi)	(psi)	(psi)	(psi)	(psi)	(psi)
Base Values	2400	1850	1450	1100	265	230	1650	650	1800000	950000	1600000	850000
Adjusted Values	2400	1850	1450	1100	265	230	1650	650	1800000	950000	1600000	850000
C _M	1	1	1	1	1	1	1	1	1	1	1	1
C _T	1	1	1	1	1	1	1	1	1	1	1	1

Bending Adjustment Factors C_{Vr} = 1

BEAM DATA

Span	Length (ft)	Unbraced Length (ft)		Beam End		CL(Left)	CL(Right)
		Top	Bottom	Elev. Diff (ft)	CL(Top)		
1	10	4	10	0	0.99	0.99	1.00

PASS-FAIL

	PASS/FAIL	MAGNITUDE	STRENGTH	LOCATION (ft)	LOAD COMBO	DURATION FACTOR CD
Shear Stress Y (psi)	PASS (99.3%)	1.7	238.5	0	D	0.9
Bending Stress Y (psi)	PASS (99.4%)	12.4	2143.9	5	D	0.9
Deflection (in)	PASS (99.6%)	0.001 (=L/92298)	0.333 (=L/360)	5	D+L	
Bearing Stress (psi)	PASS (99.0%)	5.4	560.0	0	D	0.9

REACTIONS

Units for V: lbf Units for M: lbf-ft

Y axis	DEAD	TOTAL
A	96	96
B	96	96

Reaction Location



LOAD LIST

Type	Name	Left Magnitude	Right Magnitude	Load Start (ft)	Load End (ft)	Load Type	Direction
Self Weight (lbf/ft)	-	19.29	19.29	0	10	Dead	Y

PASS

DATE:	3/24/2023	COMPANY:	Architects Northwest
STRUCALC BUILD:	StruCalc Plus	DESIGNED BY:	Sarah Weight
CUSTOMER:	Phan-Nguyen	REVIEWED BY:	Sarah Weight
PROJ. ADDRESS:	-- Mercer Island, WA	PROJECT NAME:	Phan-Nguyen
LEVEL:	StruCalc Members	LOADING:	ASD
MEMBER NAME:	U06.OT2 - DINING WDO HDR	CODE:	2018 International Building Code
MEMBER TYPE:	FLOOR BEAM	NDS:	2018 NDS
MATERIAL:	Glulams		
Stress Class Rated 24F-1.8E	24F-V4 DF/DF	(1) 5.125 X 16.5	DRY

U06.OT2 - DINING WDO HDR DIAGRAM

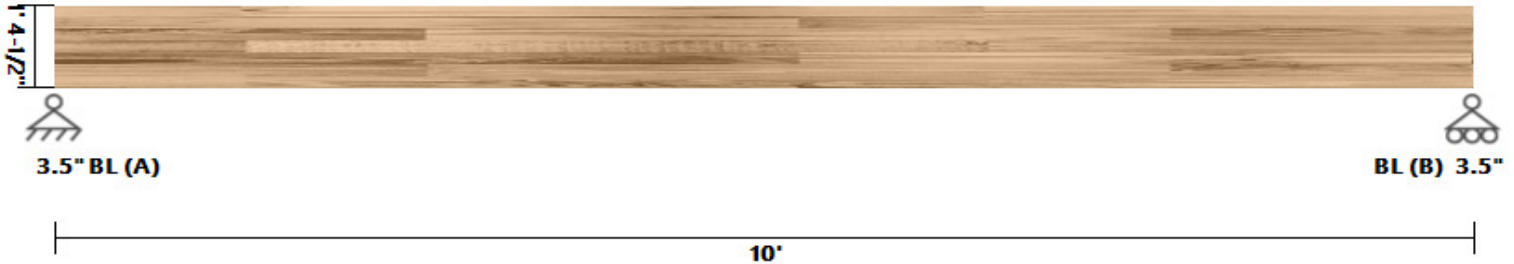

BEAM PROPERTIES

Start (ft): 0 End (ft): 10 Member Slope: 0/12 Actual Length (ft): 10

Area	Ix	Iy	BSW	Lams	G	Kcr
(in ²)	(in ⁴)	(in ⁴)	(lbf/ft)			Creep Factor
84.56	1918.51	185.09	19.29	1	0.5	1

STRENGTH PROPERTIES

	Fbx+	Fbx-	Fby	Ft	Fvx	Fvy	Fc	Fc _⊥	Ex	Exmin	Ey	Eymin
	(psi)	(psi)	(psi)	(psi)	(psi)	(psi)	(psi)	(psi)	(psi)	(psi)	(psi)	(psi)
Base Values	2400	1850	1450	1100	265	230	1650	650	1800000	950000	1600000	850000
Adjusted Values	2400	1850	1450	1100	265	230	1650	650	1800000	950000	1600000	850000
C _M	1	1	1	1	1	1	1	1	1	1	1	1
C _T	1	1	1	1	1	1	1	1	1	1	1	1

Bending Adjustment Factors C_{Vr} = 1

BEAM DATA

Span	Length (ft)	Unbraced Length (ft)		Beam End				
		Top	Bottom	Elev. Diff (ft)	CL(Top)	CL(Bottom)	CL(Left)	CL(Right)
1	10	4	10	0	0.99	0.99	1.00	1.00

PASS-FAIL

	PASS/FAIL	MAGNITUDE	STRENGTH	LOCATION (ft)	LOAD COMBO	DURATION FACTOR CD
Shear Stress Y (psi)	PASS (99.3%)	1.7	238.5	0	D	0.9
Bending Stress Y (psi)	PASS (99.4%)	12.4	2143.9	5	D	0.9
Deflection (in)	PASS (99.6%)	0.001 (=L/92298)	0.333 (=L/360)	5	D+L	
Bearing Stress (psi)	PASS (99.0%)	5.4	560.0	0	D	0.9

REACTIONS

Units for V: lbf Units for M: lbf-ft

Y axis	DEAD	TOTAL
A	96	96
B	96	96

Reaction Location



LOAD LIST

Type	Name	Left Magnitude	Right Magnitude	Load Start (ft)	Load End (ft)	Load Type	Direction
Self Weight (lbf/ft)	-	19.29	19.29	0	10	Dead	Y

DATE:	3/24/2023	COMPANY:	Architects Northwest
STRUCALC BUILD:	StruCalc Plus	DESIGNED BY:	Sarah Weight
CUSTOMER:	Phan-Nguyen	REVIEWED BY:	Sarah Weight
PROJ. ADDRESS:	-- Mercer Island, WA	PROJECT NAME:	Phan-Nguyen
LEVEL:	StruCalc Members	LOADING:	ASD
MEMBER NAME:	U07 - DINING SGD HDR	CODE:	2018 International Building Code
MEMBER TYPE:	FLOOR BEAM	NDS:	2018 NDS
MATERIAL:	Solid Sawn		
Douglas Fir-Larch	No. 2	(1) 5.5 X 11.5	DRY

U07 - DINING SGD HDR DIAGRAM

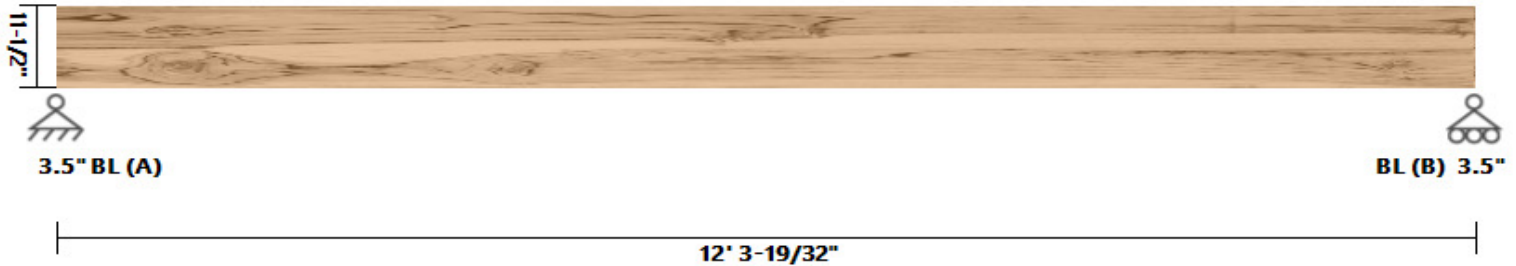

BEAM PROPERTIES

Start (ft): 0 End (ft): 12.3 Member Slope: 0/12 Actual Length (ft): 12.3

Area	I _x	I _y	BSW	Lams	G	K _{cr}
(in ²)	(in ⁴)	(in ⁴)	(lbf/ft)			Creep Factor
63.25	697.07	159.44	14.43	1	0.5	1

STRENGTH PROPERTIES

	F _b (psi)	F _t (psi)	F _v (psi)	F _c (psi)	F _{c⊥} (psi)	E (psi) x10 ³	E _{min} (psi) x10 ³
Base Values	875	425	170	600	625	1300	470
Adjusted Values	875	425	170	600	625	1300	470
C _M	1	1	1	1	1	1	1
C _T	1	1	1	1	1	1	1
C _i	1	1	1	1	1	1	1
C _F	1	1	1	1	1	1	1

Bending Adjustment Factors C_{fu} = 1 C_r = 1

BEAM DATA

Span	Length (ft)	Unbraced Length (ft)		Beam End				
		Top	Bottom	Elev. Diff (ft)	CL(Top)	CL(Bottom)	CL(Left)	CL(Right)
1	12.3	2	12.3	0	1.00	0.99	1.00	1.00

PASS-FAIL

	PASS/FAIL	MAGNITUDE	STRENGTH	LOCATION (ft)	LOAD COMBO	DURATION FACTOR CD
Shear Stress Y (psi)	PASS (66.0%)	57.8	170.0	0	D+L	1
Bending Stress Y (psi)	PASS (15.1%)	742.1	873.7	6.15	D+L	1
Deflection (in)	PASS (45.1%)	0.225 (=L/655)	0.410 (=L/360)	6.15	D+L	
Bearing Stress (psi)	PASS (79.7%)	126.7	625.0	0	D+L	1

REACTIONS

Units for V: lbf Units for M: lbf-ft

Y axis	DEAD	LIVE	TOTAL
A	1011	1427	2438
B	1011	1427	2438

Reaction Location

A

B

LOAD LIST

Type	Name	Left Magnitude	Right Magnitude	Load Start (ft)	Load End (ft)	Load Type	Direction
Trapezoidal (lb/ft)	Trapezoidal	232	232	0	12.3	Live	Y
Trapezoidal (lb/ft)	Trapezoidal	87	87	0	12.3	Dead	Y
Trapezoidal (lb/ft)	Trapezoidal	63	63	0	12.3	Dead	Y
Self Weight (lb/ft)	-	14.43	14.43	0	12.3	Dead	Y

PASS

DATE:	3/24/2023	COMPANY:	Architects Northwest
STRUCALC BUILD:	StruCalc Plus	DESIGNED BY:	Sarah Weight
CUSTOMER:	Phan-Nguyen	REVIEWED BY:	Sarah Weight
PROJ. ADDRESS:	-- Mercer Island, WA	PROJECT NAME:	Phan-Nguyen
LEVEL:	StruCalc Members	LOADING:	ASD
MEMBER NAME:	U08 - COV'D PATIO BEAM	CODE:	2018 International Building Code
MEMBER TYPE:	FLOOR BEAM	NDS:	2018 NDS
MATERIAL:	Glulams		
Stress Class Rated 24F-1.8E	24F-V4 DF/DF	(1) 5.125 X 13.5	DRY

U08 - COV'D PATIO BEAM DIAGRAM

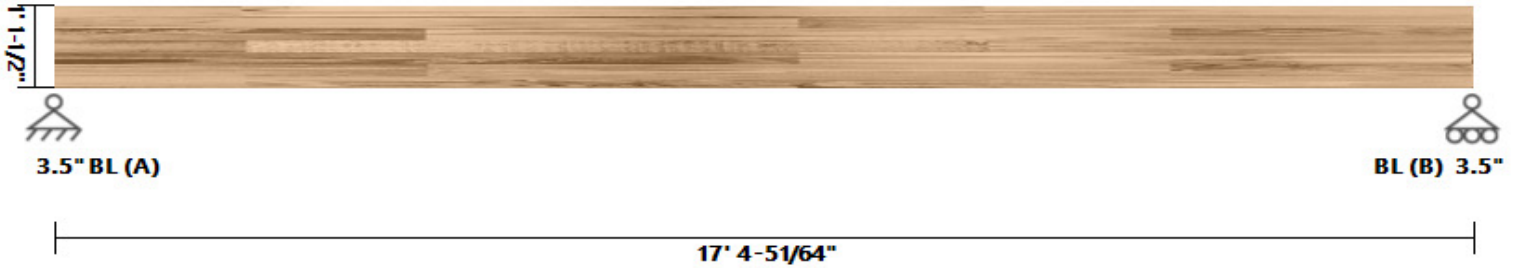

BEAM PROPERTIES

Start (ft): 0 End (ft): 17.4 Member Slope: 0/12 Actual Length (ft): 17.4

Area	Ix	Iy	BSW	Lams	G	Kcr
(in ²)	(in ⁴)	(in ⁴)	(lbf/ft)			Creep Factor
69.19	1050.79	151.44	15.78	1	0.5	1

STRENGTH PROPERTIES

	Fbx+	Fbx-	Fby	Ft	Fvx	Fvy	Fc	Fc _⊥	Ex	Exmin	Ey	Eymin
	(psi)	(psi)	(psi)	(psi)	(psi)	(psi)	(psi)	(psi)	(psi)	(psi)	(psi)	(psi)
Base Values	2400	1850	1450	1100	265	230	1650	650	1800000	950000	1600000	850000
Adjusted Values	2400	1850	1450	1100	265	230	1650	650	1800000	950000	1600000	850000
C _M	1	1	1	1	1	1	1	1	1	1	1	1
C _T	1	1	1	1	1	1	1	1	1	1	1	1

Bending Adjustment Factors C_{Vr} = 1

BEAM DATA

Span	Length (ft)	Unbraced Length (ft)		Beam End					
		Top	Bottom	Elev. Diff (ft)	CL(Top)	CL(Bottom)	CL(Left)	CL(Right)	
1	17.4	2	17.4	0	1.00	0.97	1.00	1.00	

PASS-FAIL

	PASS/FAIL	MAGNITUDE	STRENGTH	LOCATION (ft)	LOAD COMBO	DURATION FACTOR CD
Shear Stress Y (psi)	PASS (68.6%)	83.2	265.0	0	D+L	1
Bending Stress Y (psi)	PASS (46.2%)	1287.3	2392.4	8.7	D+L	1
Deflection (in)	PASS (17.0%)	0.481 (=L/434)	0.580 (=L/360)	8.7	D+L	
Bearing Stress (psi)	PASS (61.8%)	214.0	560.0	0	D+L	1

REACTIONS

Units for V: lbf Units for M: lbf-ft

Y axis	DEAD	LIVE	TOTAL
A	1316	2523	3839
B	1316	2523	3839

Reaction Location



LOAD LIST

Type	Name	Left Magnitude	Right Magnitude	Load Start (ft)	Load End (ft)	Load Type	Direction
Trapezoidal (lb/ft)	Trapezoidal	290	290	0	17.4	Live	Y
Trapezoidal (lb/ft)	Trapezoidal	72.5	72.5	0	17.4	Dead	Y
Trapezoidal (lb/ft)	Trapezoidal	63	63	0	17.4	Dead	Y
Self Weight (lb/ft)	-	15.78	15.78	0	17.4	Dead	Y

PASS

DATE:	3/24/2023	COMPANY:	Architects Northwest
STRUCALC BUILD:	StruCalc Plus	DESIGNED BY:	Sarah Weight
CUSTOMER:	Phan-Nguyen	REVIEWED BY:	Sarah Weight
PROJ. ADDRESS:	-- Mercer Island, WA	PROJECT NAME:	Phan-Nguyen
LEVEL:	StruCalc Members	LOADING:	ASD
MEMBER NAME:	U09 - COV'D DECK BEAM	CODE:	2018 International Building Code
MEMBER TYPE:	FLOOR BEAM	NDS:	2018 NDS
MATERIAL:	Glulams		
Stress Class Rated 24F-1.8E	24F-V4 DF/DF	(1) 5.125 X 15	DRY

U09 - COV'D DECK BEAM DIAGRAM



BEAM PROPERTIES

Start (ft): 0 End (ft): 18 Member Slope: 0/12 Actual Length (ft): 18

Area	Ix	Iy	BSW	Lams	G	Kcr
(in ²)	(in ⁴)	(in ⁴)	(lbf/ft)			Creep Factor
76.88	1441.41	168.26	17.53	1	0.5	1

STRENGTH PROPERTIES

	Fbx+	Fbx-	Fby	Ft	Fvx	Fvy	Fc	Fc _⊥	Ex	Exmin	Ey	Eymin
	(psi)	(psi)	(psi)	(psi)	(psi)	(psi)	(psi)	(psi)	(psi)	(psi)	(psi)	(psi)
Base Values	2400	1850	1450	1100	265	230	1650	650	1800000	950000	1600000	850000
Adjusted Values	2400	1850	1450	1100	265	230	1650	650	1800000	950000	1600000	850000
C _M	1	1	1	1	1	1	1	1	1	1	1	1
C _T	1	1	1	1	1	1	1	1	1	1	1	1

Bending Adjustment Factors C_{Vr} = 1

BEAM DATA

Span	Length (ft)	Unbraced Length (ft)		Beam End					
		Top	Bottom	Elev. Diff (ft)	CL(Top)	CL(Bottom)	CL(Left)	CL(Right)	
1	18	2	18	0	1.00	0.97	1.00	1.00	

PASS-FAIL

	PASS/FAIL	MAGNITUDE	STRENGTH	LOCATION (ft)	LOAD COMBO	DURATION FACTOR CD
Shear Stress Y (psi)	PASS (76.3%)	62.7	265.0	18	D+L	1
Bending Stress Y (psi)	PASS (62.1%)	902.9	2383.5	9	D+L	1
Deflection (in)	PASS (40.7%)	0.356 (=L/607)	0.600 (=L/360)	9	D+Lr	
Bearing Stress (psi)	PASS (60.5%)	221.0	560.0	0	D+0.75L+0.75Lr	1.25

REACTIONS

Units for V: lbf Units for M: lbf-ft

Y axis	DEAD	LIVE	LIVE ROOF	TOTAL
A	2169	1044	1350	4563
B	2169	1044	1350	4563

Reaction Location



LOAD LIST

Type	Name	Left Magnitude	Right Magnitude	Load Start (ft)	Load End (ft)	Load Type	Direction
Trapezoidal (lb/ft)	Trapezoidal	90	90	0	18	Dead	Y
Trapezoidal (lb/ft)	Trapezoidal	150	150	0	18	RoofLive	Y
Trapezoidal (lb/ft)	Trapezoidal	90	90	0	18	Dead	Y
Trapezoidal (lb/ft)	Trapezoidal	116	116	0	18	Live	Y
Trapezoidal (lb/ft)	Trapezoidal	43.5	43.5	0	18	Dead	Y
Self Weight (lb/ft)	-	17.53	17.53	0	18	Dead	Y

PASS

DATE:	3/24/2023	COMPANY:	Architects Northwest
STRUCALC BUILD:	StruCalc Plus	DESIGNED BY:	Sarah Weight
CUSTOMER:	Phan-Nguyen	REVIEWED BY:	Sarah Weight
PROJ. ADDRESS:	-- Mercer Island, WA	PROJECT NAME:	Phan-Nguyen
LEVEL:	StruCalc Members	LOADING:	ASD
MEMBER NAME:	U10 - COV'D PATIO SIDE BEAM	CODE:	2018 International Building Code
MEMBER TYPE:	FLOOR BEAM	NDS:	2018 NDS
MATERIAL:	Glulams		
Stress Class Rated 24F-1.8E	24F-V4 DF/DF	(1) 5.125 X 13.5	DRY

U10 - COV'D PATIO SIDE BEAM DIAGRAM

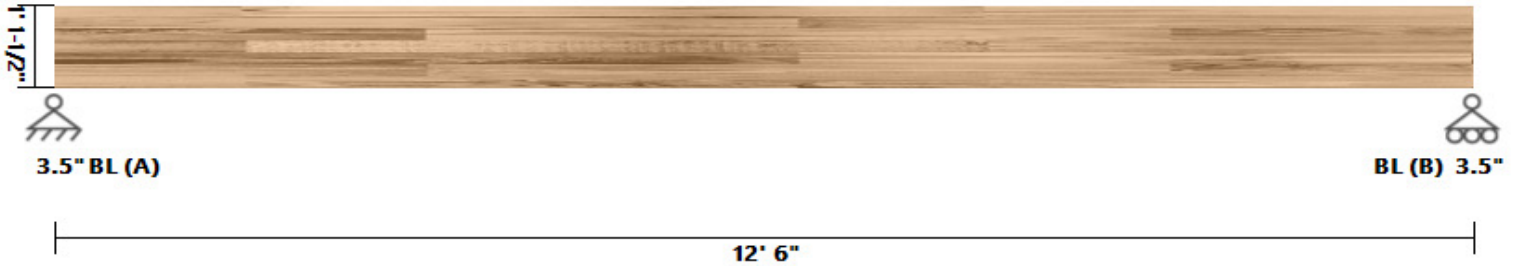

BEAM PROPERTIES

Start (ft): 0 End (ft): 12.5 Member Slope: 0/12 Actual Length (ft): 12.5

Area	Ix	Iy	BSW	Lams	G	Kcr
(in ²)	(in ⁴)	(in ⁴)	(lbf/ft)			Creep Factor
69.19	1050.79	151.44	15.78	1	0.5	1

STRENGTH PROPERTIES

	Fbx+	Fbx-	Fby	Ft	Fvx	Fvy	Fc	Fc _⊥	Ex	Exmin	Ey	Eymin
	(psi)	(psi)	(psi)	(psi)	(psi)	(psi)	(psi)	(psi)	(psi)	(psi)	(psi)	(psi)
Base Values	2400	1850	1450	1100	265	230	1650	650	1800000	950000	1600000	850000
Adjusted Values	2400	1850	1450	1100	265	230	1650	650	1800000	950000	1600000	850000
C _M	1	1	1	1	1	1	1	1	1	1	1	1
C _T	1	1	1	1	1	1	1	1	1	1	1	1

Bending Adjustment Factors C_{Vr} = 1

BEAM DATA

Span	Length (ft)	Unbraced Length (ft)		Beam End		CL(Left)	CL(Right)
		Top	Bottom	Elev. Diff (ft)	CL(Top)		
1	12.5	4	12.5	0	0.99	0.99	1.00

PASS-FAIL

	PASS/FAIL	MAGNITUDE	STRENGTH	LOCATION (ft)	LOAD COMBO	DURATION FACTOR CD
Shear Stress Y (psi)	PASS (82.8%)	45.5	265.0	12.5	D+L	1
Bending Stress Y (psi)	PASS (60.2%)	948.8	2383.9	6.5	D+L	1
Deflection (in)	PASS (64.6%)	0.147 (=L/1018)	0.417 (=L/360)	6.38	D+L	
Bearing Stress (psi)	PASS (72.4%)	154.5	560.0	0	D+L	1

REACTIONS

Units for V: lbf Units for M: lbf-ft

Y axis	DEAD	LIVE	TOTAL
A	1064	1707	2771
B	787	1312	2099

Reaction Location



LOAD LIST

Type	Name	Left Magnitude	Right Magnitude	Load Start (ft)	Load End (ft)	Load Type	Direction
Axial (lbf)	Axial	496	496	0	0	Live	Y
Axial (lbf)	Axial	327	327	0	0	Dead	Y
Self Weight (lbf/ft)	-	15.78	15.78	0	12.5	Dead	Y

LINKED LOAD LIST

Type	Left Magnitude	Right Magnitude	Load Start (ft)	Load End (ft)	Load Type	Direction
Point (lbf)	10.77632	-	4.5	-	Dead	Y
Point (lbf)	1316.133	-	6.5	-	Dead	Y
Point (lbf)	2523	-	6.5	-	Live	Y

PASS

DATE:	3/24/2023	COMPANY:	Architects Northwest
STRUCALC BUILD:	StruCalc Plus	DESIGNED BY:	Sarah Weight
CUSTOMER:	Phan-Nguyen	REVIEWED BY:	Sarah Weight
PROJ. ADDRESS:	-- Mercer Island, WA	PROJECT NAME:	Phan-Nguyen
LEVEL:	StruCalc Members	LOADING:	ASD
MEMBER NAME:	U10.OT1 - COV'D PATIO SIDE BEAM	CODE:	2018 International Building Code
MEMBER TYPE:	FLOOR BEAM	NDS:	2018 NDS
MATERIAL:	Glulams		
Stress Class Rated 24F-1.8E	24F-V4 DF/DF	(1) 5.125 X 13.5	DRY

U10.OT1 - COV'D PATIO SIDE BEAM DIAGRAM



BEAM PROPERTIES

Start (ft): 0 End (ft): 12.5 Member Slope: 0/12 Actual Length (ft): 12.5

Area	Ix	Iy	BSW	Lams	G	Kcr
(in ²)	(in ⁴)	(in ⁴)	(lbf/ft)			Creep Factor
69.19	1050.79	151.44	15.78	1	0.5	1

STRENGTH PROPERTIES

	Fbx+	Fbx-	Fby	Ft	Fvx	Fvy	Fc	Fc _⊥	Ex	Exmin	Ey	Eymin
	(psi)	(psi)	(psi)	(psi)	(psi)	(psi)	(psi)	(psi)	(psi)	(psi)	(psi)	(psi)
Base Values	2400	1850	1450	1100	265	230	1650	650	1800000	950000	1600000	850000
Adjusted Values	2400	1850	1450	1100	265	230	1650	650	1800000	950000	1600000	850000
C _M	1	1	1	1	1	1	1	1	1	1	1	1
C _T	1	1	1	1	1	1	1	1	1	1	1	1

Bending Adjustment Factors C_{Vr} = 1

BEAM DATA

Span	Length (ft)	Unbraced Length (ft)		Beam End				
		Top	Bottom	Elev. Diff (ft)	CL(Top)	CL(Bottom)	CL(Left)	CL(Right)
1	12.5	4	12.5	0	0.99	0.99	1.00	1.00

PASS-FAIL

	PASS/FAIL	MAGNITUDE	STRENGTH	LOCATION (ft)	LOAD COMBO	DURATION FACTOR CD
Shear Stress Y (psi)	PASS (99.1%)	2.1	238.5	0	D	0.9
Bending Stress Y (psi)	PASS (98.9%)	23.8	2147.1	6.25	D	0.9
Deflection (in)	PASS (98.9%)	0.005 (=L/32611)	0.417 (=L/360)	6.25	D+L	
Bearing Stress (psi)	PASS (99.0%)	5.5	560.0	0	D	0.9

REACTIONS

Units for V: lbf Units for M: lbf-ft

Y axis	DEAD	TOTAL
A	99	99
B	99	99

Reaction Location



LOAD LIST

Type	Name	Left Magnitude	Right Magnitude	Load Start (ft)	Load End (ft)	Load Type	Direction
Self Weight (lbf/ft)	-	15.78	15.78	0	12.5	Dead	Y

PASS

DATE:	3/24/2023	COMPANY:	Architects Northwest
STRUCALC BUILD:	StruCalc Plus	DESIGNED BY:	Sarah Weight
CUSTOMER:	Phan-Nguyen	REVIEWED BY:	Sarah Weight
PROJ. ADDRESS:	-- Mercer Island, WA	PROJECT NAME:	Phan-Nguyen
LEVEL:	StruCalc Members	LOADING:	ASD
MEMBER NAME:	U10.OT2 - COV'D PATIO SIDE BEAM	CODE:	2018 International Building Code
MEMBER TYPE:	FLOOR BEAM	NDS:	2018 NDS
MATERIAL:	Glulams		
Stress Class Rated 24F-1.8E	24F-V4 DF/DF	(1) 5.125 X 13.5	DRY

U10.OT2 - COV'D PATIO SIDE BEAM DIAGRAM

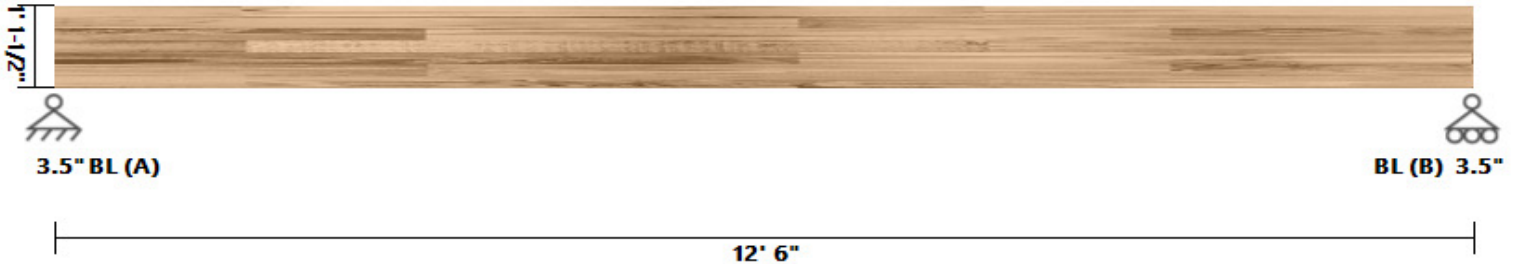

BEAM PROPERTIES

Start (ft): 0 End (ft): 12.5 Member Slope: 0/12 Actual Length (ft): 12.5

Area	Ix	Iy	BSW	Lams	G	Kcr
(in ²)	(in ⁴)	(in ⁴)	(lbf/ft)			Creep Factor
69.19	1050.79	151.44	15.78	1	0.5	1

STRENGTH PROPERTIES

	Fbx+	Fbx-	Fby	Ft	Fvx	Fvy	Fc	Fc _⊥	Ex	Exmin	Ey	Eymin
	(psi)	(psi)	(psi)	(psi)	(psi)	(psi)	(psi)	(psi)	(psi)	(psi)	(psi)	(psi)
Base Values	2400	1850	1450	1100	265	230	1650	650	1800000	950000	1600000	850000
Adjusted Values	2400	1850	1450	1100	265	230	1650	650	1800000	950000	1600000	850000
C _M	1	1	1	1	1	1	1	1	1	1	1	1
C _T	1	1	1	1	1	1	1	1	1	1	1	1

Bending Adjustment Factors C_{Vr} = 1

BEAM DATA

Span	Length (ft)	Unbraced Length (ft)		Beam End				
		Top	Bottom	Elev. Diff (ft)	CL(Top)	CL(Bottom)	CL(Left)	CL(Right)
1	12.5	4	12.5	0	0.99	0.99	1.00	1.00

PASS-FAIL

	PASS/FAIL	MAGNITUDE	STRENGTH	LOCATION (ft)	LOAD COMBO	DURATION FACTOR CD
Shear Stress Y (psi)	PASS (99.1%)	2.1	238.5	0	D	0.9
Bending Stress Y (psi)	PASS (98.9%)	23.8	2147.1	6.25	D	0.9
Deflection (in)	PASS (98.9%)	0.005 (=L/32611)	0.417 (=L/360)	6.25	D+L	
Bearing Stress (psi)	PASS (99.0%)	5.5	560.0	0	D	0.9

REACTIONS

Units for V: lbf Units for M: lbf-ft

Y axis	DEAD	TOTAL
A	99	99
B	99	99

Reaction Location



LOAD LIST

Type	Name	Left Magnitude	Right Magnitude	Load Start (ft)	Load End (ft)	Load Type	Direction
Self Weight (lbf/ft)	-	15.78	15.78	0	12.5	Dead	Y

PASS

DATE:	3/24/2023	COMPANY:	Architects Northwest
STRUCALC BUILD:	StruCalc Plus	DESIGNED BY:	Sarah Weight
CUSTOMER:	Phan-Nguyen	REVIEWED BY:	Sarah Weight
PROJ. ADDRESS:	-- Mercer Island, WA	PROJECT NAME:	Phan-Nguyen
LEVEL:	StruCalc Members	LOADING:	ASD
MEMBER NAME:	U11 - COV'D PATIO SIDE BEAM	CODE:	2018 International Building Code
MEMBER TYPE:	FLOOR BEAM	NDS:	2018 NDS
MATERIAL:	Glulams		
Stress Class Rated 24F-1.8E	24F-V4 DF/DF	(1) 5.125 X 13.5	DRY

U11 - COV'D PATIO SIDE BEAM DIAGRAM

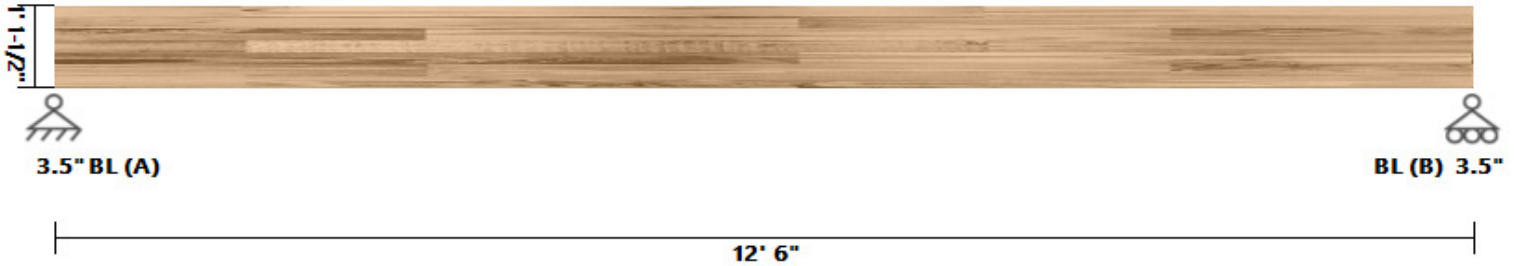

BEAM PROPERTIES

Start (ft): 0 End (ft): 12.5 Member Slope: 0/12 Actual Length (ft): 12.5

Area	Ix	Iy	BSW	Lams	G	Kcr
(in ²)	(in ⁴)	(in ⁴)	(lbf/ft)			Creep Factor
69.19	1050.79	151.44	15.78	1	0.5	1

STRENGTH PROPERTIES

	Fbx+	Fbx-	Fby	Ft	Fvx	Fvy	Fc	Fc _⊥	Ex	Exmin	Ey	Eymin
	(psi)	(psi)	(psi)	(psi)	(psi)	(psi)	(psi)	(psi)	(psi)	(psi)	(psi)	(psi)
Base Values	2400	1850	1450	1100	265	230	1650	650	1800000	950000	1600000	850000
Adjusted Values	2400	1850	1450	1100	265	230	1650	650	1800000	950000	1600000	850000
C _M	1	1	1	1	1	1	1	1	1	1	1	1
C _T	1	1	1	1	1	1	1	1	1	1	1	1

Bending Adjustment Factors C_{Vr} = 1

BEAM DATA

Span	Length (ft)	Unbraced Length (ft)		Beam End		CL(Left)	CL(Right)
		Top	Bottom	Elev. Diff (ft)	CL(Top)		
1	12.5	4	12.5	0	0.99	0.99	1.00

PASS-FAIL

	PASS/FAIL	MAGNITUDE	STRENGTH	LOCATION (ft)	LOAD COMBO	DURATION FACTOR CD
Shear Stress Y (psi)	PASS (82.8%)	45.5	265.0	12.5	D+L	1
Bending Stress Y (psi)	PASS (60.2%)	948.8	2383.9	6.5	D+L	1
Deflection (in)	PASS (64.6%)	0.147 (=L/1018)	0.417 (=L/360)	6.38	D+L	
Bearing Stress (psi)	PASS (72.4%)	154.5	560.0	0	D+L	1

REACTIONS

Units for V: lbf Units for M: lbf-ft

Y axis	DEAD	LIVE	TOTAL
A	1064	1707	2771
B	787	1312	2099

Reaction Location



LOAD LIST

Type	Name	Left Magnitude	Right Magnitude	Load Start (ft)	Load End (ft)	Load Type	Direction
Axial (lbf)	Axial	496	496	0	0	Live	Y
Axial (lbf)	Axial	327	327	0	0	Dead	Y
Self Weight (lbf/ft)	-	15.78	15.78	0	12.5	Dead	Y

LINKED LOAD LIST

Type	Left Magnitude	Right Magnitude	Load Start (ft)	Load End (ft)	Load Type	Direction
Point (lbf)	10.77632	-	4.5	-	Dead	Y
Point (lbf)	1316.133	-	6.5	-	Dead	Y
Point (lbf)	2523	-	6.5	-	Live	Y

PASS

DATE:	3/24/2023	COMPANY:	Architects Northwest
STRUCALC BUILD:	StruCalc Plus	DESIGNED BY:	Sarah Weight
CUSTOMER:	Phan-Nguyen	REVIEWED BY:	Sarah Weight
PROJ. ADDRESS:	-- Mercer Island, WA	PROJECT NAME:	Phan-Nguyen
LEVEL:	StruCalc Members	LOADING:	ASD
MEMBER NAME:	U11.OT1 - COV'D PATIO SIDE BEAM	CODE:	2018 International Building Code
MEMBER TYPE:	FLOOR BEAM	NDS:	2018 NDS
MATERIAL:	Glulams		
Stress Class Rated 24F-1.8E	24F-V4 DF/DF	(1) 5.125 X 13.5	DRY

U11.OT1 - COV'D PATIO SIDE BEAM DIAGRAM

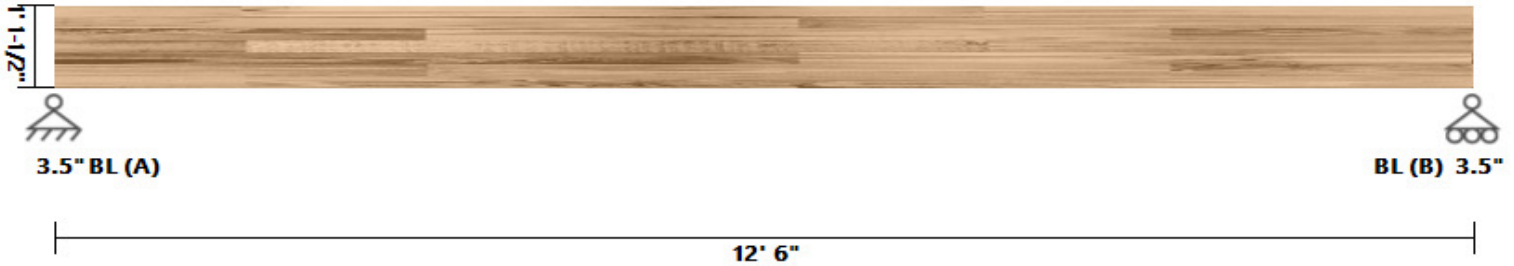

BEAM PROPERTIES

Start (ft): 0 End (ft): 12.5 Member Slope: 0/12 Actual Length (ft): 12.5

Area	Ix	Iy	BSW	Lams	G	Kcr
(in ²)	(in ⁴)	(in ⁴)	(lbf/ft)			Creep Factor
69.19	1050.79	151.44	15.78	1	0.5	1

STRENGTH PROPERTIES

	Fbx+	Fbx-	Fby	Ft	Fvx	Fvy	Fc	Fc _⊥	Ex	Exmin	Ey	Eymin
	(psi)	(psi)	(psi)	(psi)	(psi)	(psi)	(psi)	(psi)	(psi)	(psi)	(psi)	(psi)
Base Values	2400	1850	1450	1100	265	230	1650	650	1800000	950000	1600000	850000
Adjusted Values	2400	1850	1450	1100	265	230	1650	650	1800000	950000	1600000	850000
C _M	1	1	1	1	1	1	1	1	1	1	1	1
C _T	1	1	1	1	1	1	1	1	1	1	1	1
Bending Adjustment Factors	C _{Vr} = 1											

BEAM DATA

Span	Length (ft)	Unbraced Length (ft)		Beam End		CL(Top)	CL(Bottom)	CL(Left)	CL(Right)
		Top	Bottom	Elev. Diff (ft)					
1	12.5	4	12.5	0		0.99	0.99	1.00	1.00

PASS-FAIL

	PASS/FAIL	MAGNITUDE	STRENGTH	LOCATION (ft)	LOAD COMBO	DURATION FACTOR CD
Shear Stress Y (psi)	PASS (99.1%)	2.1	238.5	0	D	0.9
Bending Stress Y (psi)	PASS (98.9%)	23.8	2147.1	6.25	D	0.9
Deflection (in)	PASS (98.9%)	0.005 (=L/32611)	0.417 (=L/360)	6.25	D+L	
Bearing Stress (psi)	PASS (99.0%)	5.5	560.0	0	D	0.9

REACTIONS

Units for V: lbf Units for M: lbf-ft

Y axis	DEAD	TOTAL
A	99	99
B	99	99

Reaction Location



LOAD LIST

Type	Name	Left Magnitude	Right Magnitude	Load Start (ft)	Load End (ft)	Load Type	Direction
Self Weight (lbf/ft)	-	15.78	15.78	0	12.5	Dead	Y

PASS

DATE:	3/24/2023	COMPANY:	Architects Northwest
STRUCALC BUILD:	StruCalc Plus	DESIGNED BY:	Sarah Weight
CUSTOMER:	Phan-Nguyen	REVIEWED BY:	Sarah Weight
PROJ. ADDRESS:	-- Mercer Island, WA	PROJECT NAME:	Phan-Nguyen
LEVEL:	StruCalc Members	LOADING:	ASD
MEMBER NAME:	U11.OT2 - COV'D PATIO SIDE BEAM	CODE:	2018 International Building Code
MEMBER TYPE:	FLOOR BEAM	NDS:	2018 NDS
MATERIAL:	Glulams		
Stress Class Rated 24F-1.8E	24F-V4 DF/DF	(1) 5.125 X 13.5	DRY

U11.OT2 - COV'D PATIO SIDE BEAM DIAGRAM



BEAM PROPERTIES

Start (ft): 0 End (ft): 12.5 Member Slope: 0/12 Actual Length (ft): 12.5

Area	Ix	Iy	BSW	Lams	G	Kcr
(in ²)	(in ⁴)	(in ⁴)	(lbf/ft)			Creep Factor
69.19	1050.79	151.44	15.78	1	0.5	1

STRENGTH PROPERTIES

	Fbx+	Fbx-	Fby	Ft	Fvx	Fvy	Fc	Fc _⊥	Ex	Exmin	Ey	Eymin
	(psi)	(psi)	(psi)	(psi)	(psi)	(psi)	(psi)	(psi)	(psi)	(psi)	(psi)	(psi)
Base Values	2400	1850	1450	1100	265	230	1650	650	1800000	950000	1600000	850000
Adjusted Values	2400	1850	1450	1100	265	230	1650	650	1800000	950000	1600000	850000
C _M	1	1	1	1	1	1	1	1	1	1	1	1
C _T	1	1	1	1	1	1	1	1	1	1	1	1
Bending Adjustment Factors	C _{Vr} = 1											

BEAM DATA

Span	Length (ft)	Unbraced Length (ft)		Beam End				
		Top	Bottom	Elev. Diff (ft)	CL(Top)	CL(Bottom)	CL(Left)	CL(Right)
1	12.5	4	12.5	0	0.99	0.99	1.00	1.00

PASS-FAIL

	PASS/FAIL	MAGNITUDE	STRENGTH	LOCATION (ft)	LOAD COMBO	DURATION FACTOR CD
Shear Stress Y (psi)	PASS (99.1%)	2.1	238.5	0	D	0.9
Bending Stress Y (psi)	PASS (98.9%)	23.8	2147.1	6.25	D	0.9
Deflection (in)	PASS (98.9%)	0.005 (=L/32611)	0.417 (=L/360)	6.25	D+L	
Bearing Stress (psi)	PASS (99.0%)	5.5	560.0	0	D	0.9

REACTIONS

Units for V: lbf Units for M: lbf-ft

Y axis	DEAD	TOTAL
A	99	99
B	99	99

Reaction Location



LOAD LIST

Type	Name	Left Magnitude	Right Magnitude	Load Start (ft)	Load End (ft)	Load Type	Direction
Self Weight (lbf/ft)	-	15.78	15.78	0	12.5	Dead	Y

DATE:	3/24/2023	COMPANY:	Architects Northwest
STRUCALC BUILD:	StruCalc Plus	DESIGNED BY:	Sarah Weight
CUSTOMER:	Phan-Nguyen	REVIEWED BY:	Sarah Weight
PROJ. ADDRESS:	-- Mercer Island, WA	PROJECT NAME:	Phan-Nguyen
LEVEL:	StruCalc Members	LOADING:	ASD
MEMBER NAME:	U12 - DEN/PLAY WDO HDR	CODE:	2018 International Building Code
MEMBER TYPE:	FLOOR BEAM	NDS:	2018 NDS
MATERIAL:	Solid Sawn		
Douglas Fir-Larch	No. 2	(1) 5.5 X 11.5	DRY

U12 - DEN/PLAY WDO HDR DIAGRAM

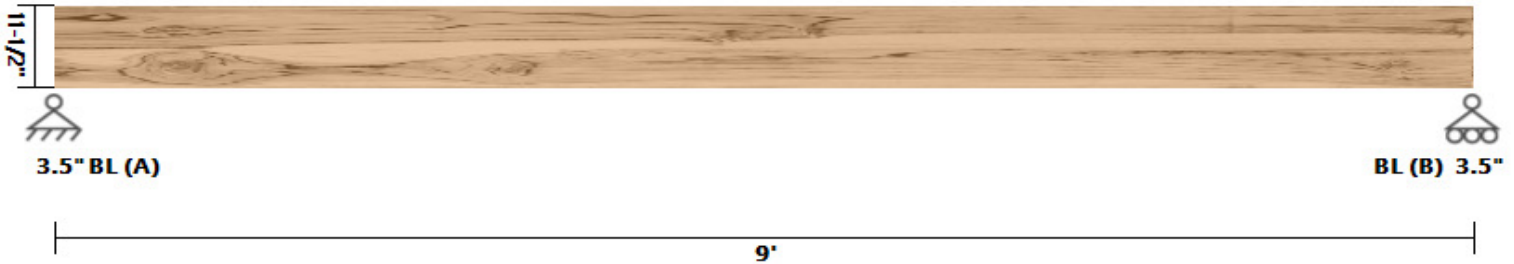

BEAM PROPERTIES

Start (ft): 0 End (ft): 9 Member Slope: 0/12 Actual Length (ft): 9

Area	I _x	I _y	BSW	Lams	G	K _{cr}
(in ²)	(in ⁴)	(in ⁴)	(lbf/ft)			Creep Factor
63.25	697.07	159.44	14.43	1	0.5	1

STRENGTH PROPERTIES

	F _b (psi)	F _t (psi)	F _v (psi)	F _c (psi)	F _{c⊥} (psi)	E (psi) x10 ³	E _{min} (psi) x10 ³
Base Values	875	425	170	600	625	1300	470
Adjusted Values	875	425	170	600	625	1300	470
C _M	1	1	1	1	1	1	1
C _T	1	1	1	1	1	1	1
C _i	1	1	1	1	1	1	1
C _F	1	1	1	1	1	1	1

Bending Adjustment Factors C_{fu} = 1 C_r = 1

BEAM DATA

Span	Length (ft)	Unbraced Length (ft)		Beam End				
		Top	Bottom	Elev. Diff (ft)	CL(Top)	CL(Bottom)	CL(Left)	CL(Right)
1	9	2	9	0	1.00	0.99	1.00	1.00

PASS-FAIL

	PASS/FAIL	MAGNITUDE	STRENGTH	LOCATION (ft)	LOAD COMBO	DURATION FACTOR	CD
Shear Stress Y (psi)	PASS (55.7%)	75.3	170.0	9	D+L	1	
Bending Stress Y (psi)	PASS (19.0%)	707.5	873.7	4.5	D+L	1	
Deflection (in)	PASS (61.7%)	0.115 (=L/939)	0.300 (=L/360)	4.5	D+L		
Bearing Stress (psi)	PASS (72.9%)	169.6	625.0	0	D+0.75L+0.75Lr	1.25	

REACTIONS

Units for V: lbf Units for M: lbf-ft

Y axis	DEAD	LIVE	LIVE ROOF	TOTAL
A	1503	1674	675	3852
B	1503	1674	675	3852

Reaction Location

A

B

LOAD LIST

Type	Name	Left Magnitude	Right Magnitude	Load Start (ft)	Load End (ft)	Load Type	Direction
Trapezoidal (lb/ft)	Trapezoidal	90	90	0	9	Dead	Y
Trapezoidal (lb/ft)	Trapezoidal	150	150	0	9	RoofLive	Y
Trapezoidal (lb/ft)	Trapezoidal	90	90	0	9	Dead	Y
Trapezoidal (lb/ft)	Trapezoidal	372	372	0	9	Live	Y
Trapezoidal (lb/ft)	Trapezoidal	139.5	139.5	0	9	Dead	Y
Self Weight (lb/ft)	-	14.43	14.43	0	9	Dead	Y

PASS

DATE:	3/24/2023	COMPANY:	Architects Northwest
STRUCALC BUILD:	StruCalc Plus	DESIGNED BY:	Sarah Weight
CUSTOMER:	Phan-Nguyen	REVIEWED BY:	Sarah Weight
PROJ. ADDRESS:	-- Mercer Island, WA	PROJECT NAME:	Phan-Nguyen
LEVEL:	StruCalc Members	LOADING:	ASD
MEMBER NAME:	U13 - COV'D PATIO SIDE BEAMS	CODE:	2018 International Building Code
MEMBER TYPE:	FLOOR BEAM	NDS:	2018 NDS
MATERIAL:	Solid Sawn		
Douglas Fir-Larch	No. 2	(1) 3.5 X 11.25	DRY

U13 - COV'D PATIO SIDE BEAMS DIAGRAM**BEAM PROPERTIES**

Start (ft): 0 End (ft): 6.5 Member Slope: 0/12 Actual Length (ft): 6.5

Area	I _x	I _y	BSW	Lams	G	K _{cr}
(in ²)	(in ⁴)	(in ⁴)	(lbf/ft)			Creep Factor
39.38	415.28	40.2	8.98	1	0.5	1

STRENGTH PROPERTIES

	F _b (psi)	F _t (psi)	F _v (psi)	F _c (psi)	F _{c⊥} (psi)	E (psi) x10 ³	E _{min} (psi) x10 ³
Base Values	900	575	180	1350	625	1600	580
Adjusted Values	990	575	180	1350	625	1600	580
C _M	1	1	1	1	1	1	1
C _T	1	1	1	1	1	1	1
C _i	1	1	1	1	1	1	1
C _F	1.1	1	1	1	1	1	1

Bending Adjustment Factors C_{fu} = 1 C_r = 1**BEAM DATA**

Span	Length (ft)	Unbraced Length (ft)		Beam End				
		Top	Bottom	Elev. Diff (ft)	CL(Top)	CL(Bottom)	CL(Left)	CL(Right)
1	6.5	4	6.5	0	0.99	0.99	1.00	1.00

PASS-FAIL

	PASS/FAIL	MAGNITUDE	STRENGTH	LOCATION (ft)	LOAD COMBO	DURATION FACTOR CD
Shear Stress Y (psi)	PASS (99.3%)	1.1	162.0	0	D	0.9
Bending Stress Y (psi)	PASS (99.1%)	7.7	885.2	3.25	D	0.9
Deflection (in)	PASS (99.7%)	0.001 (=L/156024)	0.217 (=L/360)	3.25	D+L	
Bearing Stress (psi)	PASS (99.6%)	2.4	625.0	0	D	0.9

REACTIONS

Units for V: lbf Units for M: lbf-ft

Y axis	DEAD	TOTAL
A	29	29
B	29	29

Reaction Location

A

B

LOAD LIST

Type	Name	Left Magnitude	Right Magnitude	Load Start (ft)	Load End (ft)	Load Type	Direction
Self Weight (lbf/ft)	-	8.98	8.98	0	6.5	Dead	Y

PASS

DATE:	3/24/2023	COMPANY:	Architects Northwest
STRUCALC BUILD:	StruCalc Plus	DESIGNED BY:	Sarah Weight
CUSTOMER:	Phan-Nguyen	REVIEWED BY:	Sarah Weight
PROJ. ADDRESS:	-- Mercer Island, WA	PROJECT NAME:	Phan-Nguyen
LEVEL:	StruCalc Members	LOADING:	ASD
MEMBER NAME:	U13.OT1 - COV'D PATIO SIDE BEAMS	CODE:	2018 International Building Code
MEMBER TYPE:	FLOOR BEAM	NDS:	2018 NDS
MATERIAL:	Solid Sawn		
Douglas Fir-Larch	No. 2	(1) 3.5 X 11.25	DRY

U13.OT1 - COV'D PATIO SIDE BEAMS DIAGRAM**BEAM PROPERTIES**

Start (ft): 0 End (ft): 6.5 Member Slope: 0/12 Actual Length (ft): 6.5

Area	I _x	I _y	BSW	Lams	G	K _{cr}
(in ²)	(in ⁴)	(in ⁴)	(lbf/ft)			Creep Factor
39.38	415.28	40.2	8.98	1	0.5	1

STRENGTH PROPERTIES

	F _b (psi)	F _t (psi)	F _v (psi)	F _c (psi)	F _{c⊥} (psi)	E (psi) x10 ³	E _{min} (psi) x10 ³
Base Values	900	575	180	1350	625	1600	580
Adjusted Values	990	575	180	1350	625	1600	580
C _M	1	1	1	1	1	1	1
C _T	1	1	1	1	1	1	1
C _i	1	1	1	1	1	1	1
C _F	1.1	1	1	1	1	1	1

Bending Adjustment Factors C_{fu} = 1 C_r = 1**BEAM DATA**

Span	Length (ft)	Unbraced Length (ft)		Beam End				
		Top	Bottom	Elev. Diff (ft)	CL(Top)	CL(Bottom)	CL(Left)	CL(Right)
1	6.5	4	6.5	0	0.99	0.99	1.00	1.00

PASS-FAIL

	PASS/FAIL	MAGNITUDE	STRENGTH	LOCATION (ft)	LOAD COMBO	DURATION FACTOR CD
Shear Stress Y (psi)	PASS (99.3%)	1.1	162.0	0	D	0.9
Bending Stress Y (psi)	PASS (99.1%)	7.7	885.2	3.25	D	0.9
Deflection (in)	PASS (99.7%)	0.001 (=L/156024)	0.217 (=L/360)	3.25	D+L	
Bearing Stress (psi)	PASS (99.6%)	2.4	625.0	0	D	0.9

REACTIONS

Units for V: lbf Units for M: lbf-ft

Y axis	DEAD	TOTAL
A	29	29
B	29	29

Reaction Location

A

B

LOAD LIST

Type	Name	Left Magnitude	Right Magnitude	Load Start (ft)	Load End (ft)	Load Type	Direction
Self Weight (lbf/ft)	-	8.98	8.98	0	6.5	Dead	Y

PASS

DATE:	3/24/2023	COMPANY:	Architects Northwest
STRUCALC BUILD:	StruCalc Plus	DESIGNED BY:	Sarah Weight
CUSTOMER:	Phan-Nguyen	REVIEWED BY:	Sarah Weight
PROJ. ADDRESS:	-- Mercer Island, WA	PROJECT NAME:	Phan-Nguyen
LEVEL:	StruCalc Members	LOADING:	ASD
MEMBER NAME:	U13.OT2 - COV'D PATIO SIDE BEAMS	CODE:	2018 International Building Code
MEMBER TYPE:	FLOOR BEAM	NDS:	2018 NDS
MATERIAL:	Solid Sawn		
Douglas Fir-Larch	No. 2	(1) 3.5 X 11.25	DRY

U13.OT2 - COV'D PATIO SIDE BEAMS DIAGRAM**BEAM PROPERTIES**

Start (ft): 0 End (ft): 6.5 Member Slope: 0/12 Actual Length (ft): 6.5

Area	I _x	I _y	BSW	Lams	G	K _{cr}
(in ²)	(in ⁴)	(in ⁴)	(lbf/ft)			Creep Factor
39.38	415.28	40.2	8.98	1	0.5	1

STRENGTH PROPERTIES

	F _b (psi)	F _t (psi)	F _v (psi)	F _c (psi)	F _{c⊥} (psi)	E (psi) x10 ³	E _{min} (psi) x10 ³
Base Values	900	575	180	1350	625	1600	580
Adjusted Values	990	575	180	1350	625	1600	580
C _M	1	1	1	1	1	1	1
C _T	1	1	1	1	1	1	1
C _i	1	1	1	1	1	1	1
C _F	1.1	1	1	1	1	1	1

Bending Adjustment Factors C_{fu} = 1 C_r = 1**BEAM DATA**

Span	Length (ft)	Unbraced Length (ft)		Beam End				
		Top	Bottom	Elev. Diff (ft)	CL(Top)	CL(Bottom)	CL(Left)	CL(Right)
1	6.5	4	6.5	0	0.99	0.99	1.00	1.00

PASS-FAIL

	PASS/FAIL	MAGNITUDE	STRENGTH	LOCATION (ft)	LOAD COMBO	DURATION FACTOR CD
Shear Stress Y (psi)	PASS (99.3%)	1.1	162.0	0	D	0.9
Bending Stress Y (psi)	PASS (99.1%)	7.7	885.2	3.25	D	0.9
Deflection (in)	PASS (99.7%)	0.001 (=L/156024)	0.217 (=L/360)	3.25	D+L	
Bearing Stress (psi)	PASS (99.6%)	2.4	625.0	0	D	0.9

REACTIONS

Units for V: lbf Units for M: lbf-ft

Y axis	DEAD	TOTAL
A	29	29
B	29	29

Reaction Location

A

B

LOAD LIST

Type	Name	Left Magnitude	Right Magnitude	Load Start (ft)	Load End (ft)	Load Type	Direction
Self Weight (lbf/ft)	-	8.98	8.98	0	6.5	Dead	Y

PASS

DATE:	3/24/2023	COMPANY:	Architects Northwest
STRUCALC BUILD:	StruCalc Plus	DESIGNED BY:	Sarah Weight
CUSTOMER:	Phan-Nguyen	REVIEWED BY:	Sarah Weight
PROJ. ADDRESS:	-- Mercer Island, WA	PROJECT NAME:	Phan-Nguyen
LEVEL:	StruCalc Members	LOADING:	ASD
MEMBER NAME:	U14 - COV'D ENTRY BEAM	CODE:	2018 International Building Code
MEMBER TYPE:	FLOOR BEAM	NDS:	2018 NDS
MATERIAL:	Glulams		
Stress Class Rated 24F-1.8E	24F-V4 DF/DF	(1) 5.125 X 15	DRY

U14 - COV'D ENTRY BEAM DIAGRAM



BEAM PROPERTIES

Start (ft): 0 End (ft): 14.5 Member Slope: 0/12 Actual Length (ft): 14.5

Area	Ix	Iy	BSW	Lams	G	Kcr
(in ²)	(in ⁴)	(in ⁴)	(lbf/ft)			Creep Factor
76.88	1441.41	168.26	17.53	1	0.5	1

STRENGTH PROPERTIES

	Fbx+	Fbx-	Fby	Ft	Fvx	Fvy	Fc	Fc _⊥	Ex	Exmin	Ey	Eymin
	(psi)	(psi)	(psi)	(psi)	(psi)	(psi)	(psi)	(psi)	(psi)	(psi)	(psi)	(psi)
Base Values	2400	1850	1450	1100	265	230	1650	650	1800000	950000	1600000	850000
Adjusted Values	2400	1850	1450	1100	265	230	1650	650	1800000	950000	1600000	850000
C _M	1	1	1	1	1	1	1	1	1	1	1	1
C _T	1	1	1	1	1	1	1	1	1	1	1	1

Bending Adjustment Factors C_{Vr} = 1

BEAM DATA

Span	Length (ft)	Unbraced Length (ft)		Beam End				
		Top	Bottom	Elev. Diff (ft)	CL(Top)	CL(Bottom)	CL(Left)	CL(Right)
1	14.5	2	14.5	0	1.00	0.97	1.00	1.00

PASS-FAIL

	PASS/FAIL	MAGNITUDE	STRENGTH	LOCATION (ft)	LOAD COMBO	DURATION FACTOR CD
Shear Stress Y (psi)	PASS (94.9%)	17.0	331.3	14.5	D+Lr	1.25
Bending Stress Y (psi)	PASS (95.6%)	132.4	2986.5	11.89	D+Lr	1.25
Deflection (in)	PASS (94.4%)	0.027 (=L/6420)	0.483 (=L/360)	7.97	D+Lr	
Bearing Stress (psi)	PASS (91.3%)	48.6	560.0	14.5	D+Lr	1.25

REACTIONS

Units for V: lbf Units for M: lbf-ft

Y axis	DEAD	LIVE ROOF	TOTAL
A	221	90	311
B	439	433	872

Reaction Location



LOAD LIST

Type	Name	Left Magnitude	Right Magnitude	Load Start (ft)	Load End (ft)	Load Type	Direction
Self Weight (lbf/ft)	-	17.53	17.53	0	14.5	Dead	Y

LINKED LOAD LIST

Type	Left Magnitude	Right Magnitude	Load Start (ft)	Load End (ft)	Load Type	Direction
Point (lbf)	340.3019	-	12	-	Dead	Y
Point (lbf)	523.0286	-	12	-	RoofLive	Y
Point (lbf)	28.90823	-	3	-	Dead	Y
Point (lbf)	35.66985	-	9.7	-	Dead	Y

DATE:	3/24/2023	COMPANY:	Architects Northwest
STRUCALC BUILD:	StruCalc Plus	DESIGNED BY:	Sarah Weight
CUSTOMER:	Phan-Nguyen	REVIEWED BY:	Sarah Weight
PROJ. ADDRESS:	--	PROJECT NAME:	Phan-Nguyen
	, Mercer Island, WA		
LEVEL:	StruCalc Members	LOADING:	ASD
MEMBER NAME:	M01 - GARAGE OHD HDR	CODE:	2018 International Building Code
MEMBER TYPE:	FLOOR BEAM	NDS:	2018 NDS
MATERIAL:	Solid Sawn		
Douglas Fir-Larch	No. 2	(1) 5.5 X 11.5	DRY

M01 - GARAGE OHD HDR DIAGRAM

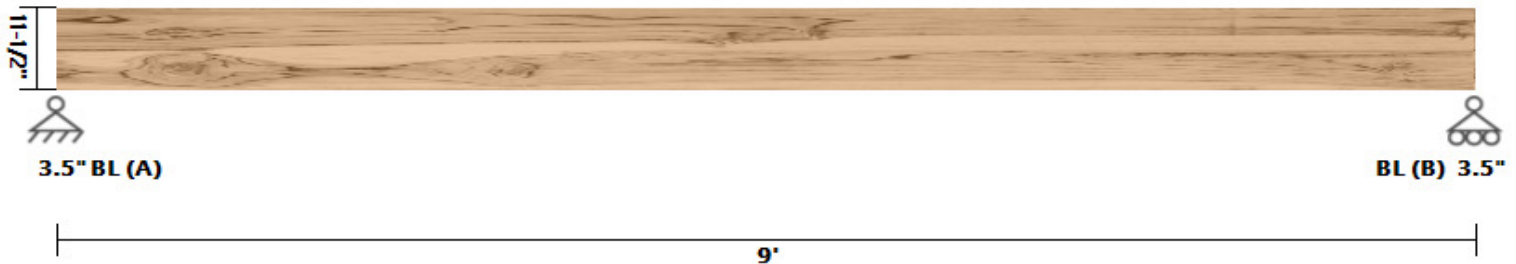

BEAM PROPERTIES

Start (ft): 0 End (ft): 9 Member Slope: 0/12 Actual Length (ft): 9

Area	I _x	I _y	BSW	Lams	G	K _{cr}
(in ²)	(in ⁴)	(in ⁴)	(lbf/ft)			Creep Factor
63.25	697.07	159.44	14.43	1	0.5	1

STRENGTH PROPERTIES

	F _b (psi)	F _t (psi)	F _v (psi)	F _c (psi)	F _{c⊥} (psi)	E (psi) x10 ³	E _{min} (psi) x10 ³
Base Values	875	425	170	600	625	1300	470
Adjusted Values	875	425	170	600	625	1300	470
C _M	1	1	1	1	1	1	1
C _T	1	1	1	1	1	1	1
C _i	1	1	1	1	1	1	1
C _F	1	1	1	1	1	1	1

Bending Adjustment Factors C_{fu} = 1 C_r = 1

BEAM DATA

Span	Length (ft)	Unbraced Length (ft)		Beam End				
		Top	Bottom	Elev. Diff (ft)	CL(Top)	CL(Bottom)	CL(Left)	CL(Right)
1	9	2	9	0	1.00	0.99	1.00	1.00

PASS-FAIL

	PASS/FAIL	MAGNITUDE	STRENGTH	LOCATION (ft)	LOAD COMBO	DURATION FACTOR	CD
Shear Stress Y (psi)	PASS (60.0%)	68.1	170.0	9	D+L	1	
Bending Stress Y (psi)	PASS (26.8%)	639.4	873.7	4.5	D+L	1	
Deflection (in)	PASS (65.4%)	0.104 (=L/1039)	0.300 (=L/360)	4.5	D+L		
Bearing Stress (psi)	PASS (76.1%)	149.1	625.0	9	D+L	1	

REACTIONS

Units for V: lbf Units for M: lbf-ft

Y axis	DEAD	LIVE	TOTAL
A	1125	1746	2871
B	1125	1746	2871

Reaction Location

A

B

LOAD LIST

Type	Name	Left Magnitude	Right Magnitude	Load Start (ft)	Load End (ft)	Load Type	Direction
Trapezoidal (lb/ft)	Trapezoidal	388	388	0	9	Live	Y
Trapezoidal (lb/ft)	Trapezoidal	145.5	145.5	0	9	Dead	Y
Trapezoidal (lb/ft)	Trapezoidal	90	90	0	9	Dead	Y
Self Weight (lb/ft)	-	14.43	14.43	0	9	Dead	Y

PASS

DATE:	3/24/2023	COMPANY:	Architects Northwest
STRUCALC BUILD:	StruCalc Plus	DESIGNED BY:	Sarah Weight
CUSTOMER:	Phan-Nguyen	REVIEWED BY:	Sarah Weight
PROJ. ADDRESS:	-- Mercer Island, WA	PROJECT NAME:	Phan-Nguyen
LEVEL:	StruCalc Members	LOADING:	ASD
MEMBER NAME:	M02 - GARAGE BEAM	CODE:	2018 International Building Code
MEMBER TYPE:	FLOOR BEAM	NDS:	2018 NDS
MATERIAL:	Glulams		
Stress Class Rated 24F-1.8E	24F-V4 DF/DF	(1) 3.125 X 12	DRY

M02 - GARAGE BEAM DIAGRAM

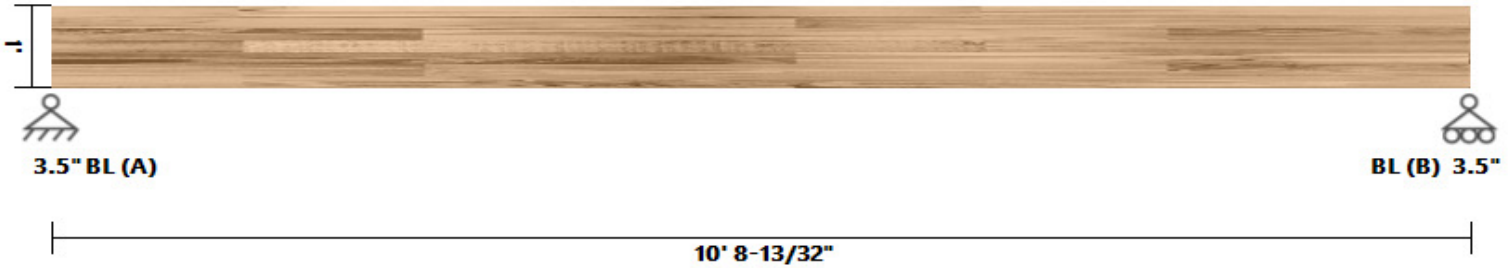

BEAM PROPERTIES

Start (ft): 0 End (ft): 10.7 Member Slope: 0/12 Actual Length (ft): 10.7

Area	Ix	Iy	BSW	Lams	G	Kcr
(in ²)	(in ⁴)	(in ⁴)	(lbf/ft)			Creep Factor
37.5	450	30.52	8.55	1	0.5	1

STRENGTH PROPERTIES

	Fbx+	Fbx-	Fby	Ft	Fvx	Fvy	Fc	Fc _⊥	Ex	Exmin	Ey	Eymin
	(psi)	(psi)	(psi)	(psi)	(psi)	(psi)	(psi)	(psi)	(psi)	(psi)	(psi)	(psi)
Base Values	2400	1850	1450	1100	265	230	1650	650	1800000	950000	1600000	850000
Adjusted Values	2400	1850	1450	1100	265	230	1650	650	1800000	950000	1600000	850000
C _M	1	1	1	1	1	1	1	1	1	1	1	1
C _T	1	1	1	1	1	1	1	1	1	1	1	1

Bending Adjustment Factors C_{Vr} = 1

BEAM DATA

Span	Length (ft)	Unbraced Length (ft)		Beam End					
		Top	Bottom	Elev. Diff (ft)	CL(Top)	CL(Bottom)	CL(Left)	CL(Right)	
1	10.7	4	10.7	0	0.98	0.96	1.00	1.00	

PASS-FAIL

	PASS/FAIL	MAGNITUDE	STRENGTH	LOCATION (ft)	LOAD COMBO	DURATION FACTOR CD
Shear Stress Y (psi)	PASS (84.2%)	41.9	265.0	0	D+L	1
Bending Stress Y (psi)	PASS (80.7%)	455.4	2354.1	5.14	D+L	1
Deflection (in)	PASS (79.8%)	0.072 (=L/1781)	0.357 (=L/360)	5.35	D+L	
Bearing Stress (psi)	PASS (82.9%)	95.7	560.0	0	D+L	1

REACTIONS

Y axis	DEAD	LIVE	TOTAL
A	619	428	1047
B	589	428	1017

Reaction Location



LOAD LIST

Type	Name	Left Magnitude	Right Magnitude	Load Start (ft)	Load End (ft)	Load Type	Direction
Trapezoidal (lbf/ft)	Trapezoidal	80	80	0	10.7	Live	Y
Trapezoidal (lbf/ft)	Trapezoidal	30	30	0	10.7	Dead	Y
Trapezoidal (lbf/ft)	Trapezoidal	63	63	0	10.7	Dead	Y
Self Weight (lbf/ft)	-	8.55	8.55	0	10.7	Dead	Y

LINKED LOAD LIST

Type	Left Magnitude	Right Magnitude	Load Start (ft)	Load End (ft)	Load Type	Direction
Point (lbf)	121.1266	-	4	-	Dead	Y

PASS

DATE:	3/24/2023	COMPANY:	Architects Northwest
STRUCALC BUILD:	StruCalc Plus	DESIGNED BY:	Sarah Weight
CUSTOMER:	Phan-Nguyen	REVIEWED BY:	Sarah Weight
PROJ. ADDRESS:	-- Mercer Island, WA	PROJECT NAME:	Phan-Nguyen
LEVEL:	StruCalc Members	LOADING:	ASD
MEMBER NAME:	M03 - GARAGE BEAM	CODE:	2018 International Building Code
MEMBER TYPE:	FLOOR BEAM	NDS:	2018 NDS
MATERIAL:	Glulams		
Stress Class Rated 24F-1.8E	24F-V4 DF/DF	(1) 5.5 X 22.5	DRY

M03 - GARAGE BEAM DIAGRAM

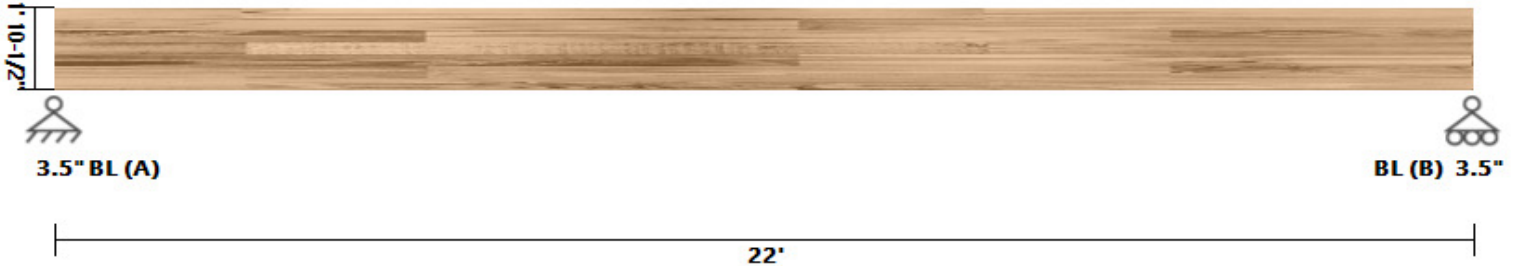

BEAM PROPERTIES

Start (ft): 0 End (ft): 22 Member Slope: 0/12 Actual Length (ft): 22

Area	Ix	Iy	BSW	Lams	G	Kcr
(in ²)	(in ⁴)	(in ⁴)	(lbf/ft)			Creep Factor
123.75	5220.7	311.95	28.22	1	0.5	1

STRENGTH PROPERTIES

	Fbx+	Fbx-	Fby	Ft	Fvx	Fvy	Fc	Fc _⊥	Ex	Exmin	Ey	Eymin
	(psi)	(psi)	(psi)	(psi)	(psi)	(psi)	(psi)	(psi)	(psi)	(psi)	(psi)	(psi)
Base Values	2400	1850	1450	1100	265	230	1650	650	1800000	950000	1600000	850000
Adjusted Values	2400	1850	1450	1100	265	230	1650	650	1800000	950000	1600000	850000
C _M	1	1	1	1	1	1	1	1	1	1	1	1
C _T	1	1	1	1	1	1	1	1	1	1	1	1

Bending Adjustment Factors C_{Vr} = 1

BEAM DATA

Span	Length (ft)	Unbraced Length (ft)		Beam End					
		Top	Bottom	Elev. Diff (ft)	CL(Top)	CL(Bottom)	CL(Left)	CL(Right)	
1	22	2	22	0	1.00	0.94	1.00	1.00	

PASS-FAIL

	PASS/FAIL	MAGNITUDE	STRENGTH	LOCATION (ft)	LOAD COMBO	DURATION FACTOR CD
Shear Stress Y (psi)	PASS (61.9%)	100.9	265.0	22	D+L	1
Bending Stress Y (psi)	PASS (49.7%)	1121.0	2227.5	11.22	D+L	1
Deflection (in)	PASS (44.8%)	0.405 (=L/653)	0.733 (=L/360)	11	D+L	
Bearing Stress (psi)	PASS (22.8%)	432.4	560.0	22	D+L	1

REACTIONS

Units for V: lbf Units for M: lbf-ft

Y axis	DEAD	LIVE	TOTAL
A	2887	4790	7677
B	3270	5054	8324

Reaction Location



LOAD LIST

Type	Name	Left Magnitude	Right Magnitude	Load Start (ft)	Load End (ft)	Load Type	Direction
Trapezoidal (lb/ft)	Trapezoidal	428	428	0	22	Live	Y
Trapezoidal (lb/ft)	Trapezoidal	160.5	160.5	0	22	Dead	Y
Trapezoidal (lb/ft)	Trapezoidal	63	63	0	22	Dead	Y
Self Weight (lb/ft)	-	28.22	28.22	0	22	Dead	Y

LINKED LOAD LIST

Type	Left Magnitude	Right Magnitude	Load Start (ft)	Load End (ft)	Load Type	Direction
Point (lb)	619.1519	-	17.8	-	Dead	Y
Point (lb)	427.9998	-	17.8	-	Live	Y

PASS

DATE:	3/24/2023	COMPANY:	Architects Northwest
STRUCALC BUILD:	StruCalc Plus	DESIGNED BY:	Sarah Weight
CUSTOMER:	Phan-Nguyen	REVIEWED BY:	Sarah Weight
PROJ. ADDRESS:	--	PROJECT NAME:	Phan-Nguyen
	Mercer Island, WA		
LEVEL:	StruCalc Members	LOADING:	ASD
MEMBER NAME:	M04 - GARAGE OHD HDR	CODE:	2018 International Building Code
MEMBER TYPE:	FLOOR BEAM	NDS:	2018 NDS
MATERIAL:	Glulams		
Stress Class Rated 24F-1.8E	24F-V4 DF/DF	(1) 6.75 X 15	DRY

M04 - GARAGE OHD HDR DIAGRAM

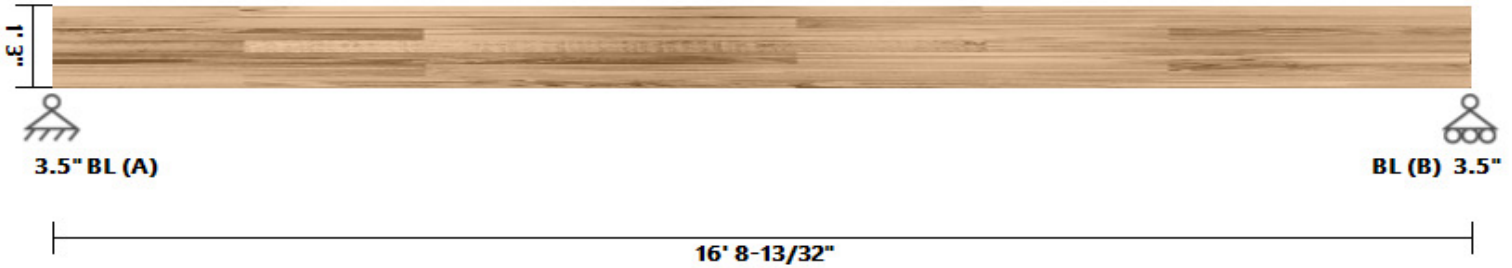

BEAM PROPERTIES

Start (ft): 0 End (ft): 16.7 Member Slope: 0/12 Actual Length (ft): 16.7

Area	Ix	Iy	BSW	Lams	G	Kcr
(in ²)	(in ⁴)	(in ⁴)	(lbf/ft)			Creep Factor
101.25	1898.44	384.43	23.09	1	0.5	1

STRENGTH PROPERTIES

	Fbx+	Fbx-	Fby	Ft	Fvx	Fvy	Fc	Fc _⊥	Ex	Exmin	Ey	Eymin
	(psi)	(psi)	(psi)	(psi)	(psi)	(psi)	(psi)	(psi)	(psi)	(psi)	(psi)	(psi)
Base Values	2400	1850	1450	1100	265	230	1650	650	1800000	950000	1600000	850000
Adjusted Values	2400	1850	1450	1100	265	230	1650	650	1800000	950000	1600000	850000
C _M	1	1	1	1	1	1	1	1	1	1	1	1
C _T	1	1	1	1	1	1	1	1	1	1	1	1

Bending Adjustment Factors C_{Vr} = 1

BEAM DATA

Span	Length (ft)	Unbraced Length (ft)		Beam End				
		Top	Bottom	Elev. Diff (ft)	CL(Top)	CL(Bottom)	CL(Left)	CL(Right)
1	16.7	2	16.7	0	1.00	0.99	1.00	1.00

PASS-FAIL

	PASS/FAIL	MAGNITUDE	STRENGTH	LOCATION (ft)	LOAD COMBO	DURATION FACTOR CD
Shear Stress Y (psi)	PASS (72.2%)	73.8	265.0	16.7	D+L	1
Bending Stress Y (psi)	PASS (76.0%)	560.2	2336.2	8.35	D+L	1
Deflection (in)	PASS (63.9%)	0.201 (=L/997)	0.557 (=L/360)	8.35	D+L	
Bearing Stress (psi)	PASS (62.4%)	210.8	560.0	0	D+L	1

REACTIONS

Units for V: lbf Units for M: lbf-ft

Y axis	DEAD	LIVE	TOTAL
A	1990	2990	4980
B	1990	2990	4980

Reaction Location



LOAD LIST

Type	Name	Left Magnitude	Right Magnitude	Load Start (ft)	Load End (ft)	Load Type	Direction
Self Weight (lbf/ft)	-	23.09	23.09	0	16.7	Dead	Y

LINKED LOAD LIST

Type	Left Magnitude	Right Magnitude	Load Start (ft)	Load End (ft)	Load Type	Direction
Point (lbf)	1797.421	-	2.3	-	Dead	Y
Point (lbf)	1797.421	-	14.4	-	Dead	Y
Point (lbf)	2990	-	2.3	-	Live	Y
Point (lbf)	2990	-	14.4	-	Live	Y

PASS

DATE:	3/24/2023	COMPANY:	Architects Northwest
STRUCALC BUILD:	StruCalc Plus	DESIGNED BY:	Sarah Weight
CUSTOMER:	Phan-Nguyen	REVIEWED BY:	Sarah Weight
PROJ. ADDRESS:	-- Mercer Island, WA	PROJECT NAME:	Phan-Nguyen
LEVEL:	StruCalc Members	LOADING:	ASD
MEMBER NAME:	M05 - BR7 WDO HDR	CODE:	2018 International Building Code
MEMBER TYPE:	FLOOR BEAM	NDS:	2018 NDS
MATERIAL:	Glulams		
Stress Class Rated 24F-1.8E	24F-V4 DF/DF	(1) 5.125 X 10.5	DRY

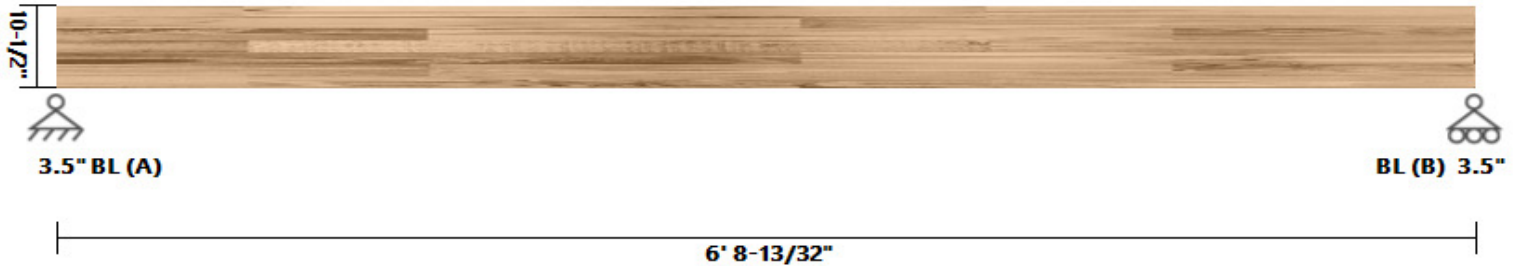
M05 - BR7 WDO HDR DIAGRAM**BEAM PROPERTIES**

Start (ft): 0 End (ft): 6.7 Member Slope: 0/12 Actual Length (ft): 6.7

Area	I _x	I _y	BSW	Lams	G	K _{cr}
(in ²)	(in ⁴)	(in ⁴)	(lbf/ft)			Creep Factor
53.81	494.4	117.78	12.27	1	0.5	1

STRENGTH PROPERTIES

	F _{bx} +	F _{bx} -	F _{by}	F _t	F _{vx}	F _{vy}	F _c	F _{c⊥}	E _x	E _{xmin}	E _y	E _{ymin}
	(psi)	(psi)	(psi)	(psi)	(psi)	(psi)	(psi)	(psi)	(psi)	(psi)	(psi)	(psi)
Base Values	2400	1850	1450	1100	265	230	1650	650	1800000	950000	1600000	850000
Adjusted Values	2400	1850	1472	1100	265	230	1650	650	1800000	950000	1600000	850000
C _M	1	1	1	1	1	1	1	1	1	1	1	1
C _T	1	1	1	1	1	1	1	1	1	1	1	1
Bending Adjustment Factors	C _{Vr} = 1											

BEAM DATA

Span	Length (ft)	Unbraced Length (ft)		Beam End				
		Top	Bottom	Elev. Diff (ft)	CL(Top)	CL(Bottom)	CL(Left)	CL(Right)
1	6.7	2	6.7	0	1.00	1.00	1.00	1.00

PASS-FAIL

	PASS/FAIL	MAGNITUDE	STRENGTH	LOCATION (ft)	LOAD COMBO	DURATION FACTOR CD
Shear Stress Y (psi)	PASS (99.3%)	1.6	238.5	0	D	0.9
Bending Stress Y (psi)	PASS (99.5%)	10.0	2155.3	3.15	D	0.9
Deflection (in)	PASS (99.7%)	0.001 (=L/114840)	0.223 (=L/360)	3.28	D+L	
Bearing Stress (psi)	PASS (99.4%)	3.3	560.0	0	D	0.9

REACTIONS

Units for V: lbf Units for M: lbf-ft

Y axis	DEAD	TOTAL
A	59	59
B	44	44

Reaction Location

A

B

LOAD LIST

Type	Name	Left Magnitude	Right Magnitude	Load Start (ft)	Load End (ft)	Load Type	Direction
Self Weight (lbf/ft)	-	12.27	12.27	0	6.7	Dead	Y

LINKED LOAD LIST

Type	Left Magnitude	Right Magnitude	Load Start (ft)	Load End (ft)	Load Type	Direction
Point (lbf)	20.35526	-	0.9	-	Dead	Y

PASS

DATE:	3/24/2023	COMPANY:	Architects Northwest
STRUCALC BUILD:	StruCalc Plus	DESIGNED BY:	Sarah Weight
CUSTOMER:	Phan-Nguyen	REVIEWED BY:	Sarah Weight
PROJ. ADDRESS:	-- Mercer Island, WA	PROJECT NAME:	Phan-Nguyen
LEVEL:	StruCalc Members	LOADING:	ASD
MEMBER NAME:	M05.OT1 - BR7 WDO HDR	CODE:	2018 International Building Code
MEMBER TYPE:	FLOOR BEAM	NDS:	2018 NDS
MATERIAL:	Glulams		
Stress Class Rated 24F-1.8E	24F-V4 DF/DF	(1) 5.125 X 10.5	DRY

M05.OT1 - BR7 WDO HDR DIAGRAM

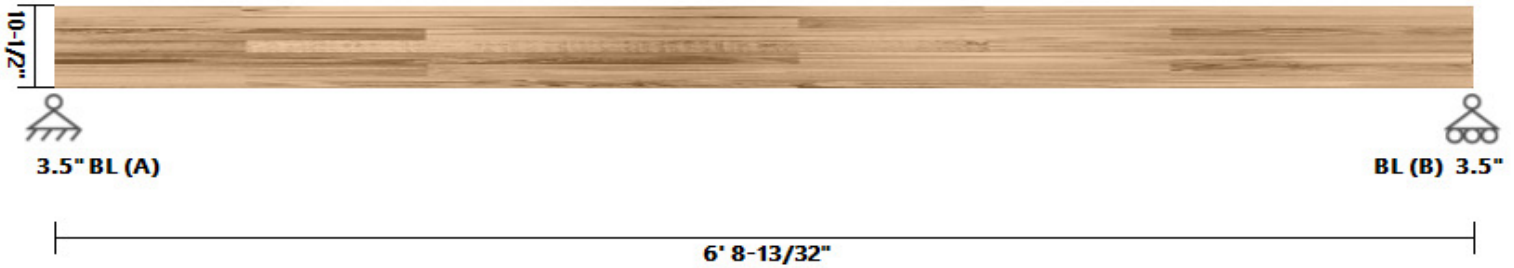

BEAM PROPERTIES

Start (ft): 0 End (ft): 6.7 Member Slope: 0/12 Actual Length (ft): 6.7

Area	Ix	Iy	BSW	Lams	G	Kcr
(in ²)	(in ⁴)	(in ⁴)	(lbf/ft)			Creep Factor
53.81	494.4	117.78	12.27	1	0.5	1

STRENGTH PROPERTIES

	Fbx+	Fbx-	Fby	Ft	Fvx	Fvy	Fc	Fc _⊥	Ex	Exmin	Ey	Eymin
	(psi)	(psi)	(psi)	(psi)	(psi)	(psi)	(psi)	(psi)	(psi)	(psi)	(psi)	(psi)
Base Values	2400	1850	1450	1100	265	230	1650	650	1800000	950000	1600000	850000
Adjusted Values	2400	1850	1472	1100	265	230	1650	650	1800000	950000	1600000	850000
C _M	1	1	1	1	1	1	1	1	1	1	1	1
C _T	1	1	1	1	1	1	1	1	1	1	1	1

Bending Adjustment Factors C_{Vr} = 1

BEAM DATA

Span	Length (ft)	Unbraced Length (ft)		Beam End				
		Top	Bottom	Elev. Diff (ft)	CL(Top)	CL(Bottom)	CL(Left)	CL(Right)
1	6.7	2	6.7	0	1.00	1.00	1.00	1.00

PASS-FAIL

	PASS/FAIL	MAGNITUDE	STRENGTH	LOCATION (ft)	LOAD COMBO	DURATION FACTOR CD
Shear Stress Y (psi)	PASS (99.5%)	1.1	238.5	6.7	D	0.9
Bending Stress Y (psi)	PASS (99.6%)	8.8	2155.3	3.35	D	0.9
Deflection (in)	PASS (99.7%)	0.001 (=L/133980)	0.223 (=L/360)	3.35	D+L	
Bearing Stress (psi)	PASS (99.6%)	2.3	560.0	0	D	0.9

REACTIONS

Units for V: lbf Units for M: lbf-ft

Y axis	DEAD	TOTAL
A	41	41
B	41	41

Reaction Location



LOAD LIST

Type	Name	Left Magnitude	Right Magnitude	Load Start (ft)	Load End (ft)	Load Type	Direction
Self Weight (lbf/ft)	-	12.27	12.27	0	6.7	Dead	Y

PASS

DATE:	3/24/2023	COMPANY:	Architects Northwest
STRUCALC BUILD:	StruCalc Plus	DESIGNED BY:	Sarah Weight
CUSTOMER:	Phan-Nguyen	REVIEWED BY:	Sarah Weight
PROJ. ADDRESS:	-- Mercer Island, WA	PROJECT NAME:	Phan-Nguyen
LEVEL:	StruCalc Members	LOADING:	ASD
MEMBER NAME:	M05.OT2 - BR7 WDO HDR	CODE:	2018 International Building Code
MEMBER TYPE:	FLOOR BEAM	NDS:	2018 NDS
MATERIAL:	Glulams		
Stress Class Rated 24F-1.8E	24F-V4 DF/DF	(1) 5.125 X 10.5	DRY

M05.OT2 - BR7 WDO HDR DIAGRAM

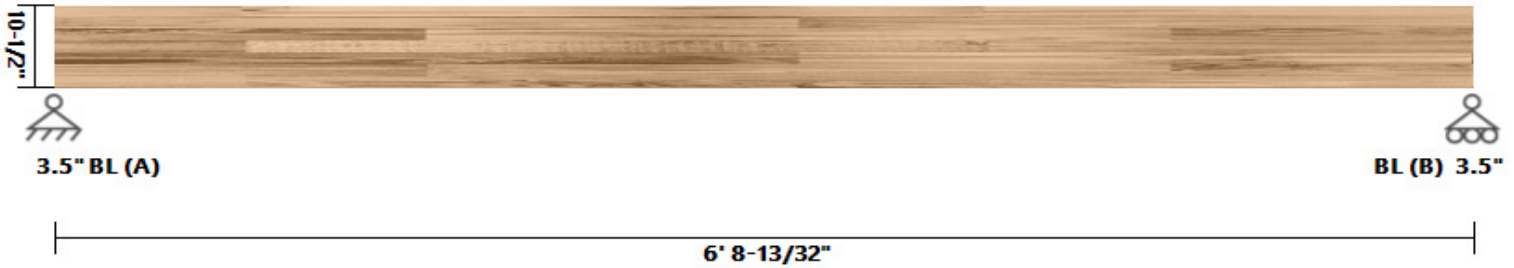

BEAM PROPERTIES

Start (ft): 0 End (ft): 6.7 Member Slope: 0/12 Actual Length (ft): 6.7

Area	Ix	Iy	BSW	Lams	G	Kcr
(in ²)	(in ⁴)	(in ⁴)	(lbf/ft)			Creep Factor
53.81	494.4	117.78	12.27	1	0.5	1

STRENGTH PROPERTIES

	Fbx+	Fbx-	Fby	Ft	Fvx	Fvy	Fc	Fc _⊥	Ex	Exmin	Ey	Eymin
	(psi)	(psi)	(psi)	(psi)	(psi)	(psi)	(psi)	(psi)	(psi)	(psi)	(psi)	(psi)
Base Values	2400	1850	1450	1100	265	230	1650	650	1800000	950000	1600000	850000
Adjusted Values	2400	1850	1472	1100	265	230	1650	650	1800000	950000	1600000	850000
C _M	1	1	1	1	1	1	1	1	1	1	1	1
C _T	1	1	1	1	1	1	1	1	1	1	1	1

Bending Adjustment Factors C_{Vr} = 1

BEAM DATA

Span	Length (ft)	Unbraced Length (ft)		Beam End				
		Top	Bottom	Elev. Diff (ft)	CL(Top)	CL(Bottom)	CL(Left)	CL(Right)
1	6.7	2	6.7	0	1.00	1.00	1.00	1.00

PASS-FAIL

	PASS/FAIL	MAGNITUDE	STRENGTH	LOCATION (ft)	LOAD COMBO	DURATION FACTOR CD
Shear Stress Y (psi)	PASS (99.5%)	1.1	238.5	6.7	D	0.9
Bending Stress Y (psi)	PASS (99.6%)	8.8	2155.3	3.35	D	0.9
Deflection (in)	PASS (99.7%)	0.001 (=L/133980)	0.223 (=L/360)	3.35	D+L	
Bearing Stress (psi)	PASS (99.6%)	2.3	560.0	0	D	0.9

REACTIONS

Units for V: lbf Units for M: lbf-ft

Y axis	DEAD	TOTAL
A	41	41
B	41	41



LOAD LIST

Type	Name	Left Magnitude	Right Magnitude	Load Start (ft)	Load End (ft)	Load Type	Direction
Self Weight (lbf/ft)	-	12.27	12.27	0	6.7	Dead	Y

DATE:	3/24/2023	COMPANY:	Architects Northwest
STRUCALC BUILD:	StruCalc Plus	DESIGNED BY:	Sarah Weight
CUSTOMER:	Phan-Nguyen	REVIEWED BY:	Sarah Weight
PROJ. ADDRESS:	-- Mercer Island, WA	PROJECT NAME:	Phan-Nguyen
LEVEL:	StruCalc Members	LOADING:	ASD
MEMBER NAME:	M06 - BR7 BEAM	CODE:	2018 International Building Code
MEMBER TYPE:	FLOOR BEAM	NDS:	2018 NDS
MATERIAL:	Glulams		
Stress Class Rated 24F-1.8E	24F-V4 DF/DF	(1) 3.125 X 16.5	DRY

M06 - BR7 BEAM DIAGRAM

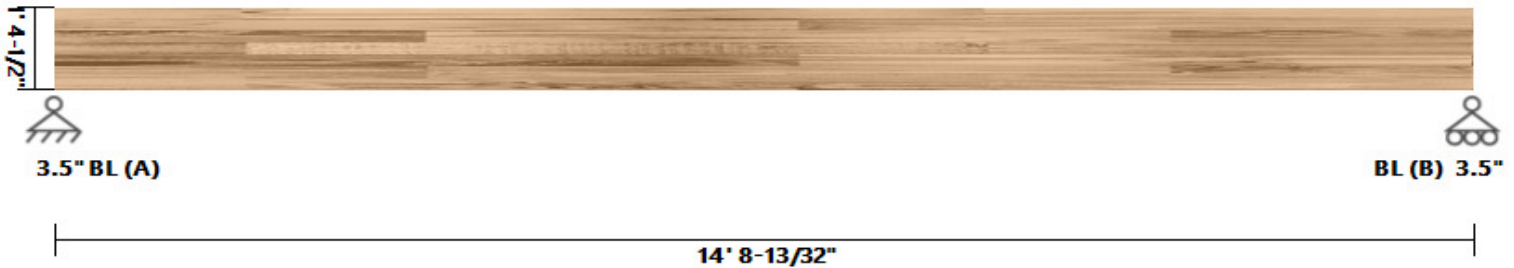

BEAM PROPERTIES

Start (ft): 0 End (ft): 14.7 Member Slope: 0/12 Actual Length (ft): 14.7

Area	Ix	Iy	BSW	Lams	G	Kcr
(in ²)	(in ⁴)	(in ⁴)	(lbf/ft)			Creep Factor
51.56	1169.82	41.96	11.76	1	0.5	1

STRENGTH PROPERTIES

	Fbx+	Fbx-	Fby	Ft	Fvx	Fvy	Fc	Fc _⊥	Ex	Exmin	Ey	Eymin
	(psi)	(psi)	(psi)	(psi)	(psi)	(psi)	(psi)	(psi)	(psi)	(psi)	(psi)	(psi)
Base Values	2400	1850	1450	1100	265	230	1650	650	1800000	950000	1600000	850000
Adjusted Values	2400	1850	1450	1100	265	230	1650	650	1800000	950000	1600000	850000
C _M	1	1	1	1	1	1	1	1	1	1	1	1
C _T	1	1	1	1	1	1	1	1	1	1	1	1
Bending Adjustment Factors	C _{Vr} = 1											

BEAM DATA

Span	Length (ft)	Unbraced Length (ft)		Beam End				
		Top	Bottom	Elev. Diff (ft)	CL(Top)	CL(Bottom)	CL(Left)	CL(Right)
1	14.7	2	14.7	0	0.99	0.89	1.00	1.00

PASS-FAIL

	PASS/FAIL	MAGNITUDE	STRENGTH	LOCATION (ft)	LOAD COMBO	DURATION FACTOR CD
Shear Stress Y (psi)	PASS (98.9%)	2.5	238.5	14.7	D	0.9
Bending Stress Y (psi)	PASS (98.7%)	26.9	2137.3	7.35	D	0.9
Deflection (in)	PASS (98.8%)	0.006 (=L/29898)	0.490 (=L/360)	7.35	D+L	
Bearing Stress (psi)	PASS (98.6%)	7.9	560.0	0	D	0.9

REACTIONS

Units for V: lbf Units for M: lbf-ft

Y axis	DEAD	TOTAL
A	86	86
B	86	86

Reaction Location

A

B

LOAD LIST

Type	Name	Left Magnitude	Right Magnitude	Load Start (ft)	Load End (ft)	Load Type	Direction
Self Weight (lbf/ft)	-	11.76	11.76	0	14.7	Dead	Y

PASS

DATE:	3/24/2023	COMPANY:	Architects Northwest
STRUCALC BUILD:	StruCalc Plus	DESIGNED BY:	Sarah Weight
CUSTOMER:	Phan-Nguyen	REVIEWED BY:	Sarah Weight
PROJ. ADDRESS:	-- Mercer Island, WA	PROJECT NAME:	Phan-Nguyen
LEVEL:	StruCalc Members	LOADING:	ASD
MEMBER NAME:	M07 - OFFICE 2 WDO HDR	CODE:	2018 International Building Code
MEMBER TYPE:	FLOOR BEAM	NDS:	2018 NDS
MATERIAL:	Solid Sawn		
Douglas Fir-Larch	No. 2	(1) 3.5 X 9.25	DRY

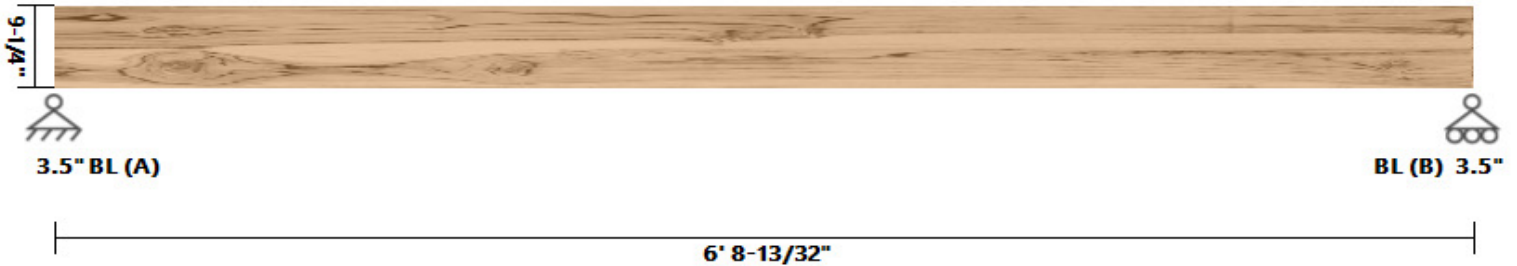
M07 - OFFICE 2 WDO HDR DIAGRAM**BEAM PROPERTIES**

Start (ft): 0 End (ft): 6.7 Member Slope: 0/12 Actual Length (ft): 6.7

Area	I _x	I _y	BSW	Lams	G	K _{cr}
(in ²)	(in ⁴)	(in ⁴)	(lbf/ft)			Creep Factor
32.38	230.84	33.05	7.38	1	0.5	1

STRENGTH PROPERTIES

	F _b (psi)	F _t (psi)	F _v (psi)	F _c (psi)	F _{c⊥} (psi)	E (psi) x10 ³	E _{min} (psi) x10 ³
Base Values	900	575	180	1350	625	1600	580
Adjusted Values	1080	632	180	1350	625	1600	580
C _M	1	1	1	1	1	1	1
C _T	1	1	1	1	1	1	1
C _i	1	1	1	1	1	1	1
C _F	1.2	1.1	1	1	1	1	1

Bending Adjustment Factors C_{fu} = 1 C_r = 1**BEAM DATA**

Span	Length (ft)	Unbraced Length (ft)		Beam End				
		Top	Bottom	Elev. Diff (ft)	CL(Top)	CL(Bottom)	CL(Left)	CL(Right)
1	6.7	4	6.7	0	0.99	0.99	1.00	1.00

PASS-FAIL

	PASS/FAIL	MAGNITUDE	STRENGTH	LOCATION (ft)	LOAD COMBO	DURATION FACTOR CD
Shear Stress Y (psi)	PASS (66.6%)	60.1	180.0	6.7	D+L	1
Bending Stress Y (psi)	PASS (51.3%)	522.6	1073.0	3.35	D+L	1
Deflection (in)	PASS (74.9%)	0.056 (=L/1433)	0.223 (=L/360)	3.35	D+Lr	
Bearing Stress (psi)	PASS (79.0%)	131.2	625.0	0	D+0.75L+0.75Lr	1.25

REACTIONS

Units for V: lbf Units for M: lbf-ft

Y axis	DEAD	LIVE	LIVE ROOF	TOTAL
A	1030	268	502	1800
B	1030	268	502	1800

Reaction Location

A

B

LOAD LIST

Type	Name	Left Magnitude	Right Magnitude	Load Start (ft)	Load End (ft)	Load Type	Direction
Trapezoidal (lb/ft)	Trapezoidal	180	180	0	6.7	Dead	Y
Trapezoidal (lb/ft)	Trapezoidal	150	150	0	6.7	RoofLive	Y
Trapezoidal (lb/ft)	Trapezoidal	90	90	0	6.7	Dead	Y
Trapezoidal (lb/ft)	Trapezoidal	80	80	0	6.7	Live	Y
Trapezoidal (lb/ft)	Trapezoidal	30	30	0	6.7	Dead	Y
Self Weight (lb/ft)	-	7.38	7.38	0	6.7	Dead	Y

PASS

DATE:	3/24/2023	COMPANY:	Architects Northwest
STRUCALC BUILD:	StruCalc Plus	DESIGNED BY:	Sarah Weight
CUSTOMER:	Phan-Nguyen	REVIEWED BY:	Sarah Weight
PROJ. ADDRESS:	-- Mercer Island, WA	PROJECT NAME:	Phan-Nguyen
LEVEL:	StruCalc Members	LOADING:	ASD
MEMBER NAME:	M07.OT1 - OFFICE 2 WDO HDR	CODE:	2018 International Building Code
MEMBER TYPE:	FLOOR BEAM	NDS:	2018 NDS
MATERIAL:	Solid Sawn		
Douglas Fir-Larch	No. 2	(1) 3.5 X 9.25	DRY

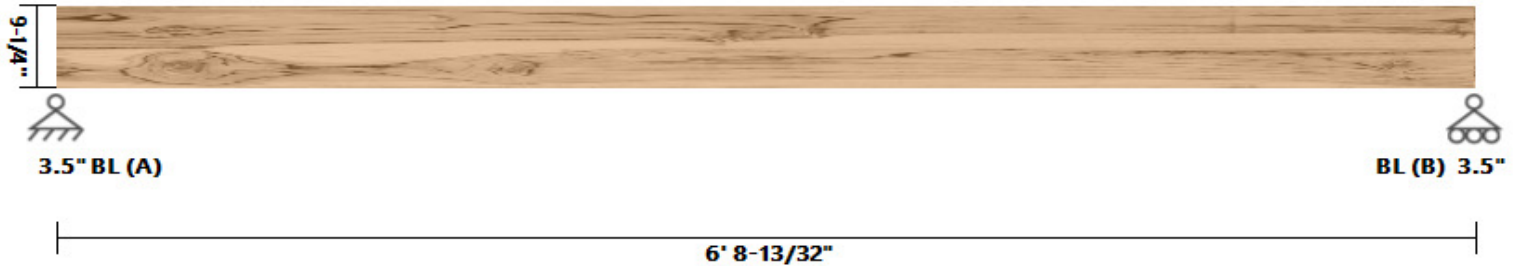
M07.OT1 - OFFICE 2 WDO HDR DIAGRAM**BEAM PROPERTIES**

Start (ft): 0 End (ft): 6.7 Member Slope: 0/12 Actual Length (ft): 6.7

Area	I _x	I _y	BSW	Lams	G	K _{cr}
(in ²)	(in ⁴)	(in ⁴)	(lbf/ft)			Creep Factor
32.38	230.84	33.05	7.38	1	0.5	1

STRENGTH PROPERTIES

	F _b (psi)	F _t (psi)	F _v (psi)	F _c (psi)	F _{c⊥} (psi)	E (psi) x10 ³	E _{min} (psi) x10 ³
Base Values	900	575	180	1350	625	1600	580
Adjusted Values	1080	632	180	1350	625	1600	580
C _M	1	1	1	1	1	1	1
C _T	1	1	1	1	1	1	1
C _i	1	1	1	1	1	1	1
C _F	1.2	1.1	1	1	1	1	1

Bending Adjustment Factors C_{fu} = 1 C_r = 1**BEAM DATA**

Span	Length (ft)	Unbraced Length (ft)		Beam End				
		Top	Bottom	Elev. Diff (ft)	CL(Top)	CL(Bottom)	CL(Left)	CL(Right)
1	6.7	4	6.7	0	0.99	0.99	1.00	1.00

PASS-FAIL

	PASS/FAIL	MAGNITUDE	STRENGTH	LOCATION (ft)	LOAD COMBO	DURATION FACTOR CD
Shear Stress Y (psi)	PASS (45.7%)	97.8	180.0	6.7	D+L	1
Bending Stress Y (psi)	PASS (20.0%)	857.9	1073.0	4.15	D+L	1
Deflection (in)	PASS (65.9%)	0.076 (=L/1056)	0.223 (=L/360)	3.48	D+L	
Bearing Stress (psi)	PASS (72.4%)	172.3	625.0	6.7	D+L	1

REACTIONS

Units for V: lbf Units for M: lbf-ft

Y axis	DEAD	LIVE	LIVE ROOF	TOTAL
A	1231	474	261	1966
B	1231	880	261	2372

Reaction Location

A

B

LOAD LIST

Type	Name	Left Magnitude	Right Magnitude	Load Start (ft)	Load End (ft)	Load Type	Direction
Trapezoidal (lb/ft)	Trapezoidal	216	216	0	6.7	Dead	Y
Trapezoidal (lb/ft)	Trapezoidal	78	78	0	6.7	RoofLive	Y
Trapezoidal (lb/ft)	Trapezoidal	108	108	0	6.7	Dead	Y
Trapezoidal (lb/ft)	Trapezoidal	40	40	0	6.7	Live	Y
Trapezoidal (lb/ft)	Trapezoidal	36	36	0	6.7	Dead	Y
Axial (lb)	Axial	1086	1086	4.6	0	Live	Y
Self Weight (lb/ft)	-	7.38	7.38	0	6.7	Dead	Y

PASS

DATE:	3/24/2023	COMPANY:	Architects Northwest
STRUCALC BUILD:	StruCalc Plus	DESIGNED BY:	Sarah Weight
CUSTOMER:	Phan-Nguyen	REVIEWED BY:	Sarah Weight
PROJ. ADDRESS:	-- Mercer Island, WA	PROJECT NAME:	Phan-Nguyen
LEVEL:	StruCalc Members	LOADING:	ASD
MEMBER NAME:	M07.OT2 - OFFICE 2 WDO HDR	CODE:	2018 International Building Code
MEMBER TYPE:	FLOOR BEAM	NDS:	2018 NDS
MATERIAL:	Solid Sawn		
Douglas Fir-Larch	No. 2	(1) 3.5 X 9.25	DRY

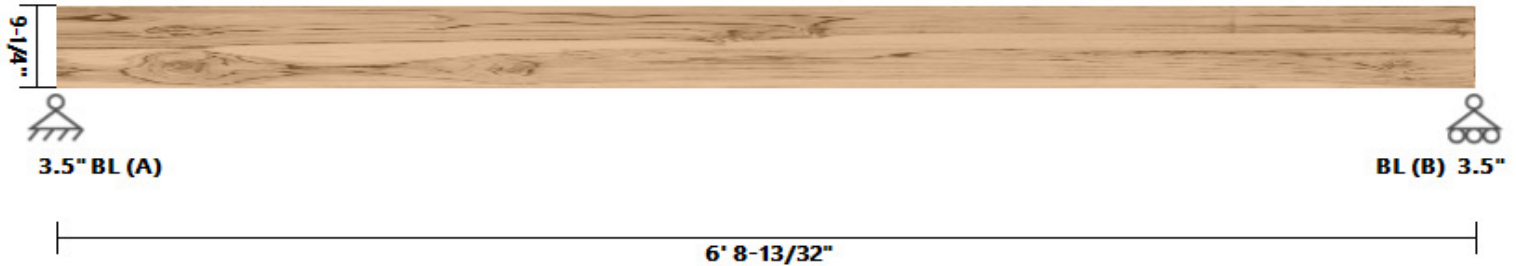
M07.OT2 - OFFICE 2 WDO HDR DIAGRAM**BEAM PROPERTIES**

Start (ft): 0 End (ft): 6.7 Member Slope: 0/12 Actual Length (ft): 6.7

Area	I _x	I _y	BSW	Lams	G	K _{cr}
(in ²)	(in ⁴)	(in ⁴)	(lbf/ft)			Creep Factor
32.38	230.84	33.05	7.38	1	0.5	1

STRENGTH PROPERTIES

	F _b (psi)	F _t (psi)	F _v (psi)	F _c (psi)	F _{c⊥} (psi)	E (psi) x10 ³	E _{min} (psi) x10 ³
Base Values	900	575	180	1350	625	1600	580
Adjusted Values	1080	632	180	1350	625	1600	580
C _M	1	1	1	1	1	1	1
C _T	1	1	1	1	1	1	1
C _i	1	1	1	1	1	1	1
C _F	1.2	1.1	1	1	1	1	1

Bending Adjustment Factors C_{fu} = 1 C_r = 1**BEAM DATA**

Span	Length (ft)	Unbraced Length (ft)		Beam End				
		Top	Bottom	Elev. Diff (ft)	CL(Top)	CL(Bottom)	CL(Left)	CL(Right)
1	6.7	4	6.7	0	0.99	0.99	1.00	1.00

PASS-FAIL

	PASS/FAIL	MAGNITUDE	STRENGTH	LOCATION (ft)	LOAD COMBO	DURATION FACTOR CD
Shear Stress Y (psi)	PASS (64.8%)	57.0	162.0	6.7	D	0.9
Bending Stress Y (psi)	PASS (48.7%)	495.6	966.4	3.35	D	0.9
Deflection (in)	PASS (75.5%)	0.055 (=L/1470)	0.223 (=L/360)	3.35	D+Lr	
Bearing Stress (psi)	PASS (80.5%)	121.8	625.0	6.7	D+Lr	1.25

REACTIONS

Units for V: lbf Units for M: lbf-ft

Y axis	DEAD	LIVE	LIVE ROOF	TOTAL
A	1231	-206	261	1286
B	1231	-612	261	880

Reaction Location

A

B

LOAD LIST

Type	Name	Left Magnitude	Right Magnitude	Load Start (ft)	Load End (ft)	Load Type	Direction
Trapezoidal (lb/ft)	Trapezoidal	216	216	0	6.7	Dead	Y
Trapezoidal (lb/ft)	Trapezoidal	78	78	0	6.7	RoofLive	Y
Trapezoidal (lb/ft)	Trapezoidal	108	108	0	6.7	Dead	Y
Trapezoidal (lb/ft)	Trapezoidal	40	40	0	6.7	Live	Y
Trapezoidal (lb/ft)	Trapezoidal	36	36	0	6.7	Dead	Y
Axial (lb)	Axial	-1086	-1086	4.6	0	Live	Y
Self Weight (lb/ft)	-	7.38	7.38	0	6.7	Dead	Y

PASS

DATE:	3/24/2023	COMPANY:	Architects Northwest
STRUCALC BUILD:	StruCalc Plus	DESIGNED BY:	Sarah Weight
CUSTOMER:	Phan-Nguyen	REVIEWED BY:	Sarah Weight
PROJ. ADDRESS:	-- Mercer Island, WA	PROJECT NAME:	Phan-Nguyen
LEVEL:	StruCalc Members	LOADING:	ASD
MEMBER NAME:	M08 - OFFICE 1 WDO HDR	CODE:	2018 International Building Code
MEMBER TYPE:	FLOOR BEAM	NDS:	2018 NDS
MATERIAL:	Solid Sawn		
Douglas Fir-Larch	No. 2	(1) 5.5 X 11.5	DRY

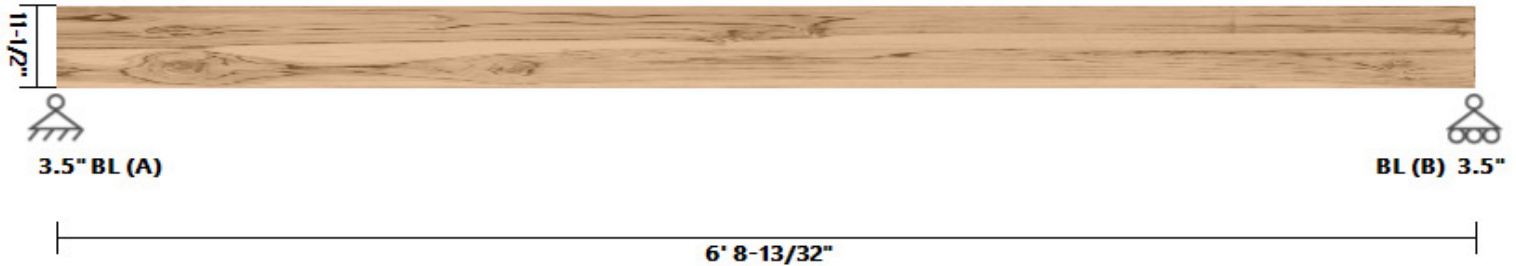
M08 - OFFICE 1 WDO HDR DIAGRAM**BEAM PROPERTIES**

Start (ft): 0 End (ft): 6.7 Member Slope: 0/12 Actual Length (ft): 6.7

Area	I _x	I _y	BSW	Lams	G	K _{cr}
(in ²)	(in ⁴)	(in ⁴)	(lbf/ft)			Creep Factor
63.25	697.07	159.44	14.43	1	0.5	1

STRENGTH PROPERTIES

	F _b (psi)	F _t (psi)	F _v (psi)	F _c (psi)	F _{c⊥} (psi)	E (psi) x10 ³	E _{min} (psi) x10 ³
Base Values	875	425	170	600	625	1300	470
Adjusted Values	875	425	170	600	625	1300	470
C _M	1	1	1	1	1	1	1
C _T	1	1	1	1	1	1	1
C _i	1	1	1	1	1	1	1
C _F	1	1	1	1	1	1	1

Bending Adjustment Factors C_{fu} = 1 C_r = 1**BEAM DATA**

Span	Length (ft)	Unbraced Length (ft)		Beam End				
		Top	Bottom	Elev. Diff (ft)	CL(Top)	CL(Bottom)	CL(Left)	CL(Right)
1	6.7	4	6.7	0	1.00	0.99	1.00	1.00

PASS-FAIL

	PASS/FAIL	MAGNITUDE	STRENGTH	LOCATION (ft)	LOAD COMBO	DURATION FACTOR CD
Shear Stress Y (psi)	PASS (67.9%)	68.2	212.5	0	D+Lr	1.25
Bending Stress Y (psi)	PASS (45.5%)	593.9	1089.5	3.22	D+Lr	1.25
Deflection (in)	PASS (78.0%)	0.049 (=L/1634)	0.223 (=L/360)	3.35	D+Lr	
Bearing Stress (psi)	PASS (76.1%)	149.5	625.0	0	D+Lr	1.25

REACTIONS

Units for V: lbf Units for M: lbf-ft

Y axis	DEAD	LIVE	LIVE ROOF	TOTAL
A	1559	268	1318	3145
B	1533	268	1277	3078

Reaction Location

A

B

LOAD LIST

Type	Name	Left Magnitude	Right Magnitude	Load Start (ft)	Load End (ft)	Load Type	Direction
Trapezoidal (lbf/ft)	Trapezoidal	180	180	0	6.7	Dead	Y
Trapezoidal (lbf/ft)	Trapezoidal	250	250	0	6.7	RoofLive	Y
Trapezoidal (lbf/ft)	Trapezoidal	150	150	0	6.7	Dead	Y
Trapezoidal (lbf/ft)	Trapezoidal	80	80	0	6.7	Live	Y
Trapezoidal (lbf/ft)	Trapezoidal	30	30	0	6.7	Dead	Y
Self Weight (lbf/ft)	-	14.43	14.43	0	6.7	Dead	Y

LINKED LOAD LIST

Type	Left Magnitude	Right Magnitude	Load Start (ft)	Load End (ft)	Load Type	Direction
Point (lbf)	582.7797	-	3.2	-	Dead	Y
Point (lbf)	920.5003	-	3.2	-	RoofLive	Y

DATE:	3/24/2023	COMPANY:	Architects Northwest		
STRUCALC BUILD:	StruCalc Plus	DESIGNED BY:	Sarah Weight		
CUSTOMER:	Phan-Nguyen	REVIEWED BY:	Sarah Weight		
PROJ. ADDRESS:	-- Mercer Island, WA	PROJECT NAME:	Phan-Nguyen		
LEVEL:	StruCalc Members	LOADING:	ASD		
MEMBER NAME:	M09 - ENTRY DECK BEAM	CODE:	2018 International Building Code		
MEMBER TYPE:	FLOOR BEAM	NDS:	2018 NDS		
MATERIAL:	Solid Sawn				
Douglas Fir-Larch	No. 2	(1) 5.5 X 11.5	DRY	INCISED	

M09 - ENTRY DECK BEAM DIAGRAM

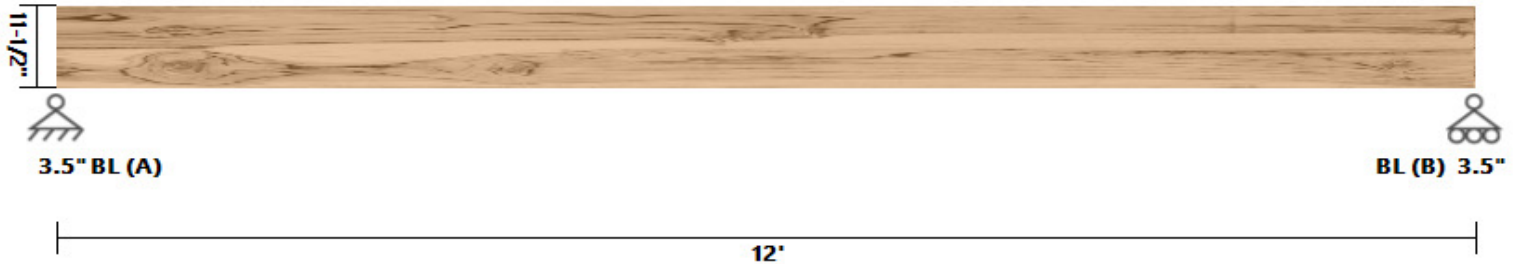

BEAM PROPERTIES

Start (ft): 0 End (ft): 12 Member Slope: 0/12 Actual Length (ft): 12

Area	I _x	I _y	BSW	Lams	G	K _{cr}
(in ²)	(in ⁴)	(in ⁴)	(lbf/ft)			Creep Factor
63.25	697.07	159.44	14.43	1	0.5	1

STRENGTH PROPERTIES

	F _b (psi)	F _t (psi)	F _v (psi)	F _c (psi)	F _{c⊥} (psi)	E (psi) x10 ³	E _{min} (psi) x10 ³
Base Values	875	425	170	600	625	1300	470
Adjusted Values	700	340	136	480	625	1235	446
C _M	1	1	1	1	1	1	1
C _T	1	1	1	1	1	1	1
C _i	0.8	0.8	0.8	0.8	1	0.95	0.95
C _F	1	1	1	1	1	1	1

Bending Adjustment Factors C_{fu} = 1 C_r = 1

BEAM DATA

Span	Length (ft)	Unbraced Length (ft)		Beam End				
		Top	Bottom	Elev. Diff (ft)	CL(Top)	CL(Bottom)	CL(Left)	CL(Right)
1	12	2	12	0	1.00	0.99	1.00	1.00

PASS-FAIL

	PASS/FAIL	MAGNITUDE	STRENGTH	LOCATION (ft)	LOAD COMBO	DURATION FACTOR	CD
Shear Stress Y (psi)	PASS (67.0%)	44.9	136.0	12	D+L	1	
Bending Stress Y (psi)	PASS (19.6%)	562.0	699.1	6	D+L	1	
Deflection (in)	PASS (53.4%)	0.140 (=L/1030)	0.300 (=L/480)	6	L		
Bearing Stress (psi)	PASS (84.3%)	98.3	625.0	0	D+L	1	

REACTIONS

Units for V: lbf Units for M: lbf-ft

Y axis	DEAD	LIVE	TOTAL
A	345	1548	1893
B	345	1548	1893

Reaction Location

A

B

LOAD LIST

Type	Name	Left Magnitude	Right Magnitude	Load Start (ft)	Load End (ft)	Load Type	Direction
Trapezoidal (lb/ft)	Trapezoidal	258	258	0	12	Live	Y
Trapezoidal (lb/ft)	Trapezoidal	43	43	0	12	Dead	Y
Self Weight (lb/ft)	-	14.43	14.43	0	12	Dead	Y

DATE:	3/24/2023	COMPANY:	Architects Northwest
STRUCALC BUILD:	StruCalc Plus	DESIGNED BY:	Sarah Weight
CUSTOMER:	Phan-Nguyen	REVIEWED BY:	Sarah Weight
PROJ. ADDRESS:	-- Mercer Island, WA	PROJECT NAME:	Phan-Nguyen
LEVEL:	StruCalc Members	LOADING:	ASD
MEMBER NAME:	C01 - COL at R01b	CODE:	2018 International Building Code
MEMBER TYPE:	COLUMN	NDS:	2018 NDS
MATERIAL:	Solid Sawn		
Douglas Fir-Larch	No. 2	(3) 1.5 X 5.5	DRY

C01 - COL at R01b DIAGRAM

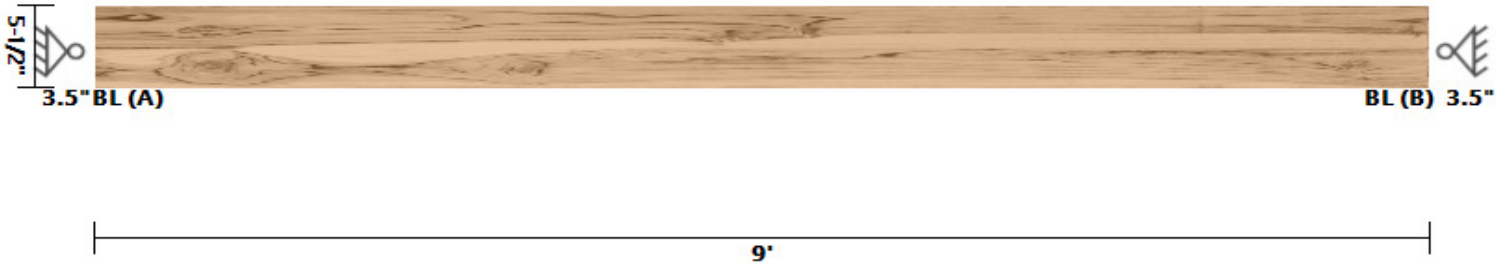

COLUMN PROPERTIES

Start(ft) 0 End(ft): 9

Area	I _x	I _y	BSW	Lams	G	K _{cr}
(in ²)	(in ⁴)	(in ⁴)	(lb/ft)			Creep Factor
24.75	62.39	41.77	5.64	3	0.5	1

STRENGTH PROPERTIES

	F _b (psi)	F _t (psi)	F _v (psi)	F _c (psi)	F _{c⊥} (psi)	E (psi) x10 ³	E _{min} (psi) x10 ³
Base Values	900	575	180	1350	625	1600	580
Adjusted Values	1170	748	180	1485	625	1600	580
C _M	1	1	1	1	1	1	1
C _T	1	1	1	1	1	1	1
C _i	1	1	1	1	1	1	1
C _F	1.3	1.3	1	1.1	1	1	1

Bending Adjustment Factors C_{fu} = 1 C_r = 1

COLUMN DATA

Span	Length (ft)	Unbraced Length (ft)		Column End					
		X	Y	Offset	CP	Ke(X Axis)	Ke(Y Axis)	KeL/d (X Axis)	KeL/d (Y Axis)
1	9	9	9	0	0.38	1.00	1.00	19.64	24

PASS-FAIL

	PASS/FAIL	MAGNITUDE	STRENGTH	LOCATION (ft)	LOAD COMBO	DURATION FACTOR CD
Compressive Stress (psi)	PASS (99.0%)	5.0	513.1	0	D	0.9

REACTIONS

Units for V: lbf Units for M: lbf-ft

Z axis	DEAD	TOTAL
A	123	123
B	0	0

Reaction Location

A B

LOAD LIST

Type	Name	Left Magnitude	Right Magnitude	Load Start (ft)	Load End (ft)	Load Type	Direction
Self Weight (lb/ft)	-	5.64	5.64	0	9	Dead	Z

LINKED LOAD LIST

Type	Left Magnitude	Right Magnitude	Load Start (ft)	Load End (ft)	Load Type	Direction
Axial (lbf)	-72.65992	-72.65992	9	9	Dead	Z

DATE:	3/24/2023	COMPANY:	Architects Northwest
STRUCALC BUILD:	StruCalc Plus	DESIGNED BY:	Sarah Weight
CUSTOMER:	Phan-Nguyen	REVIEWED BY:	Sarah Weight
PROJ. ADDRESS:	--	PROJECT NAME:	Phan-Nguyen
	, Mercer Island, WA		
LEVEL:	StruCalc Members	LOADING:	ASD
MEMBER NAME:	C02 - COL at GT7a	CODE:	2018 International Building Code
MEMBER TYPE:	COLUMN	NDS:	2018 NDS
MATERIAL:	Solid Sawn		
Douglas Fir-Larch	No. 2	(3) 1.5 X 5.5	DRY

C02 - COL at GT7a DIAGRAM

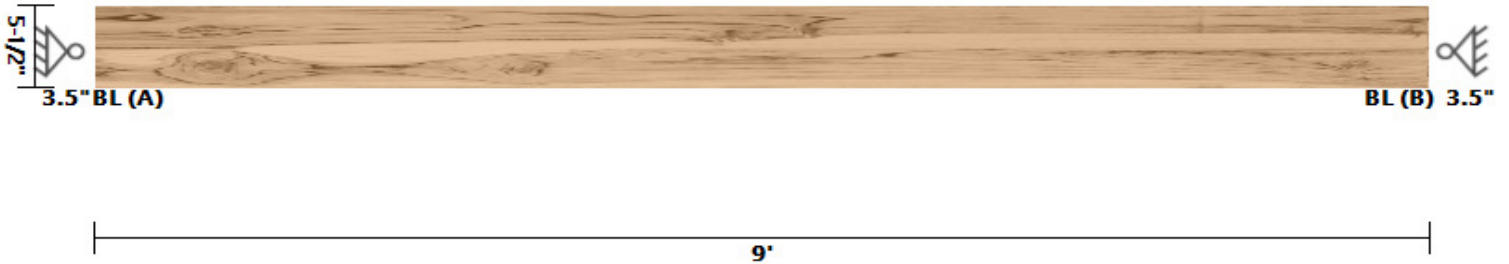

COLUMN PROPERTIES

Start(ft) 0 End(ft): 9

Area	Ix	Iy	BSW	Lams	G	Kcr
(in ²)	(in ⁴)	(in ⁴)	(lbf/ft)			Creep Factor
24.75	62.39	41.77	5.64	3	0.5	1

STRENGTH PROPERTIES

	Fb (psi)	Ft (psi)	Fv (psi)	Fc (psi)	Fc⊥ (psi)	E (psi) x10 ³	Emin (psi) x10 ³
Base Values	900	575	180	1350	625	1600	580
Adjusted Values	1170	748	180	1485	625	1600	580
C _M	1	1	1	1	1	1	1
C _T	1	1	1	1	1	1	1
C _i	1	1	1	1	1	1	1
C _F	1.3	1.3	1	1.1	1	1	1

Bending Adjustment Factors C_{fu} = 1 C_r = 1

COLUMN DATA

Span	Length (ft)	Unbraced Length (ft)		Column End					
		X	Y	Offset	CP	Ke(X Axis)	Ke(Y Axis)	KeL/d (X Axis)	KeL/d (Y Axis)
1	9	9	9	0	0.30	1.00	1.00	19.64	24

PASS-FAIL

	PASS/FAIL	MAGNITUDE	STRENGTH	LOCATION (ft)	LOAD COMBO	DURATION FACTOR CD
Deflection (in)	PASS (99.6%)	0.003 (=L/41538)	0.600 (=L/180)	9	Lr	
Compressive Stress (psi)	PASS (87.9%)	66.5	549.2	0	D+Lr	1.25

REACTIONS

Units for V: lbf Units for M: lbf-ft

Z axis	DEAD	LIVE ROOF	TOTAL
A	674	971	1645
B	0	0	0

Reaction Location



LOAD LIST

Type	Name	Left Magnitude	Right Magnitude	Load Start (ft)	Load End (ft)	Load Type	Direction
Self Weight (lbf/ft)	-	5.64	5.64	0	9	Dead	Z

LINKED LOAD LIST

Type	Left Magnitude	Right Magnitude	Load Start (ft)	Load End (ft)	Load Type	Direction
Axial (lbf)	-623.3502	-623.3502	9	9	Dead	Z
Axial (lbf)	-971.3389	-971.3389	9	9	RoofLive	Z

PASS

DATE:	3/24/2023	COMPANY:	Architects Northwest
STRUCALC BUILD:	StruCalc Plus	DESIGNED BY:	Sarah Weight
CUSTOMER:	Phan-Nguyen	REVIEWED BY:	Sarah Weight
PROJ. ADDRESS:	--	PROJECT NAME:	Phan-Nguyen
	, Mercer Island, WA		
LEVEL:	StruCalc Members	LOADING:	ASD
MEMBER NAME:	C03 - COL at GT8a	CODE:	2018 International Building Code
MEMBER TYPE:	COLUMN	NDS:	2018 NDS
MATERIAL:	Solid Sawn		
Douglas Fir-Larch	No. 2	(1) 5.5 X 5.5	DRY

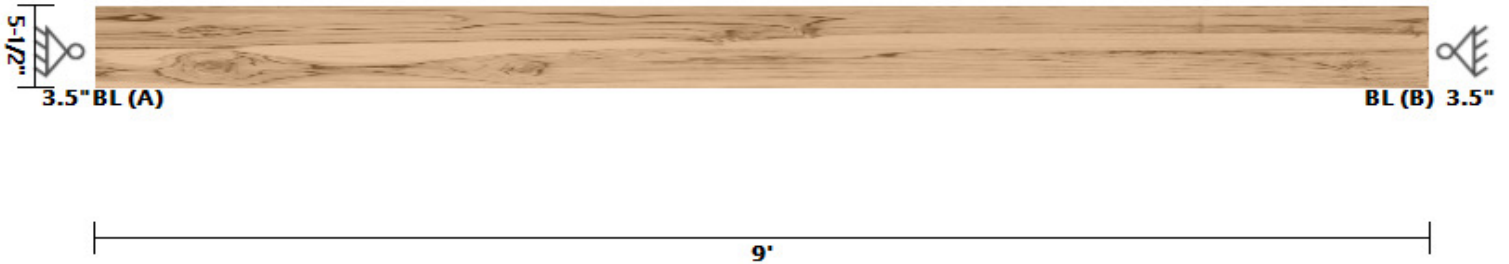
C03 - COL at GT8a DIAGRAM**COLUMN PROPERTIES**

Start(ft) 0 End(ft): 9

Area	I _x	I _y	BSW	Lams	G	K _{cr}
(in ²)	(in ⁴)	(in ⁴)	(lbf/ft)			Creep Factor
30.25	76.26	76.26	6.9	1	0.5	1

STRENGTH PROPERTIES

	F _b (psi)	F _t (psi)	F _v (psi)	F _c (psi)	F _{c⊥} (psi)	E (psi) x10 ³	E _{min} (psi) x10 ³
Base Values	750	475	170	700	625	1300	470
Adjusted Values	750	475	170	700	625	1300	470
C _M	1	1	1	1	1	1	1
C _T	1	1	1	1	1	1	1
C _i	1	1	1	1	1	1	1
C _F	1	1	1	1	1	1	1

Bending Adjustment Factors C_{fu} = 1 C_r = 1**COLUMN DATA**

Span	Length (ft)	Unbraced Length (ft)		Column End					
		X	Y	Offset	CP	Ke(X Axis)	Ke(Y Axis)	KeL/d (X Axis)	KeL/d (Y Axis)
1	9	9	9	0	0.74	1.00	1.00	19.64	19.64

PASS-FAIL

	PASS/FAIL	MAGNITUDE	STRENGTH	LOCATION (ft)	LOAD COMBO	DURATION FACTOR CD
Deflection (in)	PASS (99.9%)	0.001 (=L/154286)	0.600 (=L/180)	9	Lr	
Compressive Stress (psi)	PASS (97.2%)	17.8	643.7	0	D+Lr	1.25

REACTIONS

Units for V: lbf Units for M: lbf-ft

Z axis	DEAD	LIVE ROOF	TOTAL
A	275	263	538
B	0	0	0

Reaction Location

**LOAD LIST**

Type	Name	Left Magnitude	Right Magnitude	Load Start (ft)	Load End (ft)	Load Type	Direction
Self Weight (lbf/ft)	-	6.9	6.9	0	9	Dead	Z

LINKED LOAD LIST

Type	Left Magnitude	Right Magnitude	Load Start (ft)	Load End (ft)	Load Type	Direction
Axial (lbf)	-212.8614	-212.8614	9	9	Dead	Z
Axial (lbf)	-263.2002	-263.2002	9	9	RoofLive	Z

DATE:	3/24/2023	COMPANY:	Architects Northwest
STRUCALC BUILD:	StruCalc Plus	DESIGNED BY:	Sarah Weight
CUSTOMER:	Phan-Nguyen	REVIEWED BY:	Sarah Weight
PROJ. ADDRESS:	--	PROJECT NAME:	Phan-Nguyen
	, Mercer Island, WA		
LEVEL:	StruCalc Members	LOADING:	ASD
MEMBER NAME:	C04 - COL at GT11a	CODE:	2018 International Building Code
MEMBER TYPE:	COLUMN	NDS:	2018 NDS
MATERIAL:	Solid Sawn		
Douglas Fir-Larch	No. 2	(3) 1.5 X 5.5	DRY

C04 - COL at GT11a DIAGRAM

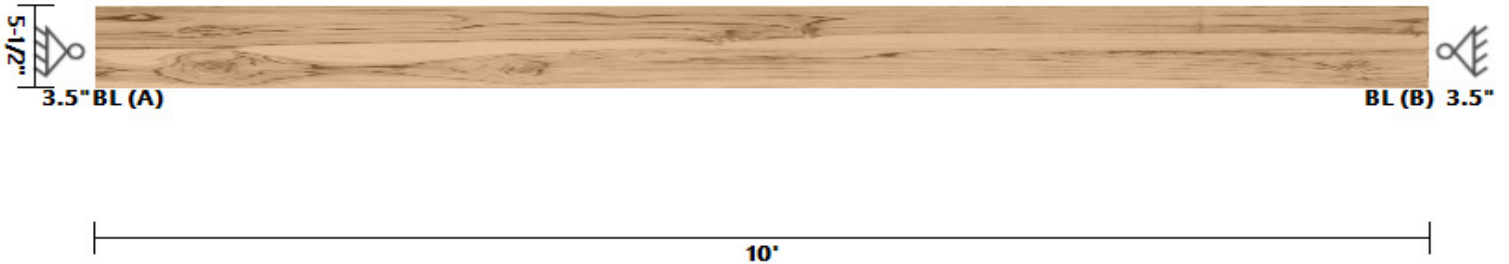

COLUMN PROPERTIES

Start(ft) 0 End(ft): 10

Area	Ix	Iy	BSW	Lams	G	Kcr
(in ²)	(in ⁴)	(in ⁴)	(lbf/ft)			Creep Factor
24.75	62.39	41.77	5.64	3	0.5	1

STRENGTH PROPERTIES

	Fb (psi)	Ft (psi)	Fv (psi)	Fc (psi)	Fc⊥ (psi)	E (psi) x10 ³	Emin (psi) x10 ³
Base Values	900	575	180	1350	625	1600	580
Adjusted Values	1170	748	180	1485	625	1600	580
C _M	1	1	1	1	1	1	1
C _T	1	1	1	1	1	1	1
C _i	1	1	1	1	1	1	1
C _F	1.3	1.3	1	1.1	1	1	1

Bending Adjustment Factors C_{fu} = 1 C_r = 1

COLUMN DATA

Span	Length (ft)	Unbraced Length (ft)		Column End					
		X	Y	Offset	CP	Ke(X Axis)	Ke(Y Axis)	KeL/d (X Axis)	KeL/d (Y Axis)
1	10	10	10	0	0.25	1.00	1.00	21.82	26.67

PASS-FAIL

	PASS/FAIL	MAGNITUDE	STRENGTH	LOCATION (ft)	LOAD COMBO	DURATION FACTOR CD
Deflection (in)	PASS (99.4%)	0.004 (=L/27908)	0.667 (=L/180)	10	Lr	
Compressive Stress (psi)	PASS (79.2%)	95.2	457.9	0	D+Lr	1.25

REACTIONS

Units for V: lbf Units for M: lbf-ft

Z axis	DEAD	LIVE ROOF	TOTAL
A	939	1418	2357
B	0	0	0

Reaction Location



LOAD LIST

Type	Name	Left Magnitude	Right Magnitude	Load Start (ft)	Load End (ft)	Load Type	Direction
Self Weight (lbf/ft)	-	5.64	5.64	0	10	Dead	Z

LINKED LOAD LIST

Type	Left Magnitude	Right Magnitude	Load Start (ft)	Load End (ft)	Load Type	Direction
Axial (lbf)	-882.3273	-882.3273	10	10	Dead	Z
Axial (lbf)	-1418.336	-1418.336	10	10	RoofLive	Z

PASS

DATE:	3/24/2023	COMPANY:	Architects Northwest
STRUCALC BUILD:	StruCalc Plus	DESIGNED BY:	Sarah Weight
CUSTOMER:	Phan-Nguyen	REVIEWED BY:	Sarah Weight
PROJ. ADDRESS:	-- Mercer Island, WA	PROJECT NAME:	Phan-Nguyen
LEVEL:	StruCalc Members	LOADING:	ASD
MEMBER NAME:	C05 - COL at GT12a	CODE:	2018 International Building Code
MEMBER TYPE:	COLUMN	NDS:	2018 NDS
MATERIAL:	Solid Sawn		
Douglas Fir-Larch	No. 2	(3) 1.5 X 5.5	DRY

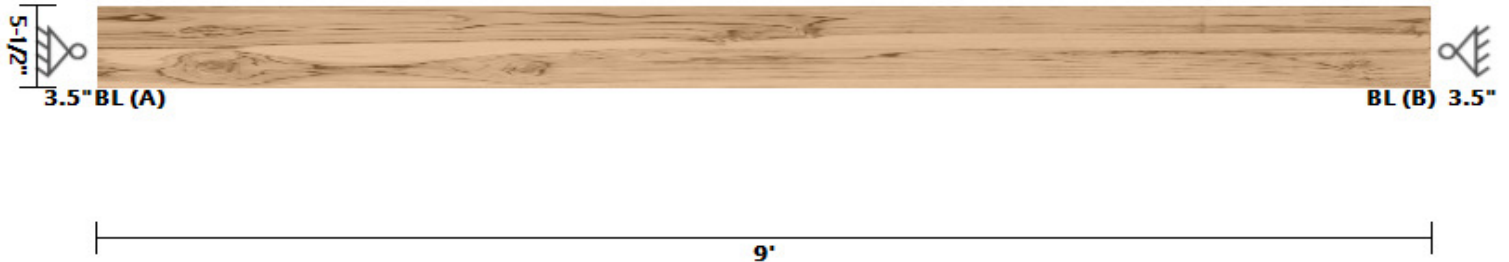
C05 - COL at GT12a DIAGRAM**COLUMN PROPERTIES**

Start(ft) 0 End(ft): 9

Area	I _x	I _y	BSW	Lams	G	K _{cr}
(in ²)	(in ⁴)	(in ⁴)	(lbf/ft)			Creep Factor
24.75	62.39	41.77	5.64	3	0.5	1

STRENGTH PROPERTIES

	F _b (psi)	F _t (psi)	F _v (psi)	F _c (psi)	F _{c⊥} (psi)	E (psi) x10 ³	E _{min} (psi) x10 ³
Base Values	900	575	180	1350	625	1600	580
Adjusted Values	1170	748	180	1485	625	1600	580
C _M	1	1	1	1	1	1	1
C _T	1	1	1	1	1	1	1
C _i	1	1	1	1	1	1	1
C _F	1.3	1.3	1	1.1	1	1	1

Bending Adjustment Factors C_{fu} = 1 C_r = 1**COLUMN DATA**

Span	Length (ft)	Unbraced Length (ft)		Column End					
		X	Y	Offset	CP	Ke(X Axis)	Ke(Y Axis)	KeL/d (X Axis)	KeL/d (Y Axis)
1	9	9	9	0	0.30	1.00	1.00	19.64	24

PASS-FAIL

	PASS/FAIL	MAGNITUDE	STRENGTH	LOCATION (ft)	LOAD COMBO	DURATION FACTOR CD
Deflection (in)	PASS (99.4%)	0.004 (=L/27692)	0.600 (=L/180)	9	Lr	
Compressive Stress (psi)	PASS (82.7%)	95.0	549.2	0	D+Lr	1.25

REACTIONS

Units for V: lbf Units for M: lbf-ft

Z axis	DEAD	LIVE ROOF	TOTAL
A	933	1418	2351
B	0	0	0

Reaction Location

**LOAD LIST**

Type	Name	Left Magnitude	Right Magnitude	Load Start (ft)	Load End (ft)	Load Type	Direction
Self Weight (lbf/ft)	-	5.64	5.64	0	9	Dead	Z

LINKED LOAD LIST

Type	Left Magnitude	Right Magnitude	Load Start (ft)	Load End (ft)	Load Type	Direction
Axial (lbf)	-882.3273	-882.3273	9	9	Dead	Z
Axial (lbf)	-1418.336	-1418.336	9	9	RoofLive	Z

PASS

DATE:	3/24/2023	COMPANY:	Architects Northwest
STRUCALC BUILD:	StruCalc Plus	DESIGNED BY:	Sarah Weight
CUSTOMER:	Phan-Nguyen	REVIEWED BY:	Sarah Weight
PROJ. ADDRESS:	-- Mercer Island, WA	PROJECT NAME:	Phan-Nguyen
LEVEL:	StruCalc Members	LOADING:	ASD
MEMBER NAME:	C06 - COL at GT13a	CODE:	2018 International Building Code
MEMBER TYPE:	COLUMN	NDS:	2018 NDS
MATERIAL:	Solid Sawn		
Douglas Fir-Larch	No. 2	(3) 1.5 X 5.5	DRY

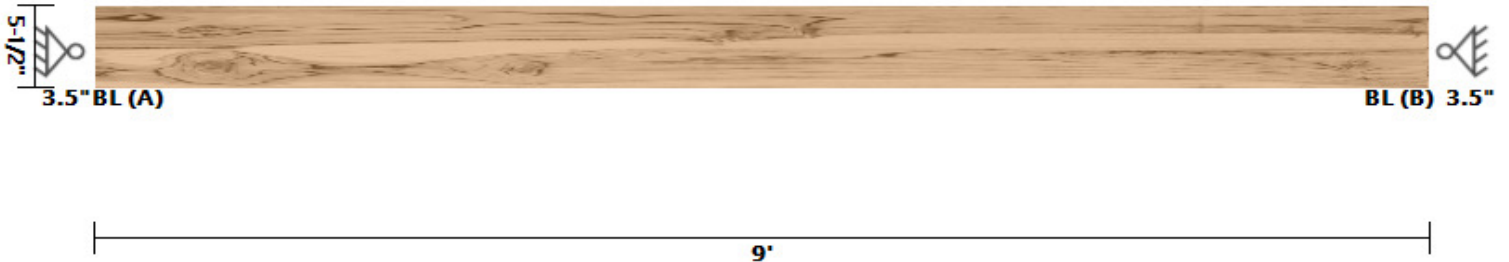
C06 - COL at GT13a DIAGRAM**COLUMN PROPERTIES**

Start(ft) 0 End(ft): 9

Area	I _x	I _y	BSW	Lams	G	K _{cr}
(in ²)	(in ⁴)	(in ⁴)	(lb/ft)			Creep Factor
24.75	62.39	41.77	5.64	3	0.5	1

STRENGTH PROPERTIES

	F _b (psi)	F _t (psi)	F _v (psi)	F _c (psi)	F _{c⊥} (psi)	E (psi) x10 ³	E _{min} (psi) x10 ³
Base Values	900	575	180	1350	625	1600	580
Adjusted Values	1170	748	180	1485	625	1600	580
C _M	1	1	1	1	1	1	1
C _T	1	1	1	1	1	1	1
C _i	1	1	1	1	1	1	1
C _F	1.3	1.3	1	1.1	1	1	1

Bending Adjustment Factors C_{fu} = 1 C_r = 1**COLUMN DATA**

Span	Length (ft)	Unbraced Length (ft)		Column End					
		X	Y	Offset	CP	Ke(X Axis)	Ke(Y Axis)	KeL/d (X Axis)	KeL/d (Y Axis)
1	9	9	9	0	0.38	1.00	1.00	19.64	24

PASS-FAIL

	PASS/FAIL	MAGNITUDE	STRENGTH	LOCATION (ft)	LOAD COMBO	DURATION FACTOR CD
Compressive Stress (psi)	PASS (99.4%)	2.9	513.1	0	D	0.9

REACTIONS

Units for V: lbf Units for M: lbf-ft

Z axis	DEAD	TOTAL
A	71	71
B	0	0

Reaction Location

A

B

LOAD LIST

Type	Name	Left Magnitude	Right Magnitude	Load Start (ft)	Load End (ft)	Load Type	Direction
Self Weight (lb/ft)	-	5.64	5.64	0	9	Dead	Z

LINKED LOAD LIST

Type	Left Magnitude	Right Magnitude	Load Start (ft)	Load End (ft)	Load Type	Direction
Axial (lbf)	-20.35526	-20.35526	9	9	Dead	Z

DATE:	3/24/2023	COMPANY:	Architects Northwest
STRUCALC BUILD:	StruCalc Plus	DESIGNED BY:	Sarah Weight
CUSTOMER:	Phan-Nguyen	REVIEWED BY:	Sarah Weight
PROJ. ADDRESS:	--	PROJECT NAME:	Phan-Nguyen
	, Mercer Island, WA		
LEVEL:	StruCalc Members	LOADING:	ASD
MEMBER NAME:	C07 - COL at GT14b & HDR	CODE:	2018 International Building Code
MEMBER TYPE:	COLUMN	NDS:	2018 NDS
MATERIAL:	Solid Sawn		
Douglas Fir-Larch	No. 2	(3) 1.5 X 5.5	DRY

C07 - COL at GT14b & HDR DIAGRAM

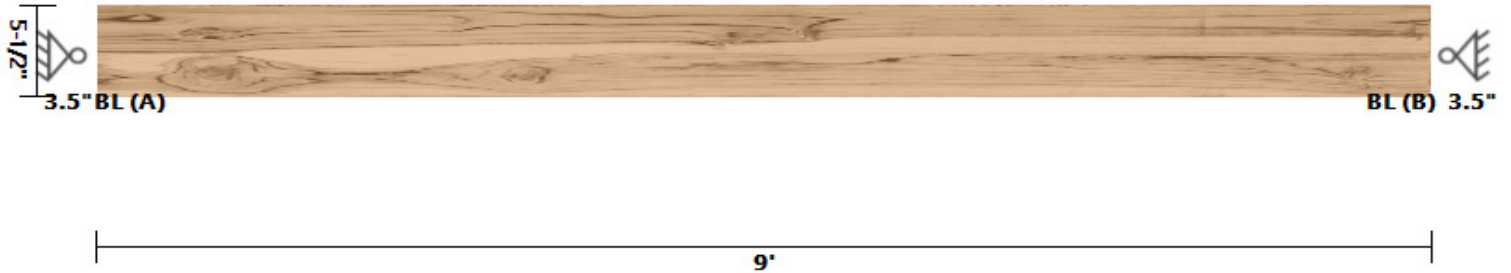

COLUMN PROPERTIES

Start(ft) 0 End(ft): 9

Area	Ix	Iy	BSW	Lams	G	Kcr
(in ²)	(in ⁴)	(in ⁴)	(lbf/ft)			Creep Factor
24.75	62.39	41.77	5.64	3	0.5	1

STRENGTH PROPERTIES

	Fb (psi)	Ft (psi)	Fv (psi)	Fc (psi)	Fc⊥ (psi)	E (psi) x10 ³	Emin (psi) x10 ³
Base Values	900	575	180	1350	625	1600	580
Adjusted Values	1170	748	180	1485	625	1600	580
C _M	1	1	1	1	1	1	1
C _T	1	1	1	1	1	1	1
C _i	1	1	1	1	1	1	1
C _F	1.3	1.3	1	1.1	1	1	1

Bending Adjustment Factors C_{fu} = 1 C_r = 1

COLUMN DATA

Span	Length (ft)	Unbraced Length (ft)		Column End					
		X	Y	Offset	CP	Ke(X Axis)	Ke(Y Axis)	KeL/d (X Axis)	KeL/d (Y Axis)
1	9	9	9	0	0.28	1.00	1.00	19.64	24

PASS-FAIL

	PASS/FAIL	MAGNITUDE	STRENGTH	LOCATION (ft)	LOAD COMBO	DURATION FACTOR CD
Deflection (in)	PASS (99.3%)	0.005 (=L/24000)	0.600 (=L/180)	9	D+L	
Compressive Stress (psi)	PASS (84.0%)	67.4	421.1	0	D+L	1

REACTIONS

Units for V: lbf Units for M: lbf-ft

Z axis	DEAD	LIVE	LIVE ROOF	TOTAL
A	775	894	194	1863
B	0	0	0	0

Reaction Location



LOAD LIST

Type	Name	Left Magnitude	Right Magnitude	Load Start (ft)	Load End (ft)	Load Type	Direction
Axial (lbf)	HDR	-894	-894	9	9	Live	Z
Axial (lbf)	HDR	-576	-576	9	9	Dead	Z
Self Weight (lbf/ft)	-	5.64	5.64	0	9	Dead	Z

LINKED LOAD LIST

Type	Left Magnitude	Right Magnitude	Load Start (ft)	Load End (ft)	Load Type	Direction
Axial (lbf)	-147.8356	-147.8356	9	9	Dead	Z
Axial (lbf)	-193.9154	-193.9154	9	9	RoofLive	Z

DATE:	3/24/2023	COMPANY:	Architects Northwest
STRUCALC BUILD:	StruCalc Plus	DESIGNED BY:	Sarah Weight
CUSTOMER:	Phan-Nguyen	REVIEWED BY:	Sarah Weight
PROJ. ADDRESS:	--	PROJECT NAME:	Phan-Nguyen
	, Mercer Island, WA		
LEVEL:	StruCalc Members	LOADING:	ASD
MEMBER NAME:	C08 - COL at GT14a	CODE:	2018 International Building Code
MEMBER TYPE:	COLUMN	NDS:	2018 NDS
MATERIAL:	Solid Sawn		
Douglas Fir-Larch	No. 2	(3) 1.5 X 5.5	DRY

C08 - COL at GT14a DIAGRAM

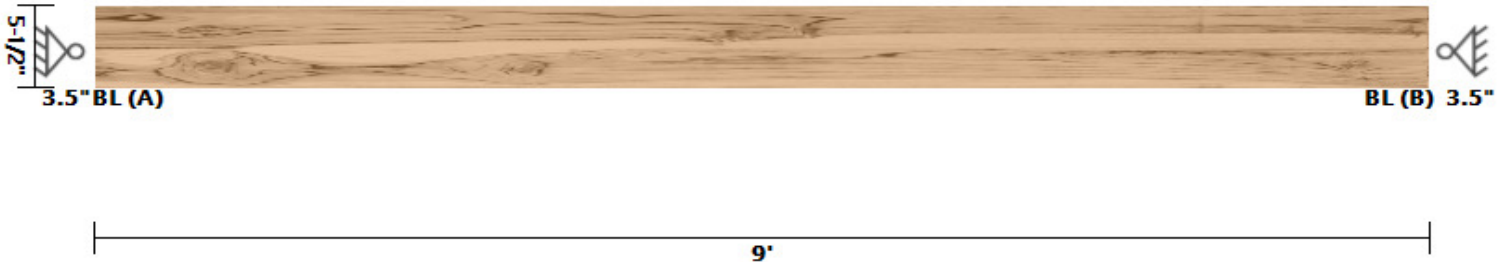

COLUMN PROPERTIES

Start(ft) 0 End(ft): 9

Area	Ix	Iy	BSW	Lams	G	Kcr
(in ²)	(in ⁴)	(in ⁴)	(lbf/ft)			Creep Factor
24.75	62.39	41.77	5.64	3	0.5	1

STRENGTH PROPERTIES

	Fb (psi)	Ft (psi)	Fv (psi)	Fc (psi)	Fc⊥ (psi)	E (psi) x10 ³	Emin (psi) x10 ³
Base Values	900	575	180	1350	625	1600	580
Adjusted Values	1170	748	180	1485	625	1600	580
C _M	1	1	1	1	1	1	1
C _T	1	1	1	1	1	1	1
C _i	1	1	1	1	1	1	1
C _F	1.3	1.3	1	1.1	1	1	1

Bending Adjustment Factors C_{fu} = 1 C_r = 1

COLUMN DATA

Span	Length (ft)	Unbraced Length (ft)		Column End					
		X	Y	Offset	CP	Ke(X Axis)	Ke(Y Axis)	KeL/d (X Axis)	KeL/d (Y Axis)
1	9	9	9	0	0.30	1.00	1.00	19.64	24

PASS-FAIL

	PASS/FAIL	MAGNITUDE	STRENGTH	LOCATION (ft)	LOAD COMBO	DURATION FACTOR CD
Deflection (in)	PASS (99.9%)	0.001 (=L/154286)	0.600 (=L/180)	9	Lr	
Compressive Stress (psi)	PASS (96.2%)	20.9	549.2	0	D+Lr	1.25

REACTIONS

Units for V: lbf Units for M: lbf-ft

Z axis	DEAD	LIVE ROOF	TOTAL
A	247	271	518
B	0	0	0

Reaction Location



LOAD LIST

Type	Name	Left Magnitude	Right Magnitude	Load Start (ft)	Load End (ft)	Load Type	Direction
Self Weight (lbf/ft)	-	5.64	5.64	0	9	Dead	Z

LINKED LOAD LIST

Type	Left Magnitude	Right Magnitude	Load Start (ft)	Load End (ft)	Load Type	Direction
Axial (lbf)	-195.8739	-195.8739	9	9	Dead	Z
Axial (lbf)	-271.4814	-271.4814	9	9	RoofLive	Z

PASS

DATE:	3/24/2023	COMPANY:	Architects Northwest
STRUCALC BUILD:	StruCalc Plus	DESIGNED BY:	Sarah Weight
CUSTOMER:	Phan-Nguyen	REVIEWED BY:	Sarah Weight
PROJ. ADDRESS:	-- Mercer Island, WA	PROJECT NAME:	Phan-Nguyen
LEVEL:	StruCalc Members	LOADING:	ASD
MEMBER NAME:	C09 - COL at R04a & R05b	CODE:	2018 International Building Code
MEMBER TYPE:	COLUMN	NDS:	2018 NDS
MATERIAL:	Glulams		
Stress Class Rated 24F-1.8E	24F-V8 DF/DF	(1) 5.125 X 6	DRY

C09 - COL at R04a & R05b DIAGRAM

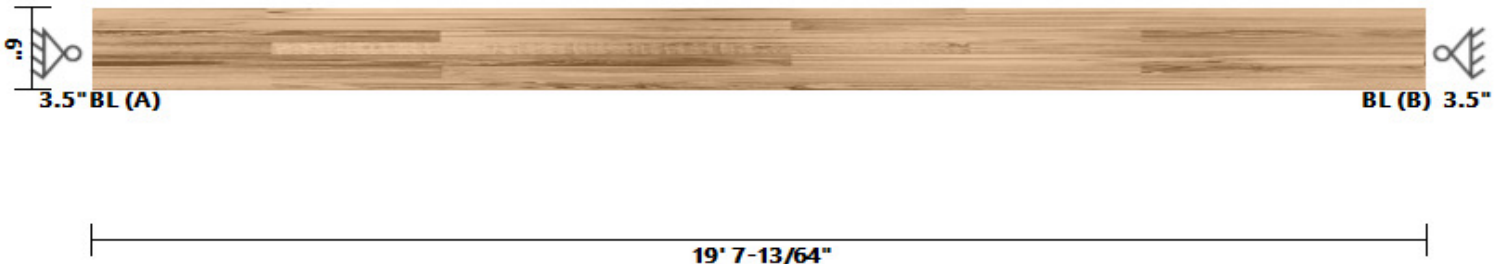

COLUMN PROPERTIES

Start(ft) 0 End(ft): 19.6

Area	Ix	Iy	BSW	Lams	G	Kcr
(in ²)	(in ⁴)	(in ⁴)	(lbf/ft)			Creep Factor
30.75	92.25	67.31	7.01	1	0.5	1

STRENGTH PROPERTIES

	Fbx+	Fbx-	Fby	Ft	Fvx	Fvy	Fc	Fc _⊥	Ex	Exmin	Ey	Eymin
	(psi)	(psi)	(psi)	(psi)	(psi)	(psi)	(psi)	(psi)	(psi)	(psi)	(psi)	(psi)
Base Values	2400	2400	1550	1100	265	230	1650	650	1800000	950000	1600000	850000
Adjusted Values	2400	2400	1674	1100	265	230	1650	650	1800000	950000	1600000	850000
C _M	1	1	1	1	1	1	1	1	1	1	1	1
C _T	1	1	1	1	1	1	1	1	1	1	1	1

Bending Adjustment Factors C_{Vr} = 1

COLUMN DATA

Span	Length (ft)	Unbraced Length (ft)		Column End		CP	Ke(X Axis)	Ke(Y Axis)	KeL/d (X Axis)	KeL/d (Y Axis)
		X	Y	Offset						
1	19.6	4	19.6	0	0.16	1.00	1.00	8	45.89	

PASS-FAIL

	PASS/FAIL	MAGNITUDE	STRENGTH	LOCATION (ft)	LOAD COMBO	DURATION FACTOR CD
Deflection (in)	PASS (99.0%)	0.013 (=L/18520)	1.307 (=L/180)	19.6	Lr	
Compressive Stress (psi)	PASS (53.4%)	151.7	325.6	0	D+Lr	1.25

REACTIONS

Units for V: lbf Units for M: lbf-ft

Z axis	DEAD	LIVE ROOF	TOTAL
A	1875	2789	4664
B	0	0	0

Reaction Location



LOAD LIST

Type	Name	Left Magnitude	Right Magnitude	Load Start (ft)	Load End (ft)	Load Type	Direction
Self Weight (lbf/ft)	-	7.01	7.01	0	19.6	Dead	Z

LINKED LOAD LIST

Type	Left Magnitude	Right Magnitude	Load Start (ft)	Load End (ft)	Load Type	Direction
Axial (lbf)	-1102.426	-1102.426	19.6	19.6	Dead	Z
Axial (lbf)	-1781.25	-1781.25	19.6	19.6	RoofLive	Z
Axial (lbf)	-634.7823	-634.7823	19.6	19.6	Dead	Z
Axial (lbf)	-1007.452	-1007.452	19.6	19.6	RoofLive	Z

PASS

DATE:	3/24/2023	COMPANY:	Architects Northwest
STRUCALC BUILD:	StruCalc Plus	DESIGNED BY:	Sarah Weight
CUSTOMER:	Phan-Nguyen	REVIEWED BY:	Sarah Weight
PROJ. ADDRESS:	--	PROJECT NAME:	Phan-Nguyen
	, Mercer Island, WA		
LEVEL:	StruCalc Members	LOADING:	ASD
MEMBER NAME:	C10 - COL at R05a	CODE:	2018 International Building Code
MEMBER TYPE:	COLUMN	NDS:	2018 NDS
MATERIAL:	Glulams		
Stress Class Rated 24F-1.8E	24F-V8 DF/DF	(1) 5.125 X 6	DRY

C10 - COL at R05a DIAGRAM

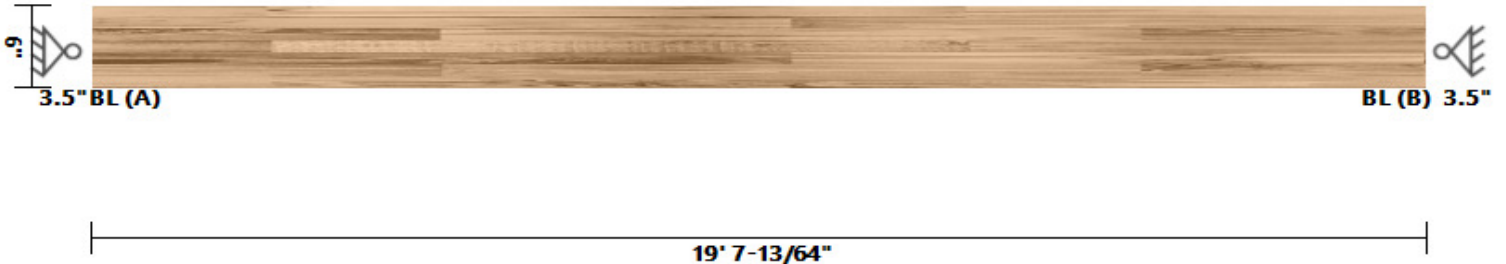

COLUMN PROPERTIES

Start(ft) 0 End(ft): 19.6

Area	Ix	Iy	BSW	Lams	G	Kcr
(in ²)	(in ⁴)	(in ⁴)	(lbf/ft)			Creep Factor
30.75	92.25	67.31	7.01	1	0.5	1

STRENGTH PROPERTIES

	Fbx+	Fbx-	Fby	Ft	Fvx	Fvy	Fc	Fc _⊥	Ex	Exmin	Ey	Eymin
	(psi)	(psi)	(psi)	(psi)	(psi)	(psi)	(psi)	(psi)	(psi)	(psi)	(psi)	(psi)
Base Values	2400	2400	1550	1100	265	230	1650	650	1800000	950000	1600000	850000
Adjusted Values	2400	2400	1674	1100	265	230	1650	650	1800000	950000	1600000	850000
C _M	1	1	1	1	1	1	1	1	1	1	1	1
C _T	1	1	1	1	1	1	1	1	1	1	1	1

Bending Adjustment Factors C_{Vr} = 1

COLUMN DATA

Span	Length (ft)	Unbraced Length (ft)		Column End		CP	Ke(X Axis)	Ke(Y Axis)	KeL/d (X Axis)	KeL/d (Y Axis)
		X	Y	Offset						
1	19.6	4	19.6	0	0.16	1.00	1.00	8	45.89	

PASS-FAIL

	PASS/FAIL	MAGNITUDE	STRENGTH	LOCATION (ft)	LOAD COMBO	DURATION FACTOR CD
Deflection (in)	PASS (99.6%)	0.005 (=L/50044)	1.307 (=L/180)	19.6	Lr	
Compressive Stress (psi)	PASS (81.9%)	59.1	325.6	0	D+Lr	1.25

REACTIONS

Units for V: lbf Units for M: lbf-ft

Z axis	DEAD	LIVE ROOF	TOTAL
A	790	1026	1816
B	0	0	0

Reaction Location



LOAD LIST

Type	Name	Left Magnitude	Right Magnitude	Load Start (ft)	Load End (ft)	Load Type	Direction
Self Weight (lbf/ft)	-	7.01	7.01	0	19.6	Dead	Z

LINKED LOAD LIST

Type	Left Magnitude	Right Magnitude	Load Start (ft)	Load End (ft)	Load Type	Direction
Axial (lbf)	-652.8516	-652.8516	19.6	19.6	Dead	Z
Axial (lbf)	-1026.41	-1026.41	19.6	19.6	RoofLive	Z

PASS

DATE:	3/24/2023	COMPANY:	Architects Northwest
STRUCALC BUILD:	StruCalc Plus	DESIGNED BY:	Sarah Weight
CUSTOMER:	Phan-Nguyen	REVIEWED BY:	Sarah Weight
PROJ. ADDRESS:	--	PROJECT NAME:	Phan-Nguyen
	, Mercer Island, WA		
LEVEL:	StruCalc Members	LOADING:	ASD
MEMBER NAME:	C11 - COL at GT5b	CODE:	2018 International Building Code
MEMBER TYPE:	COLUMN	NDS:	2018 NDS
MATERIAL:	Solid Sawn		
Douglas Fir-Larch	No. 2	(3) 1.5 X 5.5	DRY

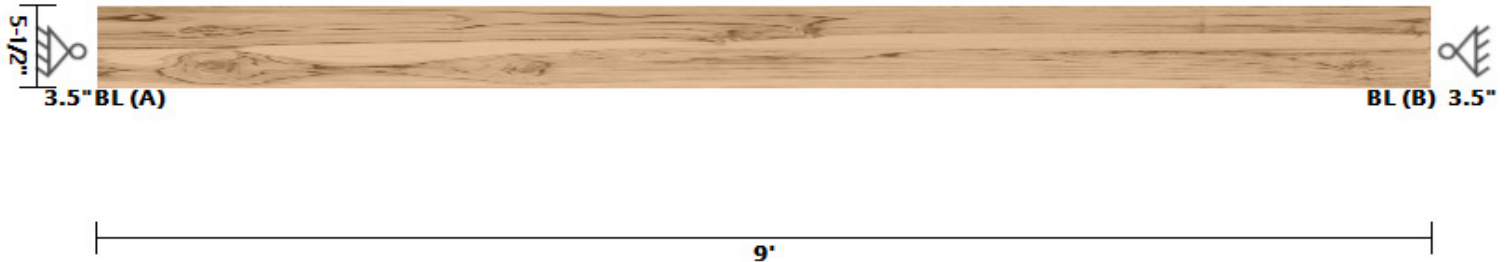
C11 - COL at GT5b DIAGRAM**COLUMN PROPERTIES**

Start(ft) 0 End(ft): 9

Area	I _x	I _y	BSW	Lams	G	K _{cr}
(in ²)	(in ⁴)	(in ⁴)	(lbf/ft)			Creep Factor
24.75	62.39	41.77	5.64	3	0.5	1

STRENGTH PROPERTIES

	F _b (psi)	F _t (psi)	F _v (psi)	F _c (psi)	F _{c⊥} (psi)	E (psi) x10 ³	E _{min} (psi) x10 ³
Base Values	900	575	180	1350	625	1600	580
Adjusted Values	1170	748	180	1485	625	1600	580
C _M	1	1	1	1	1	1	1
C _T	1	1	1	1	1	1	1
C _i	1	1	1	1	1	1	1
C _F	1.3	1.3	1	1.1	1	1	1

Bending Adjustment Factors C_{fu} = 1 C_r = 1**COLUMN DATA**

Span	Length (ft)	Unbraced Length (ft)		Column End					
		X	Y	Offset	CP	Ke(X Axis)	Ke(Y Axis)	KeL/d (X Axis)	KeL/d (Y Axis)
1	9	9	9	0	0.30	1.00	1.00	19.64	24

PASS-FAIL

	PASS/FAIL	MAGNITUDE	STRENGTH	LOCATION (ft)	LOAD COMBO	DURATION FACTOR CD
Deflection (in)	PASS (99.7%)	0.002 (=L/56842)	0.600 (=L/180)	9	Lr	
Compressive Stress (psi)	PASS (91.1%)	49.0	549.2	0	D+Lr	1.25

REACTIONS

Units for V: lbf Units for M: lbf-ft

Z axis	DEAD	LIVE ROOF	TOTAL
A	511	702	1213
B	0	0	0

Reaction Location

**LOAD LIST**

Type	Name	Left Magnitude	Right Magnitude	Load Start (ft)	Load End (ft)	Load Type	Direction
Self Weight (lbf/ft)	-	5.64	5.64	0	9	Dead	Z

LINKED LOAD LIST

Type	Left Magnitude	Right Magnitude	Load Start (ft)	Load End (ft)	Load Type	Direction
Axial (lbf)	-459.7166	-459.7166	9	9	Dead	Z
Axial (lbf)	-702.1987	-702.1987	9	9	RoofLive	Z

DATE:	3/24/2023	COMPANY:	Architects Northwest
STRUCALC BUILD:	StruCalc Plus	DESIGNED BY:	Sarah Weight
CUSTOMER:	Phan-Nguyen	REVIEWED BY:	Sarah Weight
PROJ. ADDRESS:	--	PROJECT NAME:	Phan-Nguyen
	, Mercer Island, WA		
LEVEL:	StruCalc Members	LOADING:	ASD
MEMBER NAME:	C12 - COL at GT7b	CODE:	2018 International Building Code
MEMBER TYPE:	COLUMN	NDS:	2018 NDS
MATERIAL:	Solid Sawn		
Douglas Fir-Larch	No. 2	(3) 1.5 X 5.5	DRY

C12 - COL at GT7b DIAGRAM

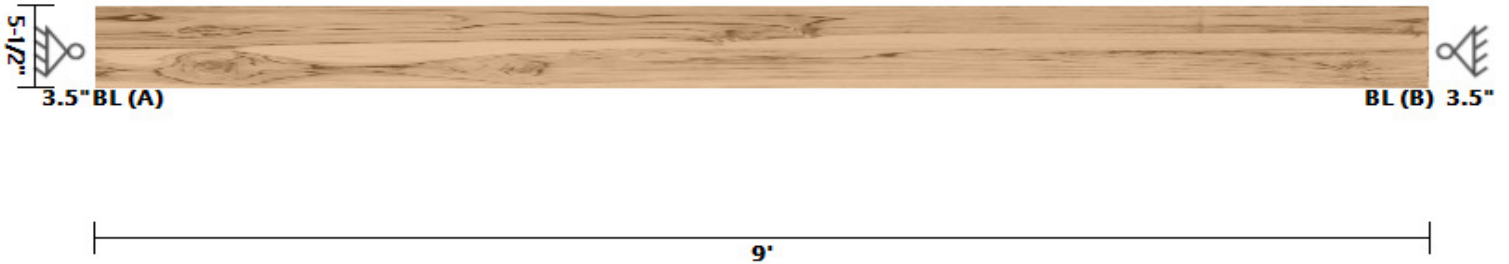

COLUMN PROPERTIES

Start(ft) 0 End(ft): 9

Area	Ix	Iy	BSW	Lams	G	Kcr
(in ²)	(in ⁴)	(in ⁴)	(lbf/ft)			Creep Factor
24.75	62.39	41.77	5.64	3	0.5	1

STRENGTH PROPERTIES

	Fb (psi)	Ft (psi)	Fv (psi)	Fc (psi)	Fc⊥ (psi)	E (psi) x10 ³	Emin (psi) x10 ³
Base Values	900	575	180	1350	625	1600	580
Adjusted Values	1170	748	180	1485	625	1600	580
C _M	1	1	1	1	1	1	1
C _T	1	1	1	1	1	1	1
C _i	1	1	1	1	1	1	1
C _F	1.3	1.3	1	1.1	1	1	1

Bending Adjustment Factors C_{fu} = 1 C_r = 1

COLUMN DATA

Span	Length (ft)	Unbraced Length (ft)		Column End					
		X	Y	Offset	CP	Ke(X Axis)	Ke(Y Axis)	KeL/d (X Axis)	KeL/d (Y Axis)
1	9	9	9	0	0.30	1.00	1.00	19.64	24

PASS-FAIL

	PASS/FAIL	MAGNITUDE	STRENGTH	LOCATION (ft)	LOAD COMBO	DURATION FACTOR CD
Deflection (in)	PASS (99.8%)	0.001 (=L/77143)	0.600 (=L/180)	9	Lr	
Compressive Stress (psi)	PASS (93.3%)	36.9	549.2	0	D+Lr	1.25

REACTIONS

Units for V: lbf Units for M: lbf-ft

Z axis	DEAD	LIVE ROOF	TOTAL
A	391	523	914
B	0	0	0

Reaction Location



LOAD LIST

Type	Name	Left Magnitude	Right Magnitude	Load Start (ft)	Load End (ft)	Load Type	Direction
Self Weight (lbf/ft)	-	5.64	5.64	0	9	Dead	Z

LINKED LOAD LIST

Type	Left Magnitude	Right Magnitude	Load Start (ft)	Load End (ft)	Load Type	Direction
Axial (lbf)	-340.3019	-340.3019	9	9	Dead	Z
Axial (lbf)	-523.0286	-523.0286	9	9	RoofLive	Z

DATE:	3/24/2023	COMPANY:	Architects Northwest
STRUCALC BUILD:	StruCalc Plus	DESIGNED BY:	Sarah Weight
CUSTOMER:	Phan-Nguyen	REVIEWED BY:	Sarah Weight
PROJ. ADDRESS:	--	PROJECT NAME:	Phan-Nguyen
	, Mercer Island, WA		
LEVEL:	StruCalc Members	LOADING:	ASD
MEMBER NAME:	C13 - COL at R01a & U01a	CODE:	2018 International Building Code
MEMBER TYPE:	COLUMN	NDS:	2018 NDS
MATERIAL:	Solid Sawn		
Douglas Fir-Larch	No. 2	(3) 1.5 X 5.5	DRY

C13 - COL at R01a & U01a DIAGRAM



COLUMN PROPERTIES

Start(ft) 0 End(ft): 10

Area	Ix	Iy	BSW	Lams	G	Kcr
(in ²)	(in ⁴)	(in ⁴)	(lbf/ft)			Creep Factor
24.75	62.39	41.77	5.64	3	0.5	1

STRENGTH PROPERTIES

	Fb (psi)	Ft (psi)	Fv (psi)	Fc (psi)	Fc⊥ (psi)	E (psi) x10 ³	Emin (psi) x10 ³
Base Values	900	575	180	1350	625	1600	580
Adjusted Values	1170	748	180	1485	625	1600	580
C _M	1	1	1	1	1	1	1
C _T	1	1	1	1	1	1	1
C _i	1	1	1	1	1	1	1
C _F	1.3	1.3	1	1.1	1	1	1

Bending Adjustment Factors C_{fu} = 1 C_r = 1

COLUMN DATA

Span	Length (ft)	Unbraced Length (ft)		Column End					
		X	Y	Offset	CP	Ke(X Axis)	Ke(Y Axis)	KeL/d (X Axis)	KeL/d (Y Axis)
1	10	10	10	0	0.30	1.00	1.00	21.82	26.67

PASS-FAIL

	PASS/FAIL	MAGNITUDE	STRENGTH	LOCATION (ft)	LOAD COMBO	DURATION FACTOR CD
Deflection (in)	PASS (99.2%)	0.005 (=L/22643)	0.667 (=L/180)	10	L	
Compressive Stress (psi)	PASS (73.0%)	120.0	444.0	0	D+L	1

REACTIONS

Units for V: lbf Units for M: lbf-ft

Z axis	DEAD	LIVE	TOTAL
A	1230	1740	2970
B	0	0	0

Reaction Location



LOAD LIST

Type	Name	Left Magnitude	Right Magnitude	Load Start (ft)	Load End (ft)	Load Type	Direction
Self Weight (lbf/ft)	-	5.64	5.64	0	10	Dead	Z

LINKED LOAD LIST

Type	Left Magnitude	Right Magnitude	Load Start (ft)	Load End (ft)	Load Type	Direction
Axial (lbf)	-67.20981	-67.20981	10	10	Dead	Z
Axial (lbf)	-1106.751	-1106.751	10	10	Dead	Z
Axial (lbf)	-1740	-1740	10	10	Live	Z

PASS

DATE:	3/24/2023	COMPANY:	Architects Northwest
STRUCALC BUILD:	StruCalc Plus	DESIGNED BY:	Sarah Weight
CUSTOMER:	Phan-Nguyen	REVIEWED BY:	Sarah Weight
PROJ. ADDRESS:	--	PROJECT NAME:	Phan-Nguyen
	, Mercer Island, WA		
LEVEL:	StruCalc Members	LOADING:	ASD
MEMBER NAME:	C14 - COL at R01b & U01b	CODE:	2018 International Building Code
MEMBER TYPE:	COLUMN	NDS:	2018 NDS
MATERIAL:	Solid Sawn		
Douglas Fir-Larch	No. 2	(3) 1.5 X 5.5	DRY

C14 - COL at R01b & U01b DIAGRAM**COLUMN PROPERTIES**

Start(ft) 0 End(ft): 10

Area	I _x	I _y	BSW	Lams	G	K _{cr}
(in ²)	(in ⁴)	(in ⁴)	(lbf/ft)			Creep Factor
24.75	62.39	41.77	5.64	3	0.5	1

STRENGTH PROPERTIES

	F _b (psi)	F _t (psi)	F _v (psi)	F _c (psi)	F _{c⊥} (psi)	E (psi) x10 ³	E _{min} (psi) x10 ³
Base Values	900	575	180	1350	625	1600	580
Adjusted Values	1170	748	180	1485	625	1600	580
C _M	1	1	1	1	1	1	1
C _T	1	1	1	1	1	1	1
C _i	1	1	1	1	1	1	1
C _F	1.3	1.3	1	1.1	1	1	1

Bending Adjustment Factors C_{fu} = 1 C_r = 1**COLUMN DATA**

Span	Length (ft)	Unbraced Length (ft)		Column End					
		X	Y	Offset	CP	Ke(X Axis)	Ke(Y Axis)	KeL/d (X Axis)	KeL/d (Y Axis)
1	10	10	10	0	0.30	1.00	1.00	21.82	26.67

PASS-FAIL

	PASS/FAIL	MAGNITUDE	STRENGTH	LOCATION (ft)	LOAD COMBO	DURATION FACTOR CD
Deflection (in)	PASS (99.2%)	0.005 (=L/22643)	0.667 (=L/180)	10	L	
Compressive Stress (psi)	PASS (72.9%)	120.2	444.0	0	D+L	1

REACTIONS

Units for V: lbf Units for M: lbf-ft

Z axis	DEAD	LIVE	TOTAL
A	1236	1740	2976
B	0	0	0

Reaction Location

**LOAD LIST**

Type	Name	Left Magnitude	Right Magnitude	Load Start (ft)	Load End (ft)	Load Type	Direction
Self Weight (lbf/ft)	-	5.64	5.64	0	10	Dead	Z

LINKED LOAD LIST

Type	Left Magnitude	Right Magnitude	Load Start (ft)	Load End (ft)	Load Type	Direction
Axial (lbf)	-72.65992	-72.65992	10	10	Dead	Z
Axial (lbf)	-1106.751	-1106.751	10	10	Dead	Z
Axial (lbf)	-1740	-1740	10	10	Live	Z

DATE:	3/24/2023	COMPANY:	Architects Northwest
STRUCALC BUILD:	StruCalc Plus	DESIGNED BY:	Sarah Weight
CUSTOMER:	Phan-Nguyen	REVIEWED BY:	Sarah Weight
PROJ. ADDRESS:	--	PROJECT NAME:	Phan-Nguyen
	, Mercer Island, WA		
LEVEL:	StruCalc Members	LOADING:	ASD
MEMBER NAME:	C15 - COL at U02ab	CODE:	2018 International Building Code
MEMBER TYPE:	COLUMN	NDS:	2018 NDS
MATERIAL:	Solid Sawn		
Douglas Fir-Larch	No. 2	(3) 1.5 X 5.5	DRY

C15 - COL at U02ab DIAGRAM

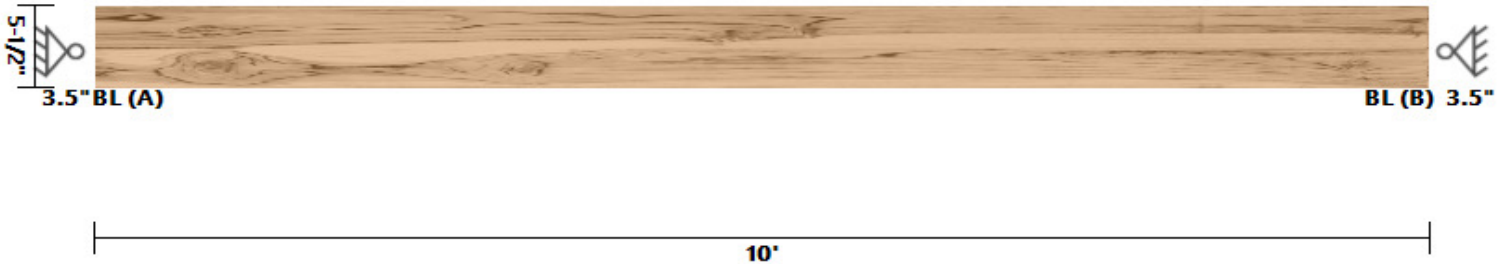

COLUMN PROPERTIES

Start(ft) 0 End(ft): 10

Area	I _x	I _y	BSW	Lams	G	K _{cr}
(in ²)	(in ⁴)	(in ⁴)	(lbf/ft)			Creep Factor
24.75	62.39	41.77	5.64	3	0.5	1

STRENGTH PROPERTIES

	F _b (psi)	F _t (psi)	F _v (psi)	F _c (psi)	F _{c⊥} (psi)	E (psi) x10 ³	E _{min} (psi) x10 ³
Base Values	900	575	180	1350	625	1600	580
Adjusted Values	1170	748	180	1485	625	1600	580
C _M	1	1	1	1	1	1	1
C _T	1	1	1	1	1	1	1
C _i	1	1	1	1	1	1	1
C _F	1.3	1.3	1	1.1	1	1	1

Bending Adjustment Factors C_{fu} = 1 C_r = 1

COLUMN DATA

Span	Length (ft)	Unbraced Length (ft)		Column End					
		X	Y	Offset	CP	Ke(X Axis)	Ke(Y Axis)	KeL/d (X Axis)	KeL/d (Y Axis)
1	10	10	10	0	0.30	1.00	1.00	21.82	26.67

PASS-FAIL

	PASS/FAIL	MAGNITUDE	STRENGTH	LOCATION (ft)	LOAD COMBO	DURATION FACTOR CD
Deflection (in)	PASS (98.6%)	0.009 (=L/13187)	0.667 (=L/180)	10	L	
Compressive Stress (psi)	PASS (55.9%)	195.7	444.0	0	D+L	1

REACTIONS

Units for V: lbf Units for M: lbf-ft

Z axis	DEAD	LIVE	TOTAL
A	1854	2990	4844
B	0	0	0

Reaction Location



LOAD LIST

Type	Name	Left Magnitude	Right Magnitude	Load Start (ft)	Load End (ft)	Load Type	Direction
Self Weight (lbf/ft)	-	5.64	5.64	0	10	Dead	Z

LINKED LOAD LIST

Type	Left Magnitude	Right Magnitude	Load Start (ft)	Load End (ft)	Load Type	Direction
Axial (lbf)	-1797.421	-1797.421	10	10	Dead	Z
Axial (lbf)	-2990	-2990	10	10	Live	Z

PASS

DATE:	3/24/2023	COMPANY:	Architects Northwest
STRUCALC BUILD:	StruCalc Plus	DESIGNED BY:	Sarah Weight
CUSTOMER:	Phan-Nguyen	REVIEWED BY:	Sarah Weight
PROJ. ADDRESS:	--	PROJECT NAME:	Phan-Nguyen
	, Mercer Island, WA		
LEVEL:	StruCalc Members	LOADING:	ASD
MEMBER NAME:	C16 - COL at U03ab	CODE:	2018 International Building Code
MEMBER TYPE:	COLUMN	NDS:	2018 NDS
MATERIAL:	Solid Sawn		
Douglas Fir-Larch	No. 2	(1) 3.5 X 3.5	DRY

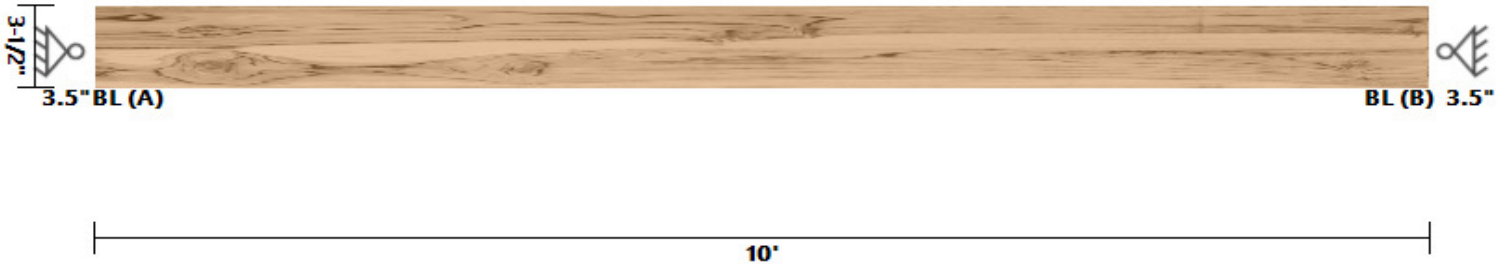
C16 - COL at U03ab DIAGRAM**COLUMN PROPERTIES**

Start(ft) 0 End(ft): 10

Area	I _x	I _y	BSW	Lams	G	K _{cr}
(in ²)	(in ⁴)	(in ⁴)	(lbf/ft)			Creep Factor
12.25	12.51	12.51	2.79	1	0.5	1

STRENGTH PROPERTIES

	F _b (psi)	F _t (psi)	F _v (psi)	F _c (psi)	F _{c⊥} (psi)	E (psi) x10 ³	E _{min} (psi) x10 ³
Base Values	900	575	180	1350	625	1600	580
Adjusted Values	1350	862	180	1552	625	1600	580
C _M	1	1	1	1	1	1	1
C _T	1	1	1	1	1	1	1
C _i	1	1	1	1	1	1	1
C _F	1.5	1.5	1	1.15	1	1	1

Bending Adjustment Factors C_{fu} = 1 C_r = 1**COLUMN DATA**

Span	Length (ft)	Unbraced Length (ft)		Column End					
		X	Y	Offset	CP	Ke(X Axis)	Ke(Y Axis)	KeL/d (X Axis)	KeL/d (Y Axis)
1	10	10	10	0	0.25	1.00	1.00	34.29	34.29

PASS-FAIL

	PASS/FAIL	MAGNITUDE	STRENGTH	LOCATION (ft)	LOAD COMBO	DURATION FACTOR CD
Deflection (in)	PASS (99.1%)	0.006 (=L/20340)	0.667 (=L/180)	10	L	
Compressive Stress (psi)	PASS (51.8%)	183.6	380.8	0	D+L	1

REACTIONS

Units for V: lbf Units for M: lbf-ft

Z axis	DEAD	LIVE	TOTAL
A	1293	956	2249
B	0	0	0

Reaction Location

**LOAD LIST**

Type	Name	Left Magnitude	Right Magnitude	Load Start (ft)	Load End (ft)	Load Type	Direction
Self Weight (lbf/ft)	-	2.79	2.79	0	10	Dead	Z

LINKED LOAD LIST

Type	Left Magnitude	Right Magnitude	Load Start (ft)	Load End (ft)	Load Type	Direction
Axial (lbf)	-1264.656	-1264.656	10	10	Dead	Z
Axial (lbf)	-955.9999	-955.9999	10	10	Live	Z

DATE:	3/24/2023	COMPANY:	Architects Northwest
STRUCALC BUILD:	StruCalc Plus	DESIGNED BY:	Sarah Weight
CUSTOMER:	Phan-Nguyen	REVIEWED BY:	Sarah Weight
PROJ. ADDRESS:	-- Mercer Island, WA	PROJECT NAME:	Phan-Nguyen
LEVEL:	StruCalc Members	LOADING:	ASD
MEMBER NAME:	C17 - COL at U04a	CODE:	2018 International Building Code
MEMBER TYPE:	COLUMN	NDS:	2018 NDS
MATERIAL:	Solid Sawn		
Douglas Fir-Larch	No. 2	(1) 3.5 X 3.5	DRY

C17 - COL at U04a DIAGRAM



COLUMN PROPERTIES

Start(ft) 0 End(ft): 10

Area	Ix	Iy	BSW	Lams	G	Kcr
(in ²)	(in ⁴)	(in ⁴)	(lbf/ft)			Creep Factor
12.25	12.51	12.51	2.79	1	0.5	1

STRENGTH PROPERTIES

	Fb (psi)	Ft (psi)	Fv (psi)	Fc (psi)	Fc⊥ (psi)	E (psi) x10 ³	Emin (psi) x10 ³
Base Values	900	575	180	1350	625	1600	580
Adjusted Values	1350	862	180	1552	625	1600	580
C _M	1	1	1	1	1	1	1
C _T	1	1	1	1	1	1	1
C _i	1	1	1	1	1	1	1
C _F	1.5	1.5	1	1.15	1	1	1

Bending Adjustment Factors C_{fu} = 1 C_r = 1

COLUMN DATA

Span	Length (ft)	Unbraced Length (ft)		Column End					
		X	Y	Offset	CP	Ke(X Axis)	Ke(Y Axis)	KeL/d (X Axis)	KeL/d (Y Axis)
1	10	10	10	0	0.27	1.00	1.00	34.29	34.29

PASS-FAIL

	PASS/FAIL	MAGNITUDE	STRENGTH	LOCATION (ft)	LOAD COMBO	DURATION FACTOR CD
Compressive Stress (psi)	PASS (96.8%)	12.2	377.6	0	D	0.9

REACTIONS

Units for V: lbf Units for M: lbf-ft

Z axis	DEAD	TOTAL
A	149	149
B	0	0

Reaction Location



LOAD LIST

Type	Name	Left Magnitude	Right Magnitude	Load Start (ft)	Load End (ft)	Load Type	Direction
Self Weight (lbf/ft)	-	2.79	2.79	0	10	Dead	Z

LINKED LOAD LIST

Type	Left Magnitude	Right Magnitude	Load Start (ft)	Load End (ft)	Load Type	Direction
Axial (lbf)	-121.1266	-121.1266	10	10	Dead	Z

PASS

DATE:	3/24/2023	COMPANY:	Architects Northwest
STRUCALC BUILD:	StruCalc Plus	DESIGNED BY:	Sarah Weight
CUSTOMER:	Phan-Nguyen	REVIEWED BY:	Sarah Weight
PROJ. ADDRESS:	-- Mercer Island, WA	PROJECT NAME:	Phan-Nguyen
LEVEL:	StruCalc Members	LOADING:	ASD
MEMBER NAME:	C18 - COL at U04b	CODE:	2018 International Building Code
MEMBER TYPE:	COLUMN	NDS:	2018 NDS
MATERIAL:	Solid Sawn		
Douglas Fir-Larch	No. 2	(1) 3.5 X 3.5	DRY

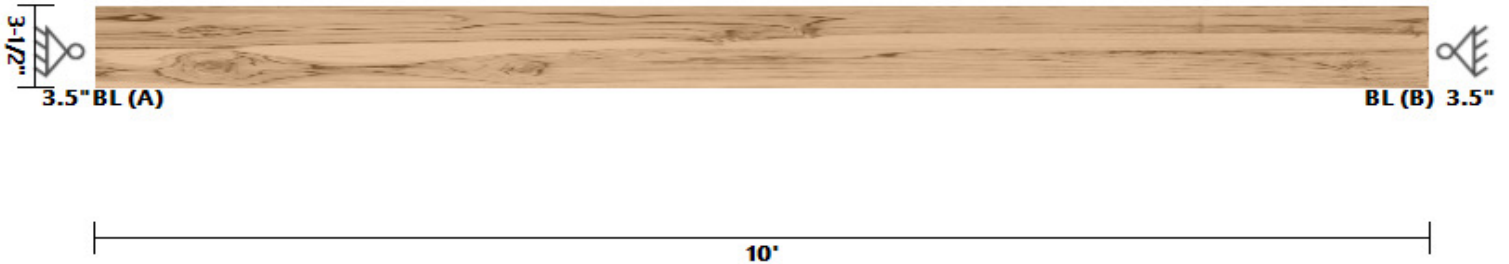
C18 - COL at U04b DIAGRAM**COLUMN PROPERTIES**

Start(ft) 0 End(ft): 10

Area	I _x	I _y	BSW	Lams	G	K _{cr}
(in ²)	(in ⁴)	(in ⁴)	(lb/ft)			Creep Factor
12.25	12.51	12.51	2.79	1	0.5	1

STRENGTH PROPERTIES

	F _b (psi)	F _t (psi)	F _v (psi)	F _c (psi)	F _{c⊥} (psi)	E (psi) x10 ³	E _{min} (psi) x10 ³
Base Values	900	575	180	1350	625	1600	580
Adjusted Values	1350	862	180	1552	625	1600	580
C _M	1	1	1	1	1	1	1
C _T	1	1	1	1	1	1	1
C _i	1	1	1	1	1	1	1
C _F	1.5	1.5	1	1.15	1	1	1

Bending Adjustment Factors C_{fu} = 1 C_r = 1**COLUMN DATA**

Span	Length (ft)	Unbraced Length (ft)		Column End					
		X	Y	Offset	CP	Ke(X Axis)	Ke(Y Axis)	KeL/d (X Axis)	KeL/d (Y Axis)
1	10	10	10	0	0.27	1.00	1.00	34.29	34.29

PASS-FAIL

	PASS/FAIL	MAGNITUDE	STRENGTH	LOCATION (ft)	LOAD COMBO	DURATION FACTOR CD
Compressive Stress (psi)	PASS (96.8%)	12.2	377.6	0	D	0.9

REACTIONS

Units for V: lbf Units for M: lbf-ft

Z axis	DEAD	TOTAL
A	149	149
B	0	0

Reaction Location

A

B

LOAD LIST

Type	Name	Left Magnitude	Right Magnitude	Load Start (ft)	Load End (ft)	Load Type	Direction
Self Weight (lb/ft)	-	2.79	2.79	0	10	Dead	Z

LINKED LOAD LIST

Type	Left Magnitude	Right Magnitude	Load Start (ft)	Load End (ft)	Load Type	Direction
Axial (lbf)	-121.1266	-121.1266	10	10	Dead	Z

DATE:	3/24/2023	COMPANY:	Architects Northwest
STRUCALC BUILD:	StruCalc Plus	DESIGNED BY:	Sarah Weight
CUSTOMER:	Phan-Nguyen	REVIEWED BY:	Sarah Weight
PROJ. ADDRESS:	--	PROJECT NAME:	Phan-Nguyen
	, Mercer Island, WA		
LEVEL:	StruCalc Members	LOADING:	ASD
MEMBER NAME:	C19 - COL at U06a	CODE:	2018 International Building Code
MEMBER TYPE:	COLUMN	NDS:	2018 NDS
MATERIAL:	Solid Sawn		
Douglas Fir-Larch	No. 2	(3) 1.5 X 5.5	DRY

C19 - COL at U06a DIAGRAM

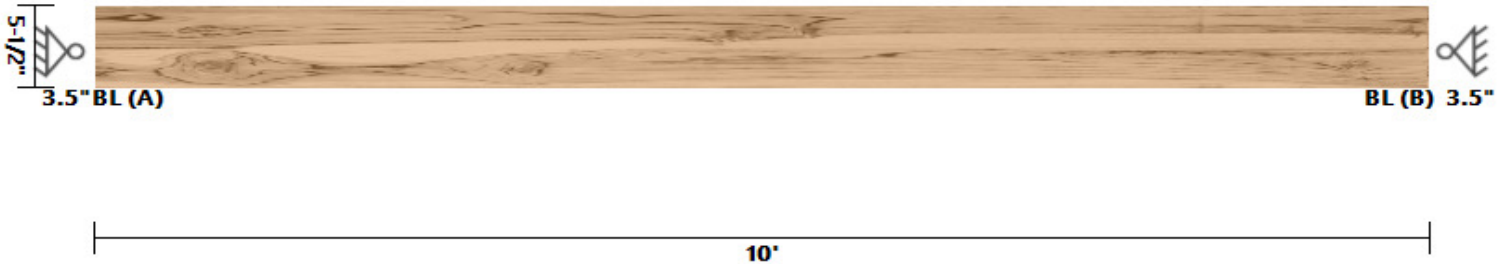

COLUMN PROPERTIES

Start(ft) 0 End(ft): 10

Area	Ix	Iy	BSW	Lams	G	Kcr
(in ²)	(in ⁴)	(in ⁴)	(lbf/ft)			Creep Factor
24.75	62.39	41.77	5.64	3	0.5	1

STRENGTH PROPERTIES

	Fb (psi)	Ft (psi)	Fv (psi)	Fc (psi)	Fc⊥ (psi)	E (psi) x10 ³	Emin (psi) x10 ³
Base Values	900	575	180	1350	625	1600	580
Adjusted Values	1170	748	180	1485	625	1600	580
C _M	1	1	1	1	1	1	1
C _T	1	1	1	1	1	1	1
C _i	1	1	1	1	1	1	1
C _F	1.3	1.3	1	1.1	1	1	1

Bending Adjustment Factors C_{fu} = 1 C_r = 1

COLUMN DATA

Span	Length (ft)	Unbraced Length (ft)		Column End					
		X	Y	Offset	CP	Ke(X Axis)	Ke(Y Axis)	KeL/d (X Axis)	KeL/d (Y Axis)
1	10	10	10	0	0.30	1.00	1.00	21.82	26.67

PASS-FAIL

	PASS/FAIL	MAGNITUDE	STRENGTH	LOCATION (ft)	LOAD COMBO	DURATION FACTOR CD
Deflection (in)	PASS (98.6%)	0.009 (=L/13044)	0.667 (=L/180)	10	L	
Compressive Stress (psi)	PASS (54.9%)	200.4	444.0	0	D+L	1

REACTIONS

Units for V: lbf Units for M: lbf-ft

Z axis	DEAD	LIVE	LIVE ROOF	TOTAL
A	1929	3032	76	5037
B	0	0	0	0

Reaction Location



LOAD LIST

Type	Name	Left Magnitude	Right Magnitude	Load Start (ft)	Load End (ft)	Load Type	Direction
Self Weight (lbf/ft)	-	5.64	5.64	0	10	Dead	Z

LINKED LOAD LIST

Type	Left Magnitude	Right Magnitude	Load Start (ft)	Load End (ft)	Load Type	Direction
Axial (lbf)	-1872.2	-1872.2	10	10	Dead	Z
Axial (lbf)	-3032.151	-3032.151	10	10	Live	Z
Axial (lbf)	-75.61728	-75.61728	10	10	RoofLive	Z

PASS

DATE:	3/24/2023	COMPANY:	Architects Northwest
STRUCALC BUILD:	StruCalc Plus	DESIGNED BY:	Sarah Weight
CUSTOMER:	Phan-Nguyen	REVIEWED BY:	Sarah Weight
PROJ. ADDRESS:	--	PROJECT NAME:	Phan-Nguyen
	, Mercer Island, WA		
LEVEL:	StruCalc Members	LOADING:	ASD
MEMBER NAME:	C20 - COL at U06b	CODE:	2018 International Building Code
MEMBER TYPE:	COLUMN	NDS:	2018 NDS
MATERIAL:	Solid Sawn		
Douglas Fir-Larch	No. 2	(1) 5.5 X 5.5	DRY

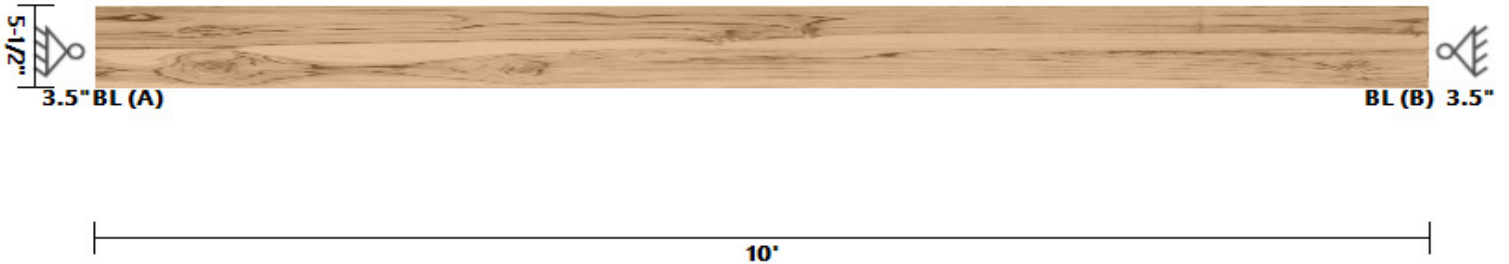
C20 - COL at U06b DIAGRAM**COLUMN PROPERTIES**

Start(ft) 0 End(ft): 10

Area	I _x	I _y	BSW	Lams	G	K _{cr}
(in ²)	(in ⁴)	(in ⁴)	(lbf/ft)			Creep Factor
30.25	76.26	76.26	6.9	1	0.5	1

STRENGTH PROPERTIES

	F _b (psi)	F _t (psi)	F _v (psi)	F _c (psi)	F _{c⊥} (psi)	E (psi) x10 ³	E _{min} (psi) x10 ³
Base Values	750	475	170	700	625	1300	470
Adjusted Values	750	475	170	700	625	1300	470
C _M	1	1	1	1	1	1	1
C _T	1	1	1	1	1	1	1
C _i	1	1	1	1	1	1	1
C _F	1	1	1	1	1	1	1

Bending Adjustment Factors C_{fu} = 1 C_r = 1**COLUMN DATA**

Span	Length (ft)	Unbraced Length (ft)		Column End					
		X	Y	Offset	CP	Ke(X Axis)	Ke(Y Axis)	KeL/d (X Axis)	KeL/d (Y Axis)
1	10	10	10	0	0.74	1.00	1.00	21.82	21.82

PASS-FAIL

	PASS/FAIL	MAGNITUDE	STRENGTH	LOCATION (ft)	LOAD COMBO	DURATION FACTOR CD
Deflection (in)	PASS (98.8%)	0.008 (=L/15001)	0.667 (=L/180)	10	L	
Compressive Stress (psi)	PASS (72.8%)	141.0	517.7	0	D+L	1

REACTIONS

Units for V: lbf Units for M: lbf-ft

Z axis	DEAD	LIVE	LIVE ROOF	TOTAL
A	1651	2613	118	4382
B	0	0	0	0

Reaction Location

A

B

LOAD LIST

Type	Name	Left Magnitude	Right Magnitude	Load Start (ft)	Load End (ft)	Load Type	Direction
Self Weight (lbf/ft)	-	6.9	6.9	0	10	Dead	Z

LINKED LOAD LIST

Type	Left Magnitude	Right Magnitude	Load Start (ft)	Load End (ft)	Load Type	Direction
Axial (lbf)	-1582.491	-1582.491	10	10	Dead	Z
Axial (lbf)	-118.2742	-118.2742	10	10	RoofLive	Z
Axial (lbf)	-2613.239	-2613.239	10	10	Live	Z

PASS

DATE:	3/24/2023	COMPANY:	Architects Northwest
STRUCALC BUILD:	StruCalc Plus	DESIGNED BY:	Sarah Weight
CUSTOMER:	Phan-Nguyen	REVIEWED BY:	Sarah Weight
PROJ. ADDRESS:	--	PROJECT NAME:	Phan-Nguyen
	, Mercer Island, WA		
LEVEL:	StruCalc Members	LOADING:	ASD
MEMBER NAME:	C21 - COL at U10a	CODE:	2018 International Building Code
MEMBER TYPE:	COLUMN	NDS:	2018 NDS
MATERIAL:	Solid Sawn		
Douglas Fir-Larch	No. 2	(3) 1.5 X 5.5	DRY

C21 - COL at U10a DIAGRAM**COLUMN PROPERTIES**

Start(ft) 0 End(ft): 10

Area	I _x	I _y	BSW	Lams	G	K _{cr}
(in ²)	(in ⁴)	(in ⁴)	(lbf/ft)			Creep Factor
24.75	62.39	41.77	5.64	3	0.5	1

STRENGTH PROPERTIES

	F _b (psi)	F _t (psi)	F _v (psi)	F _c (psi)	F _{c⊥} (psi)	E (psi) x10 ³	E _{min} (psi) x10 ³
Base Values	900	575	180	1350	625	1600	580
Adjusted Values	1170	748	180	1485	625	1600	580
C _M	1	1	1	1	1	1	1
C _T	1	1	1	1	1	1	1
C _i	1	1	1	1	1	1	1
C _F	1.3	1.3	1	1.1	1	1	1

Bending Adjustment Factors C_{fu} = 1 C_r = 1**COLUMN DATA**

Span	Length (ft)	Unbraced Length (ft)		Column End					
		X	Y	Offset	CP	Ke(X Axis)	Ke(Y Axis)	KeL/d (X Axis)	KeL/d (Y Axis)
1	10	10	10	0	0.30	1.00	1.00	21.82	26.67

PASS-FAIL

	PASS/FAIL	MAGNITUDE	STRENGTH	LOCATION (ft)	LOAD COMBO	DURATION FACTOR CD
Deflection (in)	PASS (99.2%)	0.005 (=L/23078)	0.667 (=L/180)	10	L	
Compressive Stress (psi)	PASS (74.3%)	114.3	444.0	0	D+L	1

REACTIONS

Units for V: lbf Units for M: lbf-ft

Z axis	DEAD	LIVE	TOTAL
A	1121	1707	2828
B	0	0	0

Reaction Location

**LOAD LIST**

Type	Name	Left Magnitude	Right Magnitude	Load Start (ft)	Load End (ft)	Load Type	Direction
Self Weight (lbf/ft)	-	5.64	5.64	0	10	Dead	Z

LINKED LOAD LIST

Type	Left Magnitude	Right Magnitude	Load Start (ft)	Load End (ft)	Load Type	Direction
Axial (lbf)	-1064.265	-1064.265	10	10	Dead	Z
Axial (lbf)	-1707.043	-1707.043	10	10	Live	Z

PASS

DATE:	3/24/2023	COMPANY:	Architects Northwest
STRUCALC BUILD:	StruCalc Plus	DESIGNED BY:	Sarah Weight
CUSTOMER:	Phan-Nguyen	REVIEWED BY:	Sarah Weight
PROJ. ADDRESS:	-- Mercer Island, WA	PROJECT NAME:	Phan-Nguyen
LEVEL:	StruCalc Members	LOADING:	ASD
MEMBER NAME:	C22 - COL at R03b, HDR, U10b & U0...	CODE:	2018 International Building Code
MEMBER TYPE:	COLUMN	NDS:	2018 NDS
MATERIAL:	Solid Sawn		
Douglas Fir-Larch	No. 2	(1) 5.5 X 5.5	DRY

C22 - COL at R03b, HDR, U10b & U09b DIAGRAM**COLUMN PROPERTIES**

Start(ft) 0 End(ft): 10

Area	I _x	I _y	BSW	Lams	G	K _{cr}
(in ²)	(in ⁴)	(in ⁴)	(lbf/ft)			Creep Factor
30.25	76.26	76.26	6.9	1	0.5	1

STRENGTH PROPERTIES

	F _b (psi)	F _t (psi)	F _v (psi)	F _c (psi)	F _c ⊥ (psi)	E (psi) x10 ³	E _{min} (psi) x10 ³
Base Values	750	475	170	700	625	1300	470
Adjusted Values	750	475	170	700	625	1300	470
C _M	1	1	1	1	1	1	1
C _T	1	1	1	1	1	1	1
C _i	1	1	1	1	1	1	1
C _F	1	1	1	1	1	1	1

Bending Adjustment Factors C_{fu} = 1 C_r = 1**COLUMN DATA**

Span	Length (ft)	Unbraced Length (ft)		Column End					
		X	Y	Offset	CP	Ke(X Axis)	Ke(Y Axis)	KeL/d (X Axis)	KeL/d (Y Axis)
1	10	10	10	0	0.74	1.00	1.00	21.82	21.82

PASS-FAIL

	PASS/FAIL	MAGNITUDE	STRENGTH	LOCATION (ft)	LOAD COMBO	DURATION FACTOR CD
Deflection (in)	PASS (97.1%)	0.019 (=L/6250)	0.667 (=L/180)	10	D+L	
Compressive Stress (psi)	PASS (59.6%)	209.3	517.7	0	D+L	1

REACTIONS

Units for V: lbf Units for M: lbf-ft

Z axis	DEAD	LIVE	LIVE ROOF	TOTAL
A	3478	2852	1350	7680
B	0	0	0	0

Reaction Location

A

B

LOAD LIST

Type	Name	Left Magnitude	Right Magnitude	Load Start (ft)	Load End (ft)	Load Type	Direction
Axial (lbf)	HDR	-496	-496	10	10	Live	Z
Axial (lbf)	HDR	-327	-327	10	10	Dead	Z
Self Weight (lbf/ft)	-	6.9	6.9	0	10	Dead	Z

LINKED LOAD LIST

Type	Left Magnitude	Right Magnitude	Load Start (ft)	Load End (ft)	Load Type	Direction
Axial (lbf)	-126.2368	-126.2368	10	10	Dead	Z
Axial (lbf)	-2169.296	-2169.296	10	10	Dead	Z
Axial (lbf)	-1044	-1044	10	10	Live	Z
Axial (lbf)	-1350	-1350	10	10	RoofLive	Z
Axial (lbf)	-786.892	-786.892	10	10	Dead	Z
Axial (lbf)	-1311.962	-1311.962	10	10	Live	Z

PASS

DATE:	3/24/2023	COMPANY:	Architects Northwest
STRUCALC BUILD:	StruCalc Plus	DESIGNED BY:	Sarah Weight
CUSTOMER:	Phan-Nguyen	REVIEWED BY:	Sarah Weight
PROJ. ADDRESS:	-- Mercer Island, WA	PROJECT NAME:	Phan-Nguyen
LEVEL:	StruCalc Members	LOADING:	ASD
MEMBER NAME:	C23 - COL at R03a, HDR, U09a, & U1...	CODE:	2018 International Building Code
MEMBER TYPE:	COLUMN	NDS:	2018 NDS
MATERIAL:	Solid Sawn		
Douglas Fir-Larch	No. 2	(1) 5.5 X 5.5	DRY

C23 - COL at R03a, HDR, U09a, & U11b DIAGRAM

10'

COLUMN PROPERTIES

Start(ft) 0 End(ft): 10

Area	I _x	I _y	BSW	Lams	G	K _{cr}
(in ²)	(in ⁴)	(in ⁴)	(lbf/ft)			Creep Factor
30.25	76.26	76.26	6.9	1	0.5	1

STRENGTH PROPERTIES

	F _b (psi)	F _t (psi)	F _v (psi)	F _c (psi)	F _{c⊥} (psi)	E (psi) x10 ³	E _{min} (psi) x10 ³
Base Values	750	475	170	700	625	1300	470
Adjusted Values	750	475	170	700	625	1300	470
C _M	1	1	1	1	1	1	1
C _T	1	1	1	1	1	1	1
C _i	1	1	1	1	1	1	1
C _F	1	1	1	1	1	1	1

Bending Adjustment Factors C_{fu} = 1 C_r = 1**COLUMN DATA**

Span	Length (ft)	Unbraced Length (ft)		Column End					
		X	Y	Offset	CP	Ke(X Axis)	Ke(Y Axis)	KeL/d (X Axis)	KeL/d (Y Axis)
1	10	10	10	0	0.74	1.00	1.00	21.82	21.82

PASS-FAIL

	PASS/FAIL	MAGNITUDE	STRENGTH	LOCATION (ft)	LOAD COMBO	DURATION FACTOR CD
Deflection (in)	PASS (97.1%)	0.019 (=L/6250)	0.667 (=L/180)	10	D+L	
Compressive Stress (psi)	PASS (59.6%)	209.3	517.7	0	D+L	1

REACTIONS

Units for V: lbf Units for M: lbf-ft

Z axis	DEAD	LIVE	LIVE ROOF	TOTAL
A	3478	2852	1350	7680
B	0	0	0	0

Reaction Location

A

B

LOAD LIST

Type	Name	Left Magnitude	Right Magnitude	Load Start (ft)	Load End (ft)	Load Type	Direction
Axial (lbf)	HDR	-496	-496	10	10	Live	Z
Axial (lbf)	HDR	-327	-327	10	10	Dead	Z
Self Weight (lbf/ft)	-	6.9	6.9	0	10	Dead	Z

LINKED LOAD LIST

Type	Left Magnitude	Right Magnitude	Load Start (ft)	Load End (ft)	Load Type	Direction
Axial (lbf)	-126.2368	-126.2368	10	10	Dead	Z
Axial (lbf)	-2169.296	-2169.296	10	10	Dead	Z
Axial (lbf)	-1044	-1044	10	10	Live	Z
Axial (lbf)	-1350	-1350	10	10	RoofLive	Z
Axial (lbf)	-786.892	-786.892	10	10	Dead	Z
Axial (lbf)	-1311.962	-1311.962	10	10	Live	Z

PASS

DATE:	3/24/2023	COMPANY:	Architects Northwest
STRUCALC BUILD:	StruCalc Plus	DESIGNED BY:	Sarah Weight
CUSTOMER:	Phan-Nguyen	REVIEWED BY:	Sarah Weight
PROJ. ADDRESS:	--	PROJECT NAME:	Phan-Nguyen
	, Mercer Island, WA		
LEVEL:	StruCalc Members	LOADING:	ASD
MEMBER NAME:	C24 - COL at U05a	CODE:	2018 International Building Code
MEMBER TYPE:	COLUMN	NDS:	2018 NDS
MATERIAL:	Solid Sawn		
Douglas Fir-Larch	No. 2	(3) 1.5 X 5.5	DRY

C24 - COL at U05a DIAGRAM**COLUMN PROPERTIES**

Start(ft) 0 End(ft): 10

Area	I _x	I _y	BSW	Lams	G	K _{cr}
(in ²)	(in ⁴)	(in ⁴)	(lbf/ft)			Creep Factor
24.75	62.39	41.77	5.64	3	0.5	1

STRENGTH PROPERTIES

	F _b (psi)	F _t (psi)	F _v (psi)	F _c (psi)	F _{c⊥} (psi)	E (psi) x10 ³	E _{min} (psi) x10 ³
Base Values	900	575	180	1350	625	1600	580
Adjusted Values	1170	748	180	1485	625	1600	580
C _M	1	1	1	1	1	1	1
C _T	1	1	1	1	1	1	1
C _i	1	1	1	1	1	1	1
C _F	1.3	1.3	1	1.1	1	1	1

Bending Adjustment Factors C_{fu} = 1 C_r = 1**COLUMN DATA**

Span	Length (ft)	Unbraced Length (ft)		Column End					
		X	Y	Offset	CP	Ke(X Axis)	Ke(Y Axis)	KeL/d (X Axis)	KeL/d (Y Axis)
1	10	10	10	0	0.30	1.00	1.00	21.82	26.67

PASS-FAIL

	PASS/FAIL	MAGNITUDE	STRENGTH	LOCATION (ft)	LOAD COMBO	DURATION FACTOR CD
Deflection (in)	PASS (97.8%)	0.014 (=L/8334)	0.667 (=L/180)	10	L	
Compressive Stress (psi)	PASS (33.1%)	296.8	444.0	0	D+L	1

REACTIONS

Units for V: lbf Units for M: lbf-ft

Z axis	DEAD	LIVE	TOTAL
A	2595	4752	7347
B	0	0	0

Reaction Location

**LOAD LIST**

Type	Name	Left Magnitude	Right Magnitude	Load Start (ft)	Load End (ft)	Load Type	Direction
Self Weight (lbf/ft)	-	5.64	5.64	0	10	Dead	Z

LINKED LOAD LIST

Type	Left Magnitude	Right Magnitude	Load Start (ft)	Load End (ft)	Load Type	Direction
Axial (lbf)	-2538.355	-2538.355	10	10	Dead	Z
Axial (lbf)	-4752	-4752	10	10	Live	Z

DATE:	3/24/2023	COMPANY:	Architects Northwest
STRUCALC BUILD:	StruCalc Plus	DESIGNED BY:	Sarah Weight
CUSTOMER:	Phan-Nguyen	REVIEWED BY:	Sarah Weight
PROJ. ADDRESS:	--	PROJECT NAME:	Phan-Nguyen
	, Mercer Island, WA		
LEVEL:	StruCalc Members	LOADING:	ASD
MEMBER NAME:	C25 - COL at U12ab	CODE:	2018 International Building Code
MEMBER TYPE:	COLUMN	NDS:	2018 NDS
MATERIAL:	Solid Sawn		
Douglas Fir-Larch	No. 2	(3) 1.5 X 5.5	DRY

C25 - COL at U12ab DIAGRAM



COLUMN PROPERTIES

Start(ft) 0 End(ft): 10

Area	Ix	Iy	BSW	Lams	G	Kcr
(in ²)	(in ⁴)	(in ⁴)	(lbf/ft)			Creep Factor
24.75	62.39	41.77	5.64	3	0.5	1

STRENGTH PROPERTIES

	Fb (psi)	Ft (psi)	Fv (psi)	Fc (psi)	Fc⊥ (psi)	E (psi) x10 ³	Emin (psi) x10 ³
Base Values	900	575	180	1350	625	1600	580
Adjusted Values	1170	748	180	1485	625	1600	580
C _M	1	1	1	1	1	1	1
C _T	1	1	1	1	1	1	1
C _i	1	1	1	1	1	1	1
C _F	1.3	1.3	1	1.1	1	1	1

Bending Adjustment Factors C_{fu} = 1 C_r = 1

COLUMN DATA

Span	Length (ft)	Unbraced Length (ft)		Column End					
		X	Y	Offset	CP	Ke(X Axis)	Ke(Y Axis)	KeL/d (X Axis)	KeL/d (Y Axis)
1	10	10	10	0	0.30	1.00	1.00	21.82	26.67

PASS-FAIL

	PASS/FAIL	MAGNITUDE	STRENGTH	LOCATION (ft)	LOAD COMBO	DURATION FACTOR CD
Deflection (in)	PASS (99.2%)	0.005 (=L/23531)	0.667 (=L/180)	10	L	
Compressive Stress (psi)	PASS (70.6%)	130.6	444.0	0	D+L	1

REACTIONS

Units for V: lbf Units for M: lbf-ft

Z axis	DEAD	LIVE	LIVE ROOF	TOTAL
A	1559	1674	675	3908
B	0	0	0	0

Reaction Location



LOAD LIST

Type	Name	Left Magnitude	Right Magnitude	Load Start (ft)	Load End (ft)	Load Type	Direction
Self Weight (lbf/ft)	-	5.64	5.64	0	10	Dead	Z

LINKED LOAD LIST

Type	Left Magnitude	Right Magnitude	Load Start (ft)	Load End (ft)	Load Type	Direction
Axial (lbf)	-1502.664	-1502.664	10	10	Dead	Z
Axial (lbf)	-1674	-1674	10	10	Live	Z
Axial (lbf)	-675	-675	10	10	RoofLive	Z

PASS

DATE:	3/24/2023	COMPANY:	Architects Northwest
STRUCALC BUILD:	StruCalc Plus	DESIGNED BY:	Sarah Weight
CUSTOMER:	Phan-Nguyen	REVIEWED BY:	Sarah Weight
PROJ. ADDRESS:	-- Mercer Island, WA	PROJECT NAME:	Phan-Nguyen
LEVEL:	StruCalc Members	LOADING:	ASD
MEMBER NAME:	C26 - COL at U14b & GT3b	CODE:	2018 International Building Code
MEMBER TYPE:	COLUMN	NDS:	2018 NDS
MATERIAL:	Solid Sawn		
Douglas Fir-Larch	No. 2	(1) 5.5 X 5.5	DRY

C26 - COL at U14b & GT3b DIAGRAM

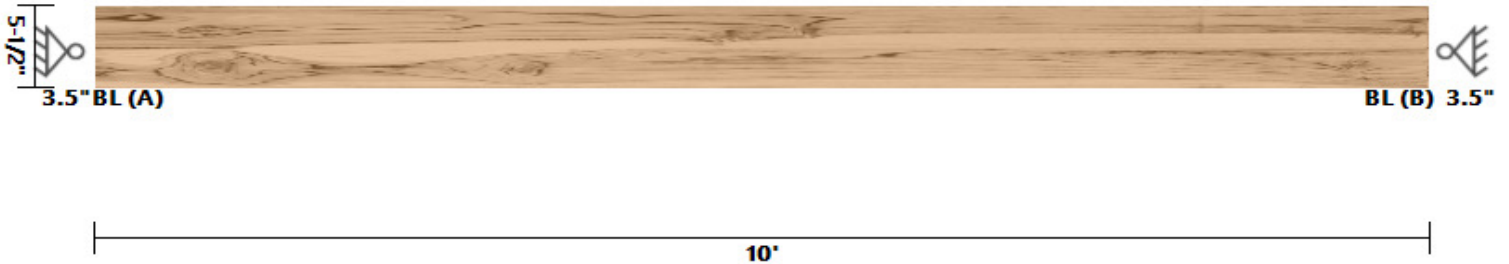

COLUMN PROPERTIES

Start(ft) 0 End(ft): 10

Area	I _x	I _y	BSW	Lams	G	K _{cr}
(in ²)	(in ⁴)	(in ⁴)	(lbf/ft)			Creep Factor
30.25	76.26	76.26	6.9	1	0.5	1

STRENGTH PROPERTIES

	F _b (psi)	F _t (psi)	F _v (psi)	F _c (psi)	F _{c⊥} (psi)	E (psi) x10 ³	E _{min} (psi) x10 ³
Base Values	750	475	170	700	625	1300	470
Adjusted Values	750	475	170	700	625	1300	470
C _M	1	1	1	1	1	1	1
C _T	1	1	1	1	1	1	1
C _i	1	1	1	1	1	1	1
C _F	1	1	1	1	1	1	1

Bending Adjustment Factors C_{fu} = 1 C_r = 1

COLUMN DATA

Span	Length (ft)	Unbraced Length (ft)		Column End					
		X	Y	Offset	CP	Ke(X Axis)	Ke(Y Axis)	KeL/d (X Axis)	KeL/d (Y Axis)
1	10	10	10	0	0.66	1.00	1.00	21.82	21.82

PASS-FAIL

	PASS/FAIL	MAGNITUDE	STRENGTH	LOCATION (ft)	LOAD COMBO	DURATION FACTOR CD
Deflection (in)	PASS (99.1%)	0.006 (=L/19049)	0.667 (=L/180)	10	Lr	
Compressive Stress (psi)	PASS (79.8%)	117.4	581.4	0	D+Lr	1.25

REACTIONS

Units for V: lbf Units for M: lbf-ft

Z axis	DEAD	LIVE ROOF	TOTAL
A	1492	2058	3550
B	0	0	0

Reaction Location



LOAD LIST

Type	Name	Left Magnitude	Right Magnitude	Load Start (ft)	Load End (ft)	Load Type	Direction
Self Weight (lbf/ft)	-	6.9	6.9	0	10	Dead	Z

LINKED LOAD LIST

Type	Left Magnitude	Right Magnitude	Load Start (ft)	Load End (ft)	Load Type	Direction
Axial (lbf)	-984.5349	-984.5349	10	10	Dead	Z
Axial (lbf)	-1625.625	-1625.625	10	10	RoofLive	Z
Axial (lbf)	-438.5865	-438.5865	10	10	Dead	Z
Axial (lbf)	-432.8525	-432.8525	10	10	RoofLive	Z

PASS

DATE:	3/24/2023	COMPANY:	Architects Northwest
STRUCALC BUILD:	StruCalc Plus	DESIGNED BY:	Sarah Weight
CUSTOMER:	Phan-Nguyen	REVIEWED BY:	Sarah Weight
PROJ. ADDRESS:	--	PROJECT NAME:	Phan-Nguyen
	, Mercer Island, WA		
LEVEL:	StruCalc Members	LOADING:	ASD
MEMBER NAME:	C27 - COL at U14a	CODE:	2018 International Building Code
MEMBER TYPE:	COLUMN	NDS:	2018 NDS
MATERIAL:	Solid Sawn		
Douglas Fir-Larch	No. 2	(3) 1.5 X 5.5	DRY

C27 - COL at U14a DIAGRAM

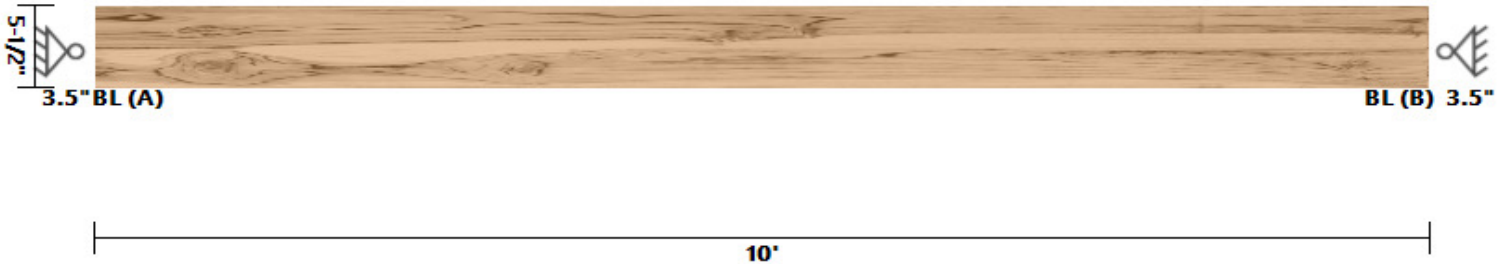

COLUMN PROPERTIES

Start(ft) 0 End(ft): 10

Area	Ix	Iy	BSW	Lams	G	Kcr
(in ²)	(in ⁴)	(in ⁴)	(lbf/ft)			Creep Factor
24.75	62.39	41.77	5.64	3	0.5	1

STRENGTH PROPERTIES

	Fb (psi)	Ft (psi)	Fv (psi)	Fc (psi)	Fc⊥ (psi)	E (psi) x10 ³	Emin (psi) x10 ³
Base Values	900	575	180	1350	625	1600	580
Adjusted Values	1170	748	180	1485	625	1600	580
C _M	1	1	1	1	1	1	1
C _T	1	1	1	1	1	1	1
C _i	1	1	1	1	1	1	1
C _F	1.3	1.3	1	1.1	1	1	1

Bending Adjustment Factors C_{fu} = 1 C_r = 1

COLUMN DATA

Span	Length (ft)	Unbraced Length (ft)		Column End					
		X	Y	Offset	CP	Ke(X Axis)	Ke(Y Axis)	KeL/d (X Axis)	KeL/d (Y Axis)
1	10	10	10	0	0.25	1.00	1.00	21.82	26.67

PASS-FAIL

	PASS/FAIL	MAGNITUDE	STRENGTH	LOCATION (ft)	LOAD COMBO	DURATION FACTOR CD
Deflection (in)	PASS (100.0%)	0.000 (=L/400020)	0.667 (=L/180)	10	Lr	
Compressive Stress (psi)	PASS (96.8%)	14.8	457.9	0	D+Lr	1.25

REACTIONS

Units for V: lbf Units for M: lbf-ft

Z axis	DEAD	LIVE ROOF	TOTAL
A	277	90	367
B	0	0	0

Reaction Location



LOAD LIST

Type	Name	Left Magnitude	Right Magnitude	Load Start (ft)	Load End (ft)	Load Type	Direction
Self Weight (lbf/ft)	-	5.64	5.64	0	10	Dead	Z

LINKED LOAD LIST

Type	Left Magnitude	Right Magnitude	Load Start (ft)	Load End (ft)	Load Type	Direction
Axial (lbf)	-220.5222	-220.5222	10	10	Dead	Z
Axial (lbf)	-90.17822	-90.17822	10	10	RoofLive	Z

PASS

DATE:	3/24/2023	COMPANY:	Architects Northwest
STRUCALC BUILD:	StruCalc Plus	DESIGNED BY:	Sarah Weight
CUSTOMER:	Phan-Nguyen	REVIEWED BY:	Sarah Weight
PROJ. ADDRESS:	--	PROJECT NAME:	Phan-Nguyen
	, Mercer Island, WA		
LEVEL:	StruCalc Members	LOADING:	ASD
MEMBER NAME:	C28 - COL at R01a, U01a, & M01a	CODE:	2018 International Building Code
MEMBER TYPE:	COLUMN	NDS:	2018 NDS
MATERIAL:	Solid Sawn		
Douglas Fir-Larch	No. 2	(3) 1.5 X 5.5	DRY

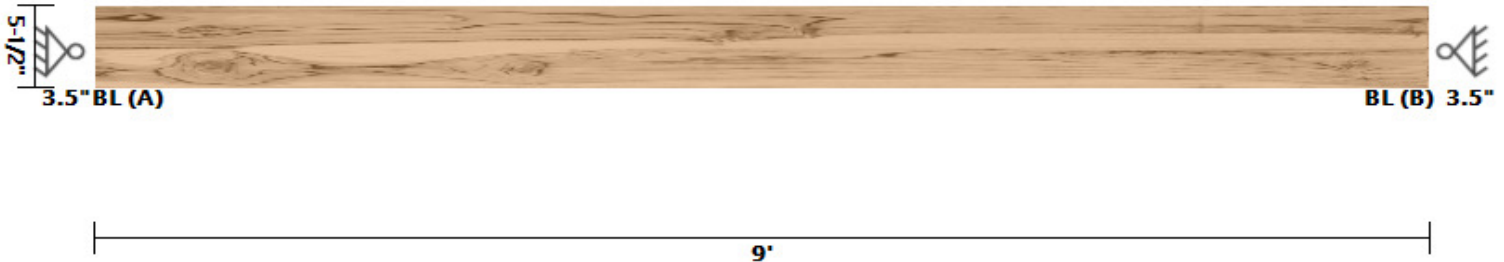
C28 - COL at R01a, U01a, & M01a DIAGRAM**COLUMN PROPERTIES**

Start(ft) 0 End(ft): 9

Area	I _x	I _y	BSW	Lams	G	K _{cr}
(in ²)	(in ⁴)	(in ⁴)	(lbf/ft)			Creep Factor
24.75	62.39	41.77	5.64	3	0.5	1

STRENGTH PROPERTIES

	F _b (psi)	F _t (psi)	F _v (psi)	F _c (psi)	F _{c⊥} (psi)	E (psi) x10 ³	E _{min} (psi) x10 ³
Base Values	900	575	180	1350	625	1600	580
Adjusted Values	1170	748	180	1485	625	1600	580
C _M	1	1	1	1	1	1	1
C _T	1	1	1	1	1	1	1
C _i	1	1	1	1	1	1	1
C _F	1.3	1.3	1	1.1	1	1	1

Bending Adjustment Factors C_{fu} = 1 C_r = 1**COLUMN DATA**

Span	Length (ft)	Unbraced Length (ft)		Column End					
		X	Y	Offset	CP	Ke(X Axis)	Ke(Y Axis)	KeL/d (X Axis)	KeL/d (Y Axis)
1	9	9	9	0	0.35	1.00	1.00	19.64	24

PASS-FAIL

	PASS/FAIL	MAGNITUDE	STRENGTH	LOCATION (ft)	LOAD COMBO	DURATION FACTOR CD
Deflection (in)	PASS (98.4%)	0.010 (=L/11368)	0.600 (=L/180)	9	L	
Compressive Stress (psi)	PASS (55.2%)	235.8	526.4	0	D+L	1

REACTIONS

Units for V: lbf Units for M: lbf-ft

Z axis	DEAD	LIVE	TOTAL
A	2349	3486	5835
B	0	0	0

Reaction Location

**LOAD LIST**

Type	Name	Left Magnitude	Right Magnitude	Load Start (ft)	Load End (ft)	Load Type	Direction
Self Weight (lbf/ft)	-	5.64	5.64	0	9	Dead	Z

LINKED LOAD LIST

Type	Left Magnitude	Right Magnitude	Load Start (ft)	Load End (ft)	Load Type	Direction
Axial (lbf)	-67.20981	-67.20981	9	9	Dead	Z
Axial (lbf)	-1106.751	-1106.751	9	9	Dead	Z
Axial (lbf)	-1740	-1740	9	9	Live	Z
Axial (lbf)	-1124.664	-1124.664	9	9	Dead	Z
Axial (lbf)	-1746	-1746	9	9	Live	Z

DATE:	3/24/2023	COMPANY:	Architects Northwest
STRUCALC BUILD:	StruCalc Plus	DESIGNED BY:	Sarah Weight
CUSTOMER:	Phan-Nguyen	REVIEWED BY:	Sarah Weight
PROJ. ADDRESS:	--	PROJECT NAME:	Phan-Nguyen
	, Mercer Island, WA		
LEVEL:	StruCalc Members	LOADING:	ASD
MEMBER NAME:	C29 - COL at R01b, U01b, & M01b	CODE:	2018 International Building Code
MEMBER TYPE:	COLUMN	NDS:	2018 NDS
MATERIAL:	Solid Sawn		
Douglas Fir-Larch	No. 2	(3) 1.5 X 5.5	DRY

C29 - COL at R01b, U01b, & M01b DIAGRAM

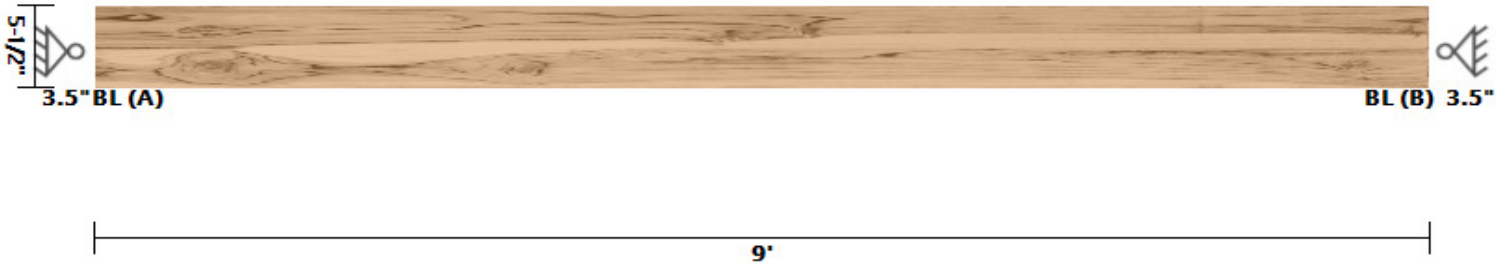

COLUMN PROPERTIES

Start(ft) 0 End(ft): 9

Area	Ix	Iy	BSW	Lams	G	Kcr
(in ²)	(in ⁴)	(in ⁴)	(lbf/ft)			Creep Factor
24.75	62.39	41.77	5.64	3	0.5	1

STRENGTH PROPERTIES

	Fb (psi)	Ft (psi)	Fv (psi)	Fc (psi)	Fc⊥ (psi)	E (psi) x10 ³	Emin (psi) x10 ³
Base Values	900	575	180	1350	625	1600	580
Adjusted Values	1170	748	180	1485	625	1600	580
C _M	1	1	1	1	1	1	1
C _T	1	1	1	1	1	1	1
C _i	1	1	1	1	1	1	1
C _F	1.3	1.3	1	1.1	1	1	1

Bending Adjustment Factors C_{fu} = 1 C_r = 1

COLUMN DATA

Span	Length (ft)	Unbraced Length (ft)		Column End					
		X	Y	Offset	CP	Ke(X Axis)	Ke(Y Axis)	KeL/d (X Axis)	KeL/d (Y Axis)
1	9	9	9	0	0.35	1.00	1.00	19.64	24

PASS-FAIL

	PASS/FAIL	MAGNITUDE	STRENGTH	LOCATION (ft)	LOAD COMBO	DURATION FACTOR CD
Deflection (in)	PASS (98.4%)	0.010 (=L/11368)	0.600 (=L/180)	9	L	
Compressive Stress (psi)	PASS (55.2%)	236.0	526.4	0	D+L	1

REACTIONS

Units for V: lbf Units for M: lbf-ft

Z axis	DEAD	LIVE	TOTAL
A	2355	3486	5841
B	0	0	0

Reaction Location



LOAD LIST

Type	Name	Left Magnitude	Right Magnitude	Load Start (ft)	Load End (ft)	Load Type	Direction
Self Weight (lbf/ft)	-	5.64	5.64	0	9	Dead	Z

LINKED LOAD LIST

Type	Left Magnitude	Right Magnitude	Load Start (ft)	Load End (ft)	Load Type	Direction
Axial (lbf)	-72.65992	-72.65992	9	9	Dead	Z
Axial (lbf)	-1106.751	-1106.751	9	9	Dead	Z
Axial (lbf)	-1740	-1740	9	9	Live	Z
Axial (lbf)	-1124.664	-1124.664	9	9	Dead	Z
Axial (lbf)	-1746	-1746	9	9	Live	Z

DATE:	3/24/2023	COMPANY:	Architects Northwest
STRUCALC BUILD:	StruCalc Plus	DESIGNED BY:	Sarah Weight
CUSTOMER:	Phan-Nguyen	REVIEWED BY:	Sarah Weight
PROJ. ADDRESS:	-- Mercer Island, WA	PROJECT NAME:	Phan-Nguyen
LEVEL:	StruCalc Members	LOADING:	ASD
MEMBER NAME:	C30 - COL at R02ab, M04ab, & OT	CODE:	2018 International Building Code
MEMBER TYPE:	COLUMN	NDS:	2018 NDS
MATERIAL:	Solid Sawn		
Douglas Fir-Larch	No. 2	(1) 5.5 X 7.5	DRY

C30 - COL at R02ab, M04ab, & OT DIAGRAM

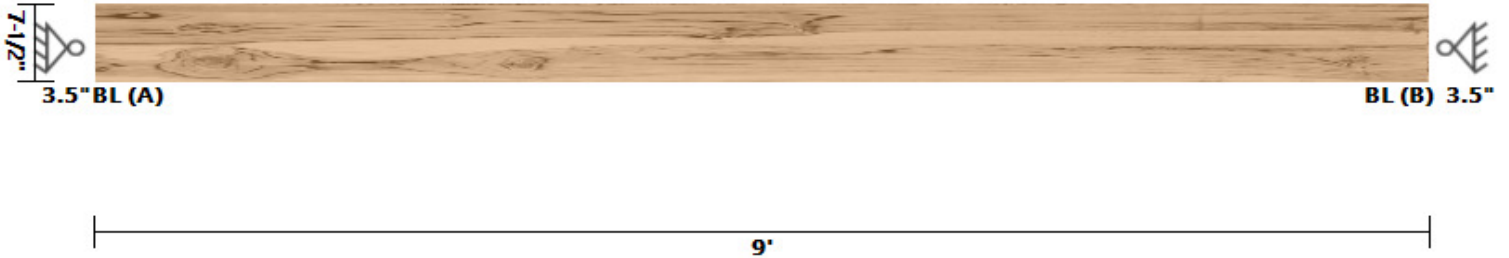

COLUMN PROPERTIES

Start(ft) 0 End(ft): 9

Area	Ix	Iy	BSW	Lams	G	Kcr
(in ²)	(in ⁴)	(in ⁴)	(lbf/ft)			Creep Factor
41.25	193.36	103.98	9.41	1	0.5	1

STRENGTH PROPERTIES

	Fb (psi)	Ft (psi)	Fv (psi)	Fc (psi)	Fc⊥ (psi)	E (psi) x10 ³	Emin (psi) x10 ³
Base Values	750	475	170	700	625	1300	470
Adjusted Values	750	475	170	700	625	1300	470
C _M	1	1	1	1	1	1	1
C _T	1	1	1	1	1	1	1
C _i	1	1	1	1	1	1	1
C _F	1	1	1	1	1	1	1

Bending Adjustment Factors C_{fu} = 1 C_r = 1

COLUMN DATA

Span	Length (ft)	Unbraced Length (ft)		Column End					
		X	Y	Offset	CP	Ke(X Axis)	Ke(Y Axis)	KeL/d (X Axis)	KeL/d (Y Axis)
1	9	9	9	0	0.80	1.00	1.00	14.4	19.64

PASS-FAIL

	PASS/FAIL	MAGNITUDE	STRENGTH	LOCATION (ft)	LOAD COMBO	DURATION FACTOR CD
Deflection (in)	PASS (96.4%)	0.022 (=L/4954)	0.600 (=L/180)	9	D+L	
Compressive Stress (psi)	PASS (52.8%)	263.6	559.0	0	D+L	1

REACTIONS

Units for V: lbf Units for M: lbf-ft

Z axis	DEAD	LIVE	TOTAL
A	2194	8680	10874
B	0	0	0

Reaction Location



LOAD LIST

Type	Name	Left Magnitude	Right Magnitude	Load Start (ft)	Load End (ft)	Load Type	Direction
Axial (lbf)	OT	-5690	-5690	9	9	Live	Z
Self Weight (lbf/ft)	-	9.41	9.41	0	9	Dead	Z

LINKED LOAD LIST

Type	Left Magnitude	Right Magnitude	Load Start (ft)	Load End (ft)	Load Type	Direction
Axial (lbf)	-119.2237	-119.2237	9	9	Dead	Z
Axial (lbf)	-1990.236	-1990.236	9	9	Dead	Z
Axial (lbf)	-2990	-2990	9	9	Live	Z

PASS

DATE:	3/24/2023	COMPANY:	Architects Northwest
STRUCALC BUILD:	StruCalc Plus	DESIGNED BY:	Sarah Weight
CUSTOMER:	Phan-Nguyen	REVIEWED BY:	Sarah Weight
PROJ. ADDRESS:	-- Mercer Island, WA	PROJECT NAME:	Phan-Nguyen
LEVEL:	StruCalc Members	LOADING:	ASD
MEMBER NAME:	C31 - COL at M03a	CODE:	2018 International Building Code
MEMBER TYPE:	COLUMN	NDS:	2018 NDS
MATERIAL:	Solid Sawn		
Douglas Fir-Larch	No. 2	(1) 5.5 X 5.5	DRY

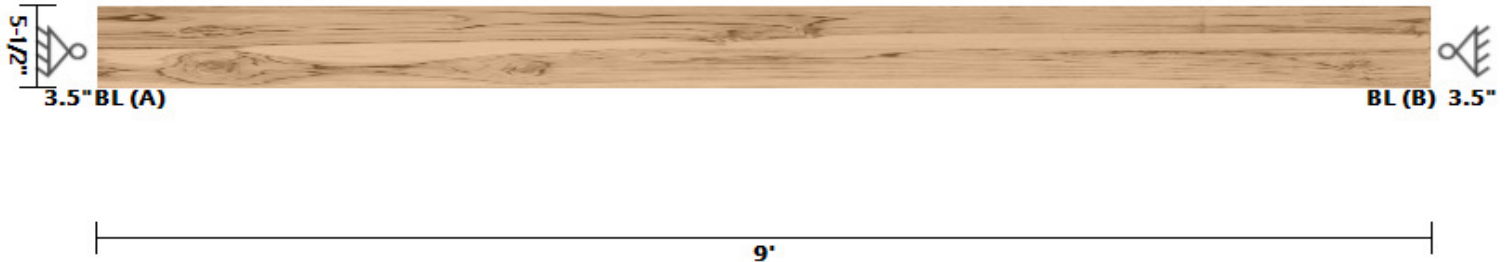
C31 - COL at M03a DIAGRAM**COLUMN PROPERTIES**

Start(ft) 0 End(ft): 9

Area	I _x	I _y	BSW	Lams	G	K _{cr}
(in ²)	(in ⁴)	(in ⁴)	(lbf/ft)			Creep Factor
30.25	76.26	76.26	6.9	1	0.5	1

STRENGTH PROPERTIES

	F _b (psi)	F _t (psi)	F _v (psi)	F _c (psi)	F _{c⊥} (psi)	E (psi) x10 ³	E _{min} (psi) x10 ³
Base Values	750	475	170	700	625	1300	470
Adjusted Values	750	475	170	700	625	1300	470
C _M	1	1	1	1	1	1	1
C _T	1	1	1	1	1	1	1
C _i	1	1	1	1	1	1	1
C _F	1	1	1	1	1	1	1

Bending Adjustment Factors C_{fu} = 1 C_r = 1**COLUMN DATA**

Span	Length (ft)	Unbraced Length (ft)		Column End					
		X	Y	Offset	CP	Ke(X Axis)	Ke(Y Axis)	KeL/d (X Axis)	KeL/d (Y Axis)
1	9	9	9	0	0.80	1.00	1.00	19.64	19.64

PASS-FAIL

	PASS/FAIL	MAGNITUDE	STRENGTH	LOCATION (ft)	LOAD COMBO	DURATION FACTOR CD
Deflection (in)	PASS (97.8%)	0.013 (=L/8182)	0.600 (=L/180)	9	L	
Compressive Stress (psi)	PASS (54.2%)	255.8	559.0	0	D+L	1

REACTIONS

Units for V: lbf Units for M: lbf-ft

Z axis	DEAD	LIVE	TOTAL
A	2949	4790	7739
B	0	0	0

Reaction Location

**LOAD LIST**

Type	Name	Left Magnitude	Right Magnitude	Load Start (ft)	Load End (ft)	Load Type	Direction
Self Weight (lbf/ft)	-	6.9	6.9	0	9	Dead	Z

LINKED LOAD LIST

Type	Left Magnitude	Right Magnitude	Load Start (ft)	Load End (ft)	Load Type	Direction
Axial (lbf)	-2887.162	-2887.162	9	9	Dead	Z
Axial (lbf)	-4789.708	-4789.708	9	9	Live	Z

PASS

DATE:	3/24/2023	COMPANY:	Architects Northwest
STRUCALC BUILD:	StruCalc Plus	DESIGNED BY:	Sarah Weight
CUSTOMER:	Phan-Nguyen	REVIEWED BY:	Sarah Weight
PROJ. ADDRESS:	--	PROJECT NAME:	Phan-Nguyen
	, Mercer Island, WA		
LEVEL:	StruCalc Members	LOADING:	ASD
MEMBER NAME:	C32 - COL at M03b& U03a	CODE:	2018 International Building Code
MEMBER TYPE:	COLUMN	NDS:	2018 NDS
MATERIAL:	Solid Sawn		
Douglas Fir-Larch	No. 2	(1) 5.5 X 5.5	DRY

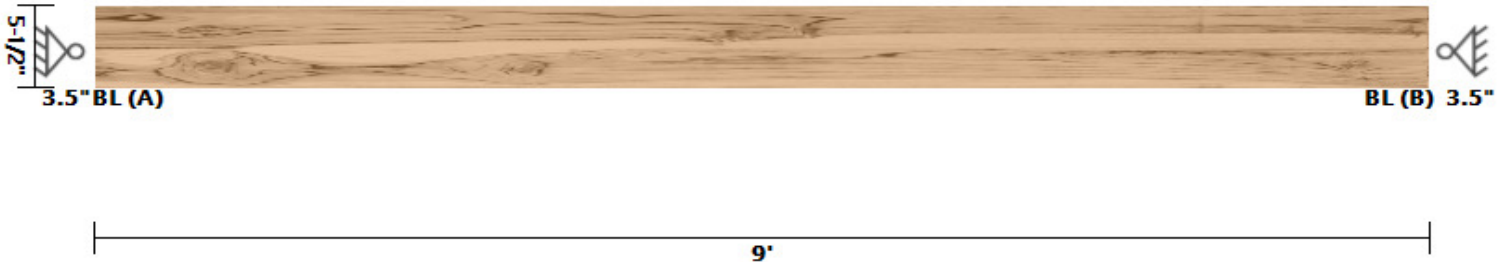
C32 - COL at M03b& U03a DIAGRAM**COLUMN PROPERTIES**

Start(ft) 0 End(ft): 9

Area	I _x	I _y	BSW	Lams	G	K _{cr}
(in ²)	(in ⁴)	(in ⁴)	(lbf/ft)			Creep Factor
30.25	76.26	76.26	6.9	1	0.5	1

STRENGTH PROPERTIES

	F _b (psi)	F _t (psi)	F _v (psi)	F _c (psi)	F _{c⊥} (psi)	E (psi) x10 ³	E _{min} (psi) x10 ³
Base Values	750	475	170	700	625	1300	470
Adjusted Values	750	475	170	700	625	1300	470
C _M	1	1	1	1	1	1	1
C _T	1	1	1	1	1	1	1
C _i	1	1	1	1	1	1	1
C _F	1	1	1	1	1	1	1

Bending Adjustment Factors C_{fu} = 1 C_r = 1**COLUMN DATA**

Span	Length (ft)	Unbraced Length (ft)		Column End					
		X	Y	Offset	CP	Ke(X Axis)	Ke(Y Axis)	KeL/d (X Axis)	KeL/d (Y Axis)
1	9	9	9	0	0.80	1.00	1.00	19.64	19.64

PASS-FAIL

	PASS/FAIL	MAGNITUDE	STRENGTH	LOCATION (ft)	LOAD COMBO	DURATION FACTOR CD
Deflection (in)	PASS (97.2%)	0.017 (=L/6545)	0.600 (=L/180)	9	L	
Compressive Stress (psi)	PASS (37.3%)	350.6	559.0	0	D+L	1

REACTIONS

Units for V: lbf Units for M: lbf-ft

Z axis	DEAD	LIVE	TOTAL
A	4597	6010	10607
B	0	0	0

Reaction Location

A

B

LOAD LIST

Type	Name	Left Magnitude	Right Magnitude	Load Start (ft)	Load End (ft)	Load Type	Direction
Self Weight (lbf/ft)	-	6.9	6.9	0	9	Dead	Z

LINKED LOAD LIST

Type	Left Magnitude	Right Magnitude	Load Start (ft)	Load End (ft)	Load Type	Direction
Axial (lbf)	-1264.656	-1264.656	9	9	Dead	Z
Axial (lbf)	-955.9999	-955.9999	9	9	Live	Z
Axial (lbf)	-3269.913	-3269.913	9	9	Dead	Z
Axial (lbf)	-5054.292	-5054.292	9	9	Live	Z

DATE:	3/24/2023	COMPANY:	Architects Northwest
STRUCALC BUILD:	StruCalc Plus	DESIGNED BY:	Sarah Weight
CUSTOMER:	Phan-Nguyen	REVIEWED BY:	Sarah Weight
PROJ. ADDRESS:	-- Mercer Island, WA	PROJECT NAME:	Phan-Nguyen
LEVEL:	StruCalc Members	LOADING:	ASD
MEMBER NAME:	C33 - COL at M05.OT1a	CODE:	2018 International Building Code
MEMBER TYPE:	COLUMN	NDS:	2018 NDS
MATERIAL:	Solid Sawn		
Douglas Fir-Larch	No. 2	(3) 1.5 X 5.5	DRY

C33 - COL at M05.OT1a DIAGRAM

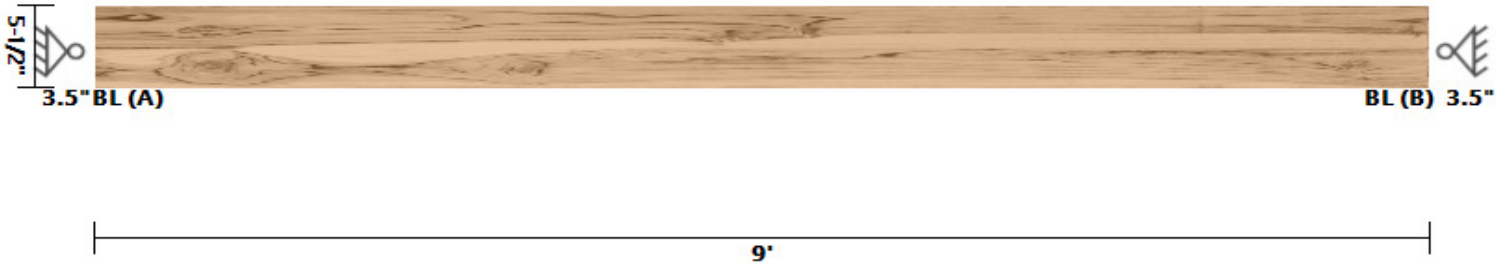

COLUMN PROPERTIES

Start(ft) 0 End(ft): 9

Area	Ix	Iy	BSW	Lams	G	Kcr
(in ²)	(in ⁴)	(in ⁴)	(lbf/ft)			Creep Factor
24.75	62.39	41.77	5.64	3	0.5	1

STRENGTH PROPERTIES

	Fb (psi)	Ft (psi)	Fv (psi)	Fc (psi)	Fc⊥ (psi)	E (psi) x10 ³	Emin (psi) x10 ³
Base Values	900	575	180	1350	625	1600	580
Adjusted Values	1170	748	180	1485	625	1600	580
C _M	1	1	1	1	1	1	1
C _T	1	1	1	1	1	1	1
C _i	1	1	1	1	1	1	1
C _F	1.3	1.3	1	1.1	1	1	1

Bending Adjustment Factors C_{fu} = 1 C_r = 1

COLUMN DATA

Span	Length (ft)	Unbraced Length (ft)		Column End					
		X	Y	Offset	CP	Ke(X Axis)	Ke(Y Axis)	KeL/d (X Axis)	KeL/d (Y Axis)
1	9	9	9	0	0.38	1.00	1.00	19.64	24

PASS-FAIL

	PASS/FAIL	MAGNITUDE	STRENGTH	LOCATION (ft)	LOAD COMBO	DURATION FACTOR CD
Compressive Stress (psi)	PASS (99.3%)	3.7	513.1	0	D	0.9

REACTIONS

Units for V: lbf Units for M: lbf-ft

Z axis	DEAD	TOTAL
A	92	92
B	0	0

Reaction Location

A

B

LOAD LIST

Type	Name	Left Magnitude	Right Magnitude	Load Start (ft)	Load End (ft)	Load Type	Direction
Self Weight (lbf/ft)	-	5.64	5.64	0	9	Dead	Z

LINKED LOAD LIST

Type	Left Magnitude	Right Magnitude	Load Start (ft)	Load End (ft)	Load Type	Direction
Axial (lbf)	-41.11464	-41.11464	9	9	Dead	Z

PASS

DATE:	3/24/2023	COMPANY:	Architects Northwest
STRUCALC BUILD:	StruCalc Plus	DESIGNED BY:	Sarah Weight
CUSTOMER:	Phan-Nguyen	REVIEWED BY:	Sarah Weight
PROJ. ADDRESS:	-- Mercer Island, WA	PROJECT NAME:	Phan-Nguyen
LEVEL:	StruCalc Members	LOADING:	ASD
MEMBER NAME:	C34 - COL at M05.OT1b	CODE:	2018 International Building Code
MEMBER TYPE:	COLUMN	NDS:	2018 NDS
MATERIAL:	Solid Sawn		
Douglas Fir-Larch	No. 2	(3) 1.5 X 5.5	DRY

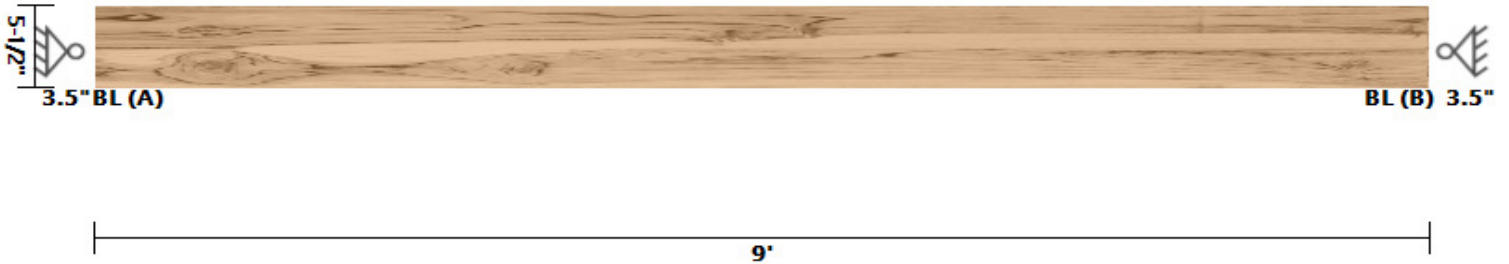
C34 - COL at M05.OT1b DIAGRAM**COLUMN PROPERTIES**

Start(ft) 0 End(ft): 9

Area	I _x	I _y	BSW	Lams	G	K _{cr}
(in ²)	(in ⁴)	(in ⁴)	(lb/ft)			Creep Factor
24.75	62.39	41.77	5.64	3	0.5	1

STRENGTH PROPERTIES

	F _b (psi)	F _t (psi)	F _v (psi)	F _c (psi)	F _{c⊥} (psi)	E (psi) x10 ³	E _{min} (psi) x10 ³
Base Values	900	575	180	1350	625	1600	580
Adjusted Values	1170	748	180	1485	625	1600	580
C _M	1	1	1	1	1	1	1
C _T	1	1	1	1	1	1	1
C _i	1	1	1	1	1	1	1
C _F	1.3	1.3	1	1.1	1	1	1

Bending Adjustment Factors C_{fu} = 1 C_r = 1**COLUMN DATA**

Span	Length (ft)	Unbraced Length (ft)		Column End					
		X	Y	Offset	CP	Ke(X Axis)	Ke(Y Axis)	KeL/d (X Axis)	KeL/d (Y Axis)
1	9	9	9	0	0.38	1.00	1.00	19.64	24

PASS-FAIL

	PASS/FAIL	MAGNITUDE	STRENGTH	LOCATION (ft)	LOAD COMBO	DURATION FACTOR CD
Compressive Stress (psi)	PASS (99.3%)	3.7	513.1	0	D	0.9

REACTIONS

Units for V: lbf Units for M: lbf-ft

Z axis	DEAD	TOTAL
A	92	92
B	0	0

Reaction Location

A

B

LOAD LIST

Type	Name	Left Magnitude	Right Magnitude	Load Start (ft)	Load End (ft)	Load Type	Direction
Self Weight (lb/ft)	-	5.64	5.64	0	9	Dead	Z

LINKED LOAD LIST

Type	Left Magnitude	Right Magnitude	Load Start (ft)	Load End (ft)	Load Type	Direction
Axial (lbf)	-41.11464	-41.11464	9	9	Dead	Z

PASS

DATE:	3/24/2023	COMPANY:	Architects Northwest
STRUCALC BUILD:	StruCalc Plus	DESIGNED BY:	Sarah Weight
CUSTOMER:	Phan-Nguyen	REVIEWED BY:	Sarah Weight
PROJ. ADDRESS:	--	PROJECT NAME:	Phan-Nguyen
	, Mercer Island, WA		
LEVEL:	StruCalc Members	LOADING:	ASD
MEMBER NAME:	C35 - COL at M06a	CODE:	2018 International Building Code
MEMBER TYPE:	COLUMN	NDS:	2018 NDS
MATERIAL:	Solid Sawn		
Douglas Fir-Larch	No. 2	(1) 3.5 X 5.5	DRY

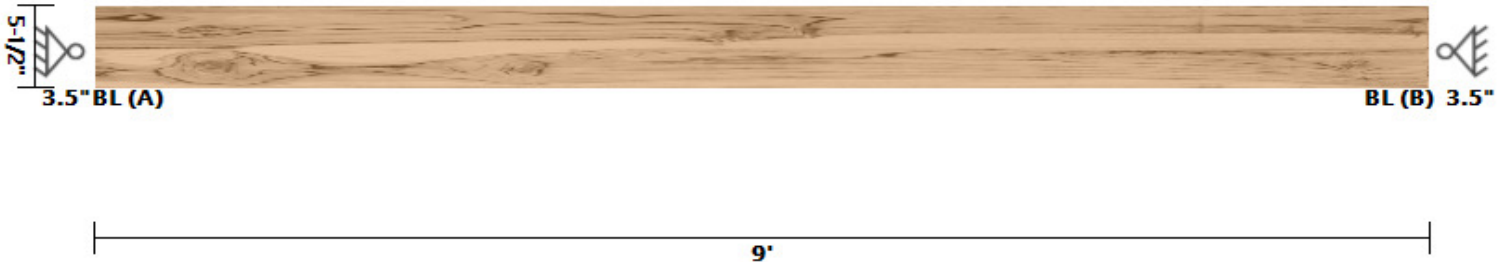
C35 - COL at M06a DIAGRAM**COLUMN PROPERTIES**

Start(ft) 0 End(ft): 9

Area	I _x	I _y	BSW	Lams	G	K _{cr}
(in ²)	(in ⁴)	(in ⁴)	(lb/ft)			Creep Factor
19.25	48.53	19.65	4.39	1	0.5	1

STRENGTH PROPERTIES

	F _b (psi)	F _t (psi)	F _v (psi)	F _c (psi)	F _{c⊥} (psi)	E (psi) x10 ³	E _{min} (psi) x10 ³
Base Values	900	575	180	1350	625	1600	580
Adjusted Values	1170	748	180	1485	625	1600	580
C _M	1	1	1	1	1	1	1
C _T	1	1	1	1	1	1	1
C _i	1	1	1	1	1	1	1
C _F	1.3	1.3	1	1.1	1	1	1

Bending Adjustment Factors C_{fu} = 1 C_r = 1**COLUMN DATA**

Span	Length (ft)	Unbraced Length (ft)		Column End					
		X	Y	Offset	CP	Ke(X Axis)	Ke(Y Axis)	KeL/d (X Axis)	KeL/d (Y Axis)
1	9	9	9	0	0.34	1.00	1.00	19.64	30.86

PASS-FAIL

	PASS/FAIL	MAGNITUDE	STRENGTH	LOCATION (ft)	LOAD COMBO	DURATION FACTOR CD
Compressive Stress (psi)	PASS (98.6%)	6.5	454.0	0	D	0.9

REACTIONS

Units for V: lbf Units for M: lbf-ft

Z axis	DEAD	TOTAL
A	126	126
B	0	0

Reaction Location

A

B

LOAD LIST

Type	Name	Left Magnitude	Right Magnitude	Load Start (ft)	Load End (ft)	Load Type	Direction
Self Weight (lb/ft)	-	4.39	4.39	0	9	Dead	Z

LINKED LOAD LIST

Type	Left Magnitude	Right Magnitude	Load Start (ft)	Load End (ft)	Load Type	Direction
Axial (lbf)	-86.43503	-86.43503	9	9	Dead	Z

PASS

DATE:	3/24/2023	COMPANY:	Architects Northwest
STRUCALC BUILD:	StruCalc Plus	DESIGNED BY:	Sarah Weight
CUSTOMER:	Phan-Nguyen	REVIEWED BY:	Sarah Weight
PROJ. ADDRESS:	--	PROJECT NAME:	Phan-Nguyen
	, Mercer Island, WA		
LEVEL:	StruCalc Members	LOADING:	ASD
MEMBER NAME:	C36 - COL at M06b	CODE:	2018 International Building Code
MEMBER TYPE:	COLUMN	NDS:	2018 NDS
MATERIAL:	Solid Sawn		
Douglas Fir-Larch	No. 2	(3) 1.5 X 5.5	DRY

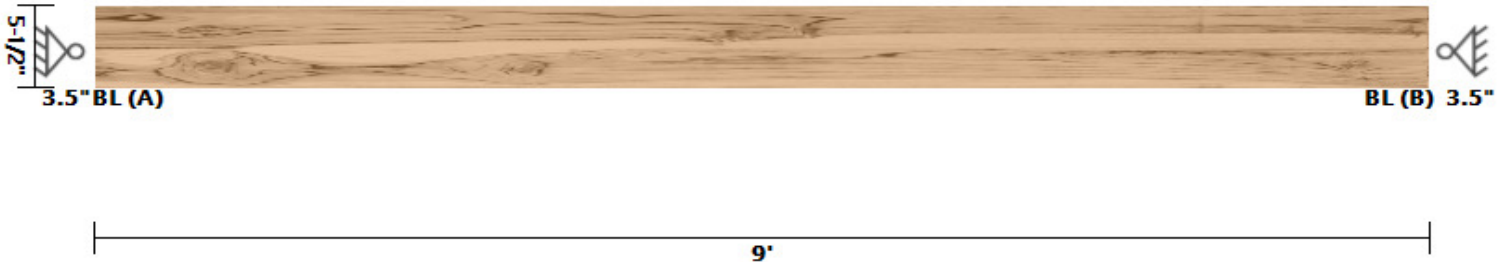
C36 - COL at M06b DIAGRAM**COLUMN PROPERTIES**

Start(ft) 0 End(ft): 9

Area	Ix	Iy	BSW	Lams	G	Kcr
(in ²)	(in ⁴)	(in ⁴)	(lbf/ft)			Creep Factor
24.75	62.39	41.77	5.64	3	0.5	1

STRENGTH PROPERTIES

	Fb (psi)	Ft (psi)	Fv (psi)	Fc (psi)	Fc _⊥ (psi)	E (psi) x10 ³	Emin (psi) x10 ³
Base Values	900	575	180	1350	625	1600	580
Adjusted Values	1170	748	180	1485	625	1600	580
C _M	1	1	1	1	1	1	1
C _T	1	1	1	1	1	1	1
C _i	1	1	1	1	1	1	1
C _F	1.3	1.3	1	1.1	1	1	1

Bending Adjustment Factors C_{fu} = 1 C_r = 1**COLUMN DATA**

Span	Length (ft)	Unbraced Length (ft)		Column End					
		X	Y	Offset	CP	Ke(X Axis)	Ke(Y Axis)	KeL/d (X Axis)	KeL/d (Y Axis)
1	9	9	9	0	0.38	1.00	1.00	19.64	24

PASS-FAIL

	PASS/FAIL	MAGNITUDE	STRENGTH	LOCATION (ft)	LOAD COMBO	DURATION FACTOR CD
Compressive Stress (psi)	PASS (98.9%)	5.5	513.1	0	D	0.9

REACTIONS

Units for V: lbf Units for M: lbf-ft

Z axis	DEAD	TOTAL
A	137	137
B	0	0

Reaction Location

A

B

LOAD LIST

Type	Name	Left Magnitude	Right Magnitude	Load Start (ft)	Load End (ft)	Load Type	Direction
Self Weight (lbf/ft)	-	5.64	5.64	0	9	Dead	Z

LINKED LOAD LIST

Type	Left Magnitude	Right Magnitude	Load Start (ft)	Load End (ft)	Load Type	Direction
Axial (lbf)	-86.43503	-86.43503	9	9	Dead	Z

DATE:	3/24/2023	COMPANY:	Architects Northwest
STRUCALC BUILD:	StruCalc Plus	DESIGNED BY:	Sarah Weight
CUSTOMER:	Phan-Nguyen	REVIEWED BY:	Sarah Weight
PROJ. ADDRESS:	--	PROJECT NAME:	Phan-Nguyen
	, Mercer Island, WA		
LEVEL:	StruCalc Members	LOADING:	ASD
MEMBER NAME:	C37 - COL at M08ab	CODE:	2018 International Building Code
MEMBER TYPE:	COLUMN	NDS:	2018 NDS
MATERIAL:	Solid Sawn		
Douglas Fir-Larch	No. 2	(3) 1.5 X 5.5	DRY

C37 - COL at M08ab DIAGRAM

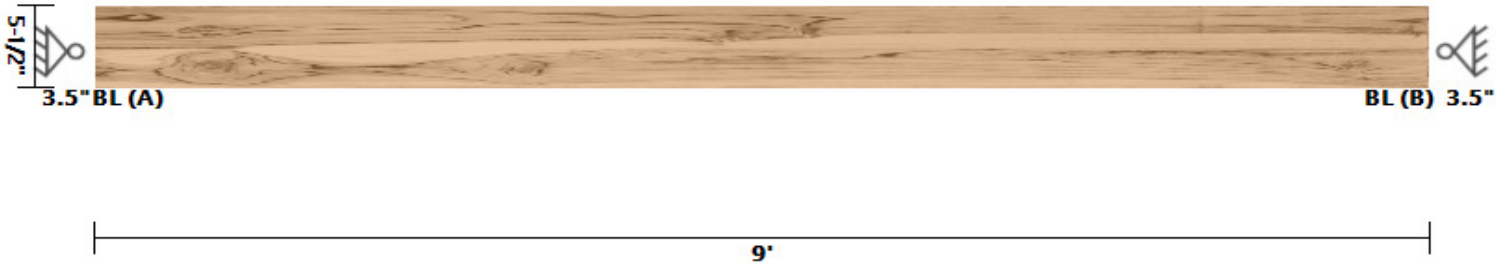

COLUMN PROPERTIES

Start(ft) 0 End(ft): 9

Area	Ix	Iy	BSW	Lams	G	Kcr
(in ²)	(in ⁴)	(in ⁴)	(lbf/ft)			Creep Factor
24.75	62.39	41.77	5.64	3	0.5	1

STRENGTH PROPERTIES

	Fb (psi)	Ft (psi)	Fv (psi)	Fc (psi)	Fc⊥ (psi)	E (psi) x10 ³	Emin (psi) x10 ³
Base Values	900	575	180	1350	625	1600	580
Adjusted Values	1170	748	180	1485	625	1600	580
C _M	1	1	1	1	1	1	1
C _T	1	1	1	1	1	1	1
C _i	1	1	1	1	1	1	1
C _F	1.3	1.3	1	1.1	1	1	1

Bending Adjustment Factors C_{fu} = 1 C_r = 1

COLUMN DATA

Span	Length (ft)	Unbraced Length (ft)		Column End					
		X	Y	Offset	CP	Ke(X Axis)	Ke(Y Axis)	KeL/d (X Axis)	KeL/d (Y Axis)
1	9	9	9	0	0.30	1.00	1.00	19.64	24

PASS-FAIL

	PASS/FAIL	MAGNITUDE	STRENGTH	LOCATION (ft)	LOAD COMBO	DURATION FACTOR CD
Deflection (in)	PASS (99.4%)	0.004 (=L/30000)	0.600 (=L/180)	9	Lr	
Compressive Stress (psi)	PASS (78.5%)	118.3	549.2	0	D+Lr	1.25

REACTIONS

Units for V: lbf Units for M: lbf-ft

Z axis	DEAD	LIVE	LIVE ROOF	TOTAL
A	1610	268	1318	3196
B	0	0	0	0

Reaction Location



LOAD LIST

Type	Name	Left Magnitude	Right Magnitude	Load Start (ft)	Load End (ft)	Load Type	Direction
Self Weight (lbf/ft)	-	5.64	5.64	0	9	Dead	Z

LINKED LOAD LIST

Type	Left Magnitude	Right Magnitude	Load Start (ft)	Load End (ft)	Load Type	Direction
Axial (lbf)	-1558.763	-1558.763	9	9	Dead	Z
Axial (lbf)	-268	-268	9	9	Live	Z
Axial (lbf)	-1318.359	-1318.359	9	9	RoofLive	Z

PASS

DATE:	3/24/2023	COMPANY:	Architects Northwest
STRUCALC BUILD:	StruCalc Plus	DESIGNED BY:	Sarah Weight
CUSTOMER:	Phan-Nguyen	REVIEWED BY:	Sarah Weight
PROJ. ADDRESS:	-- Mercer Island, WA	PROJECT NAME:	Phan-Nguyen
LEVEL:	StruCalc Members	LOADING:	
MEMBER NAME:	F01 - FTG at R01a, U01a, & M01a (C2...	CODE:	2018 International Building Code
MEMBER TYPE:	ISOLATED FOOTING	ACI:	ACI 318-14
MATERIAL:	Concrete		
2.5 (ft) X 2.5 (ft) X 10 (in)		Soil Depth TOF: 0 (ft)	(3) #4 Long, (4) #4 Short

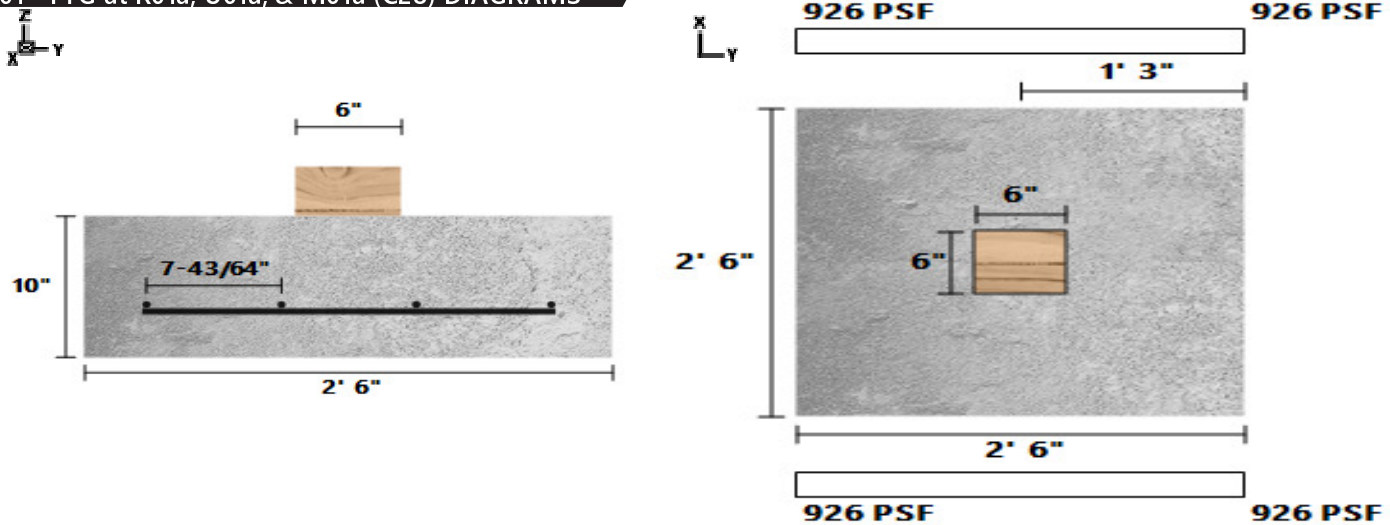
F01 - FTG at R01a, U01a, & M01a (C28) DIAGRAMS**MATERIAL PROPERTIES**

FOOTING						
fc' (psi)	Ec (psi)	Density (lbf/ft ³)	Width (ft)	Length (ft)	Depth (in)	Volume (ft ³)
2500	2880952	145	2.5	2.5	10	5.21
CALCULATION VARIABLES						
Bo (in)	Φ-X	Φ-Y				
50	0	0				
COLUMN						
Width (in)	Length (in)	Material	Offset (in)			
6	6	Wood	0			
SOIL						
Bearing Strength (lbf/ft ²)	Density (lbf/ft ³)	Cohesion	Friction Angle	Depth (ft)	Rankine Coefficient (Kp)	
1500	120	0	30	0	3	
REBAR						
Bar Size #	# Bars Long	# Bars Short	fy (psi)	Es (psi)		
4	4	3	40000	2.9E+07		

PASS-FAIL

	PASS/FAIL	MAGNITUDE	STRENGTH	LOAD COMBO
Soil Bearing Pressure (lbf/ft ²)	PASS (38.3%)	925.5	1500.0	D+L
Two-Way Shear (Punching) (lbf)	PASS (82.9%)	8335.9	48750.0	1.2D+1.6L+0.5Lr
One-Way Shear X (lbf)	PASS (89.6%)	1528.3	14625.0	1.2D+1.6L+0.5Lr
Moment X (lbf-ft)	PASS (58.3%)	1667.2	4000.0	1.2D+1.6L+0.5Lr
One-Way Shear Y (lbf)	PASS (89.6%)	1528.3	14625.0	1.2D+1.6L+0.5Lr
Moment Y (lbf-ft)	PASS (58.3%)	1667.2	4000.0	1.2D+1.6L+0.5Lr
Crushing (psi)	PASS (83.2%)	231.6	1381.3	1.2D+1.6L+0.5Lr

LOAD LIST

Type	Name	Left Magnitude	Right Magnitude	Load Start (ft)	Load End (ft)	Load Type	Direction
------	------	----------------	-----------------	-----------------	---------------	-----------	-----------

LINKED LOAD LIST

Type	Left Magnitude	Right Magnitude	Load Start (ft)	Load End (ft)	Load Type	Direction
Axial (lbf)	67.20981	67.20981	0	0	Dead	Z
Axial (lbf)	1106.751	1106.751	0	0	Dead	Z
Axial (lbf)	1740	1740	0	0	Live	Z
Axial (lbf)	1124.664	1124.664	0	0	Dead	Z
Axial (lbf)	1746	1746	0	0	Live	Z

PASS

DATE:	3/24/2023	COMPANY:	Architects Northwest
STRUCALC BUILD:	StruCalc Plus	DESIGNED BY:	Sarah Weight
CUSTOMER:	Phan-Nguyen	REVIEWED BY:	Sarah Weight
PROJ. ADDRESS:	-- Mercer Island, WA	PROJECT NAME:	Phan-Nguyen
LEVEL:	StruCalc Members	LOADING:	
MEMBER NAME:	F02 - FTG at R01b, U01b, & M01b (C2...	CODE:	2018 International Building Code
MEMBER TYPE:	ISOLATED FOOTING	ACI:	ACI 318-14
MATERIAL:	Concrete		
3 (ft) X 3 (ft) X 10 (in)		Soil Depth TOF: 0 (ft)	(4) #4 Long, (4) #4 Short

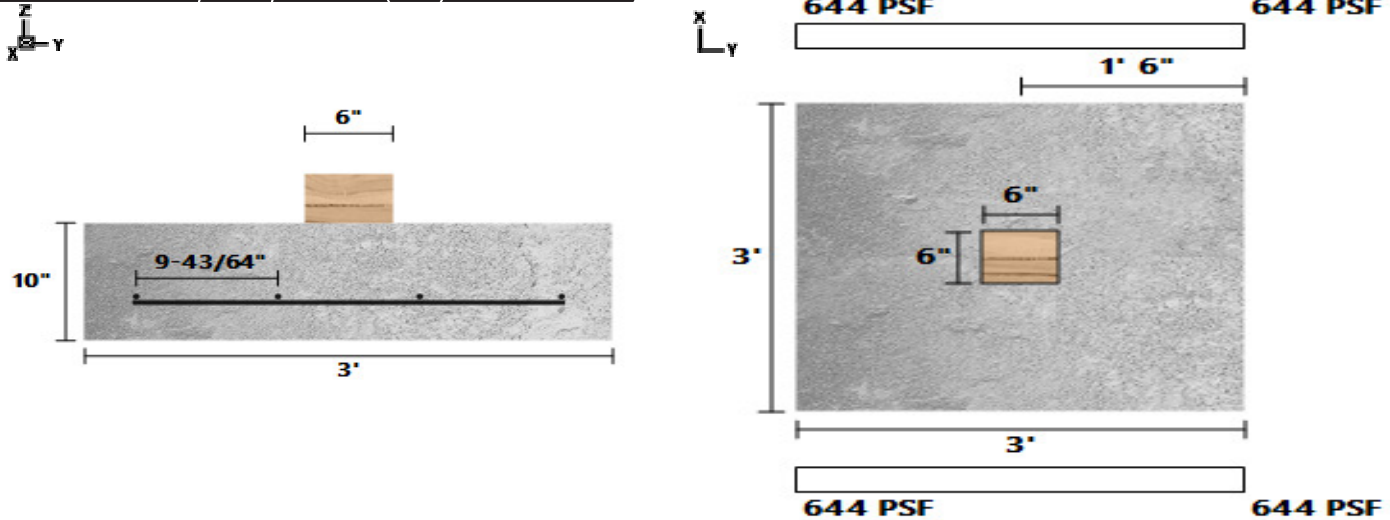
F02 - FTG at R01b, U01b, & M01b (C29) DIAGRAMS**MATERIAL PROPERTIES**

FOOTING						
fc' (psi)	Ec (psi)	Density (lbf/ft ³)	Width (ft)	Length (ft)	Depth (in)	Volume (ft ³)
2500	2880952	145	3	3	10	7.5
CALCULATION VARIABLES						
Bo (in)	Φ-X	Φ-Y				
50	0	0				
COLUMN						
Width (in)	Length (in)	Material	Offset (in)			
6	6	Wood	0			
SOIL						
Bearing Strength (lbf/ft ²)	Density (lbf/ft ³)	Cohesion	Friction Angle	Depth (ft)	Rankine Coefficient (Kp)	
1500	120	0	30	0	3	
REBAR						
Bar Size #	# Bars Long	# Bars Short	fy (psi)	Es (psi)		
4	4	4	40000	2.9E+07		

PASS-FAIL

	PASS/FAIL	MAGNITUDE	STRENGTH	LOAD COMBO
Soil Bearing Pressure (lbf/ft ²)	PASS (57.1%)	643.3	1500.0	D+L
Two-Way Shear (Punching) (lbf)	PASS (82.9%)	8342.5	48750.0	1.2D+1.6L+0.5Lr
One-Way Shear X (lbf)	PASS (88.8%)	1969.8	17550.0	1.2D+1.6L+0.5Lr
Moment X (lbf-ft)	PASS (85.6%)	2172.5	15098.0	1.2D+1.6L+0.5Lr
One-Way Shear Y (lbf)	PASS (88.8%)	1969.8	17550.0	1.2D+1.6L+0.5Lr
Moment Y (lbf-ft)	PASS (85.6%)	2172.5	15098.0	1.2D+1.6L+0.5Lr
Crushing (psi)	PASS (83.2%)	231.7	1381.3	1.2D+1.6L+0.5Lr

LOAD LIST

Type	Name	Left Magnitude	Right Magnitude	Load Start (ft)	Load End (ft)	Load Type	Direction
------	------	----------------	-----------------	-----------------	---------------	-----------	-----------

LINKED LOAD LIST

Type	Left Magnitude	Right Magnitude	Load Start (ft)	Load End (ft)	Load Type	Direction
Axial (lbf)	72.65992	72.65992	0	0	Dead	Z
Axial (lbf)	1106.751	1106.751	0	0	Dead	Z
Axial (lbf)	1740	1740	0	0	Live	Z
Axial (lbf)	1124.664	1124.664	0	0	Dead	Z
Axial (lbf)	1746	1746	0	0	Live	Z

PASS

DATE:	3/24/2023	COMPANY:	Architects Northwest
STRUCALC BUILD:	StruCalc Plus	DESIGNED BY:	Sarah Weight
CUSTOMER:	Phan-Nguyen	REVIEWED BY:	Sarah Weight
PROJ. ADDRESS:	-- Mercer Island, WA	PROJECT NAME:	Phan-Nguyen
LEVEL:	StruCalc Members	LOADING:	
MEMBER NAME:	F03 - FTG at GT7a (C02)	CODE:	2018 International Building Code
MEMBER TYPE:	ISOLATED FOOTING	ACI:	ACI 318-14
MATERIAL:	Concrete		
2.5 (ft) X 2.5 (ft) X 10 (in)		Soil Depth TOF: 0 (ft)	(3) #4 Long, (4) #4 Short

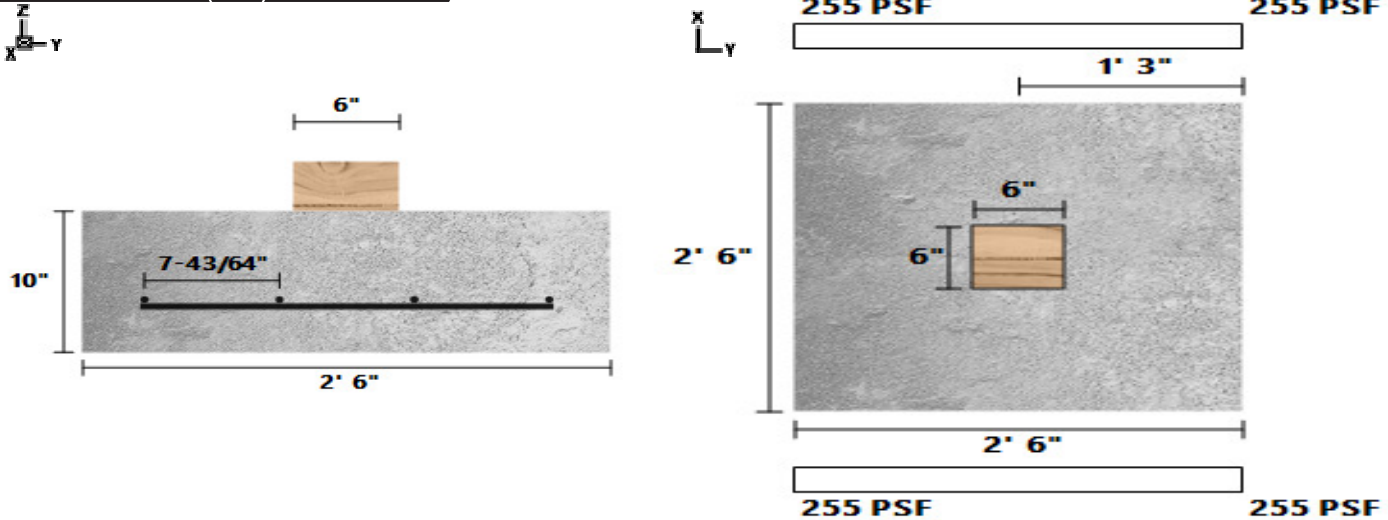
F03 - FTG at GT7a (C02) DIAGRAMS**MATERIAL PROPERTIES**

FOOTING						
fc' (psi)	Ec (psi)	Density (lbf/ft ³)	Width (ft)	Length (ft)	Depth (in)	Volume (ft ³)
2500	2880952	145	2.5	2.5	10	5.21
CALCULATION VARIABLES						
Bo (in)	Φ-X	Φ-Y				
50	0	0				
COLUMN						
Width (in)	Length (in)	Material	Offset (in)			
6	6	Wood	0			
SOIL						
Bearing Strength (lbf/ft ²)	Density (lbf/ft ³)	Cohesion	Friction Angle	Depth (ft)	Rankine Coefficient (Kp)	
1500	120	0	30	0	3	
REBAR						
Bar Size #	# Bars Long	# Bars Short	fy (psi)	Es (psi)		
4	4	3	40000	2.9E+07		

PASS-FAIL

	PASS/FAIL	MAGNITUDE	STRENGTH	LOAD COMBO
Soil Bearing Pressure (lbf/ft ²)	PASS (83.0%)	255.2	1500.0	D+Lr
Two-Way Shear (Punching) (lbf)	PASS (95.3%)	2302.2	48750.0	1.2D+1.6Lr+L
One-Way Shear X (lbf)	PASS (97.1%)	422.1	14625.0	1.2D+1.6Lr+L
Moment X (lbf-ft)	PASS (88.5%)	460.4	4000.0	1.2D+1.6Lr+L
One-Way Shear Y (lbf)	PASS (97.1%)	422.1	14625.0	1.2D+1.6Lr+L
Moment Y (lbf-ft)	PASS (88.5%)	460.4	4000.0	1.2D+1.6Lr+L
Crushing (psi)	PASS (95.4%)	63.9	1381.3	1.2D+1.6Lr+L

LOAD LIST

Type	Name	Left Magnitude	Right Magnitude	Load Start (ft)	Load End (ft)	Load Type	Direction
------	------	----------------	-----------------	-----------------	---------------	-----------	-----------

LINKED LOAD LIST

Type	Left Magnitude	Right Magnitude	Load Start (ft)	Load End (ft)	Load Type	Direction
Axial (lbf)	623.3502	623.3502	0	0	Dead	Z
Axial (lbf)	971.3389	971.3389	0	0	RoofLive	Z

PASS

DATE:	3/24/2023	COMPANY:	Architects Northwest
STRUCALC BUILD:	StruCalc Plus	DESIGNED BY:	Sarah Weight
CUSTOMER:	Phan-Nguyen	REVIEWED BY:	Sarah Weight
PROJ. ADDRESS:	-- Mercer Island, WA	PROJECT NAME:	Phan-Nguyen
LEVEL:	StruCalc Members	LOADING:	
MEMBER NAME:	F04 - FTG at R02ab, M04ab, & OT (C...	CODE:	2018 International Building Code
MEMBER TYPE:	ISOLATED FOOTING	ACI:	ACI 318-14
MATERIAL:	Concrete		
4 (ft) X 4 (ft) X 10 (in)		Soil Depth TOF: 0 (ft)	(5) #4 Long, (5) #4 Short

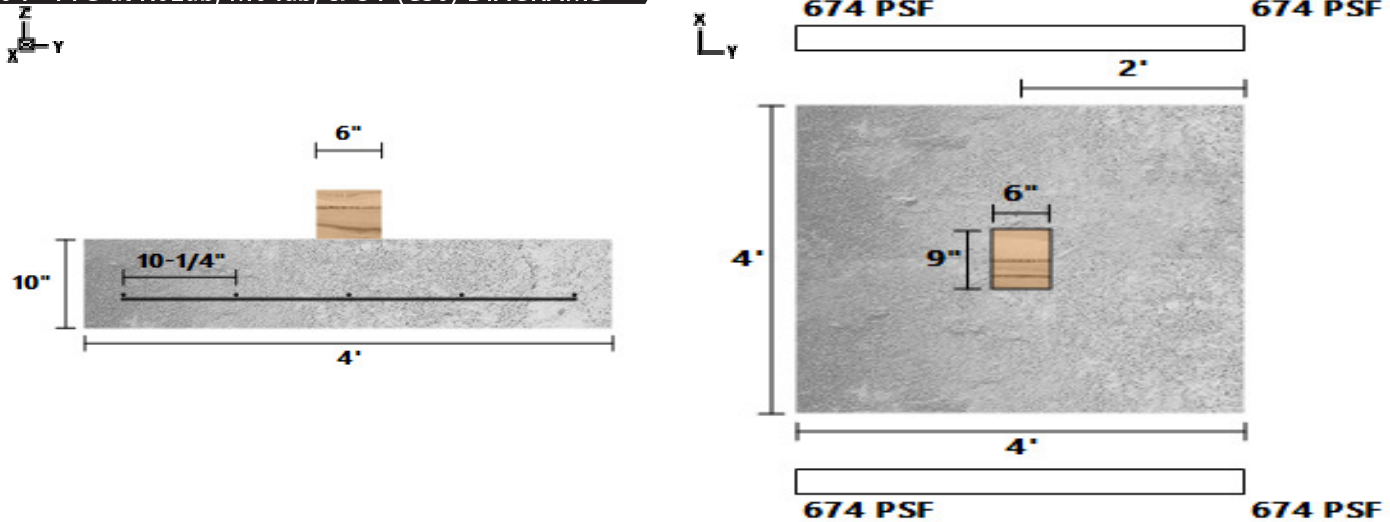
F04 - FTG at R02ab, M04ab, & OT (C30) DIAGRAMS**MATERIAL PROPERTIES**

FOOTING						
fc' (psi)	Ec (psi)	Density (lb/ft ³)	Width (ft)	Length (ft)	Depth (in)	Volume (ft ³)
2500	2880952	145	4	4	10	13.33
CALCULATION VARIABLES						
Bo (in)	Φ-X	Φ-Y				
56	0	0				
COLUMN						
Width (in)	Length (in)	Material	Offset (in)			
6	9	Wood	0			
SOIL						
Bearing Strength (lb/ft ²)	Density (lb/ft ³)	Cohesion	Friction Angle	Depth (ft)	Rankine Coefficient (Kp)	
1500	120	0	30	0	3	
REBAR						
Bar Size #	# Bars Long	# Bars Short	fy (psi)	Es (psi)		
4	5	5	40000	2.9E+07		

PASS-FAIL

	PASS/FAIL	MAGNITUDE	STRENGTH	LOAD COMBO
Soil Bearing Pressure (lb/ft ²)	PASS (55.0%)	674.3	1500.0	D+L
Two-Way Shear (Punching) (lbf)	PASS (69.9%)	16419.4	54600.0	1.2D+1.6L+0.5Lr
One-Way Shear X (lbf)	PASS (81.0%)	4446.9	23400.0	1.2D+1.6L+0.5Lr
Moment X (lbf-ft)	PASS (71.3%)	5419.7	18911.8	1.2D+1.6L+0.5Lr
One-Way Shear Y (lbf)	PASS (78.8%)	4960.0	23400.0	1.2D+1.6L+0.5Lr
Moment Y (lbf-ft)	PASS (66.8%)	6285.5	18911.8	1.2D+1.6L+0.5Lr
Crushing (psi)	PASS (78.0%)	304.1	1381.3	1.2D+1.6L+0.5Lr

LOAD LIST

Type	Name	Left Magnitude	Right Magnitude	Load Start (ft)	Load End (ft)	Load Type	Direction
Point (lbf)	OT	5690	-	0	-	Live	Z

LINKED LOAD LIST

Type	Left Magnitude	Right Magnitude	Load Start (ft)	Load End (ft)	Load Type	Direction
Axial (lbf)	119.2237	119.2237	0	0	Dead	Z
Axial (lbf)	1990.236	1990.236	0	0	Dead	Z
Axial (lbf)	2990	2990	0	0	Live	Z

PASS

DATE:	3/24/2023	COMPANY:	Architects Northwest
STRUCALC BUILD:	StruCalc Plus	DESIGNED BY:	Sarah Weight
CUSTOMER:	Phan-Nguyen	REVIEWED BY:	Sarah Weight
PROJ. ADDRESS:	-- Mercer Island, WA	PROJECT NAME:	Phan-Nguyen
LEVEL:	StruCalc Members	LOADING:	
MEMBER NAME:	F05 - FTG at GT8a (C03)	CODE:	2018 International Building Code
MEMBER TYPE:	ISOLATED FOOTING	ACI:	ACI 318-14
MATERIAL:	Concrete		
3 (ft) X 3 (ft) X 10 (in)		Soil Depth TOF: 0 (ft)	(4) #4 Long, (4) #4 Short

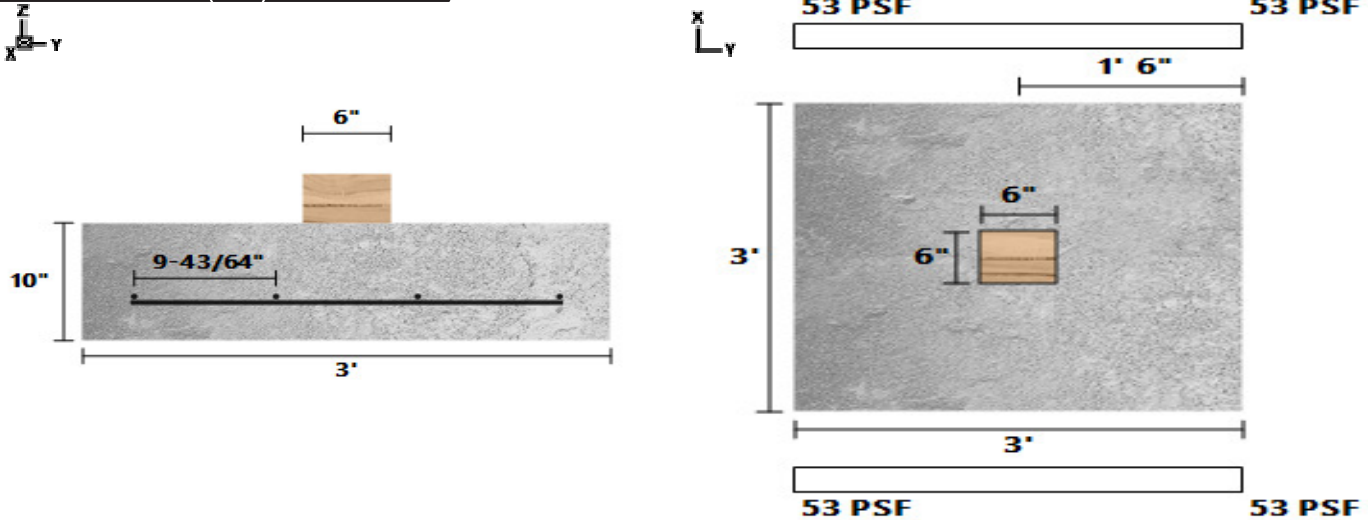
F05 - FTG at GT8a (C03) DIAGRAMS**MATERIAL PROPERTIES**

FOOTING						
fc' (psi)	Ec (psi)	Density (lbf/ft ³)	Width (ft)	Length (ft)	Depth (in)	Volume (ft ³)
2500	2880952	145	3	3	10	7.5
CALCULATION VARIABLES						
Bo (in)	Φ-X	Φ-Y				
50	0	0				
COLUMN						
Width (in)	Length (in)	Material	Offset (in)			
6	6	Wood	0			
SOIL						
Bearing Strength (lbf/ft ²)	Density (lbf/ft ³)	Cohesion	Friction Angle	Depth (ft)	Rankine Coefficient (Kp)	
1500	120	0	30	0	3	
REBAR						
Bar Size #	# Bars Long	# Bars Short	fy (psi)	Es (psi)		
4	4	4	40000	2.9E+07		

PASS-FAIL

	PASS/FAIL	MAGNITUDE	STRENGTH	LOAD COMBO
Soil Bearing Pressure (lbf/ft ²)	PASS (96.5%)	52.9	1500.0	D+Lr
Two-Way Shear (Punching) (lbf)	PASS (98.6%)	676.6	48750.0	1.2D+1.6Lr+L
One-Way Shear X (lbf)	PASS (99.1%)	159.7	17550.0	1.2D+1.6Lr+L
Moment X (lbf-ft)	PASS (98.8%)	176.2	15098.0	1.2D+1.6Lr+L
One-Way Shear Y (lbf)	PASS (99.1%)	159.7	17550.0	1.2D+1.6Lr+L
Moment Y (lbf-ft)	PASS (98.8%)	176.2	15098.0	1.2D+1.6Lr+L
Crushing (psi)	PASS (98.6%)	18.8	1381.3	1.2D+1.6Lr+L

LOAD LIST

Type	Name	Left Magnitude	Right Magnitude	Load Start (ft)	Load End (ft)	Load Type	Direction
------	------	----------------	-----------------	-----------------	---------------	-----------	-----------

LINKED LOAD LIST

Type	Left Magnitude	Right Magnitude	Load Start (ft)	Load End (ft)	Load Type	Direction
Axial (lbf)	212.8614	212.8614	0	0	Dead	Z
Axial (lbf)	263.2002	263.2002	0	0	RoofLive	Z

PASS

DATE:	3/24/2023	COMPANY:	Architects Northwest
STRUCALC BUILD:	StruCalc Plus	DESIGNED BY:	Sarah Weight
CUSTOMER:	Phan-Nguyen	REVIEWED BY:	Sarah Weight
PROJ. ADDRESS:	-- Mercer Island, WA	PROJECT NAME:	Phan-Nguyen
LEVEL:	StruCalc Members	LOADING:	
MEMBER NAME:	F06 - FTG at M03a (C31)	CODE:	2018 International Building Code
MEMBER TYPE:	ISOLATED FOOTING	ACI:	ACI 318-14
MATERIAL:	Concrete		
2.5 (ft) X 2.5 (ft) X 10 (in)		Soil Depth TOF: 0 (ft)	(3) #4 Long, (4) #4 Short

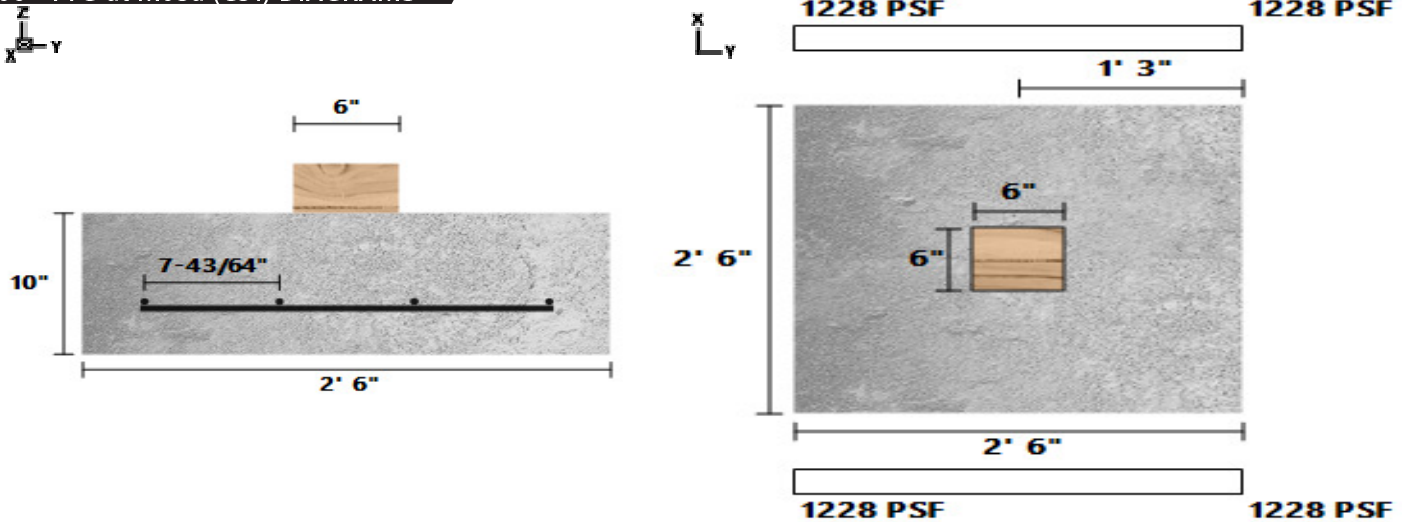
F06 - FTG at M03a (C31) DIAGRAMS**MATERIAL PROPERTIES**

FOOTING						
fc' (psi)	Ec (psi)	Density (lbf/ft ³)	Width (ft)	Length (ft)	Depth (in)	Volume (ft ³)
2500	2880952	145	2.5	2.5	10	5.21
CALCULATION VARIABLES						
Bo (in)	Φ-X	Φ-Y				
50	0	0				
COLUMN						
Width (in)	Length (in)	Material	Offset (in)			
6	6	Wood	0			
SOIL						
Bearing Strength (lbf/ft ²)	Density (lbf/ft ³)	Cohesion	Friction Angle	Depth (ft)	Rankine Coefficient (Kp)	
1500	120	0	30	0	3	
REBAR						
Bar Size #	# Bars Long	# Bars Short	fy (psi)	Es (psi)		
4	4	3	40000	2.9E+07		

PASS-FAIL

	PASS/FAIL	MAGNITUDE	STRENGTH	LOAD COMBO
Soil Bearing Pressure (lbf/ft ²)	PASS (18.1%)	1228.3	1500.0	D+L
Two-Way Shear (Punching) (lbf)	PASS (77.2%)	11128.1	48750.0	1.2D+1.6L+0.5Lr
One-Way Shear X (lbf)	PASS (86.1%)	2040.2	14625.0	1.2D+1.6L+0.5Lr
Moment X (lbf-ft)	PASS (44.4%)	2225.6	4000.0	1.2D+1.6L+0.5Lr
One-Way Shear Y (lbf)	PASS (86.1%)	2040.2	14625.0	1.2D+1.6L+0.5Lr
Moment Y (lbf-ft)	PASS (44.4%)	2225.6	4000.0	1.2D+1.6L+0.5Lr
Crushing (psi)	PASS (77.6%)	309.1	1381.3	1.2D+1.6L+0.5Lr

LOAD LIST

Type	Name	Left Magnitude	Right Magnitude	Load Start (ft)	Load End (ft)	Load Type	Direction
------	------	----------------	-----------------	-----------------	---------------	-----------	-----------

LINKED LOAD LIST

Type	Left Magnitude	Right Magnitude	Load Start (ft)	Load End (ft)	Load Type	Direction
Axial (lbf)	2887.162	2887.162	0	0	Dead	Z
Axial (lbf)	4789.708	4789.708	0	0	Live	Z

PASS

DATE:	3/24/2023	COMPANY:	Architects Northwest
STRUCALC BUILD:	StruCalc Plus	DESIGNED BY:	Sarah Weight
CUSTOMER:	Phan-Nguyen	REVIEWED BY:	Sarah Weight
PROJ. ADDRESS:	-- Mercer Island, WA	PROJECT NAME:	Phan-Nguyen
LEVEL:	StruCalc Members	LOADING:	
MEMBER NAME:	F07 - FTG at U03a & M03b (C32)	CODE:	2018 International Building Code
MEMBER TYPE:	ISOLATED FOOTING	ACI:	ACI 318-14
MATERIAL:	Concrete		
3 (ft) X 3 (ft) X 10 (in)		Soil Depth TOF: 0 (ft)	(4) #4 Long, (4) #4 Short

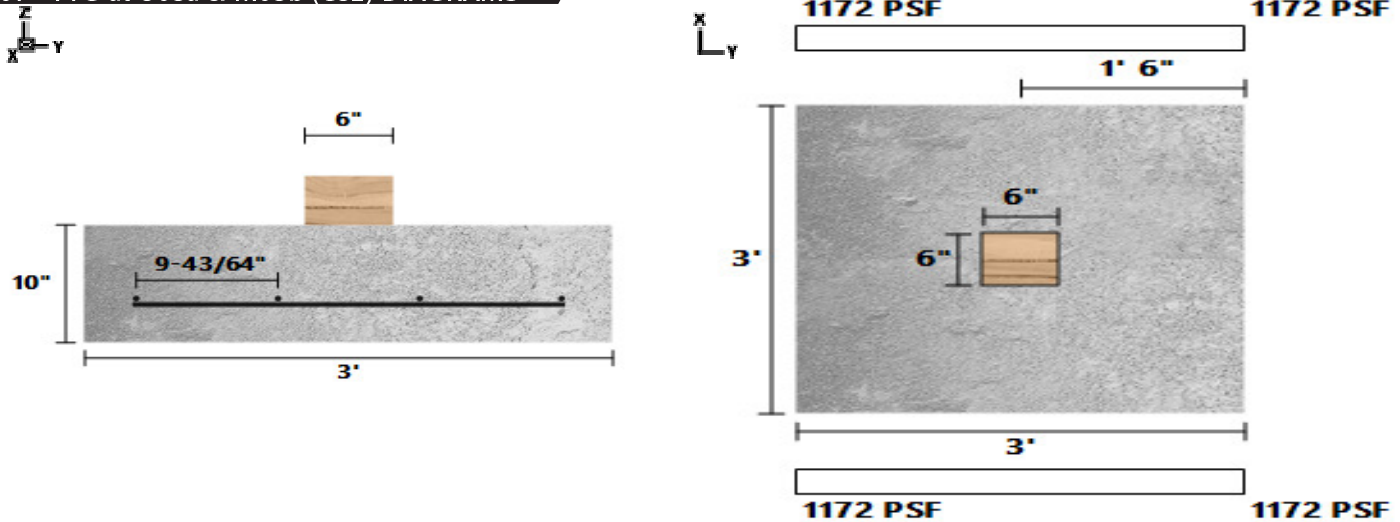
F07 - FTG at U03a & M03b (C32) DIAGRAMS**MATERIAL PROPERTIES**

FOOTING						
fc' (psi)	Ec (psi)	Density (lbf/ft ³)	Width (ft)	Length (ft)	Depth (in)	Volume (ft ³)
2500	2880952	145	3	3	10	7.5
CALCULATION VARIABLES						
Bo (in)	Φ-X	Φ-Y				
50	0	0				
COLUMN						
Width (in)	Length (in)	Material	Offset (in)			
6	6	Wood	0			
SOIL						
Bearing Strength (lbf/ft ²)	Density (lbf/ft ³)	Cohesion	Friction Angle	Depth (ft)	Rankine Coefficient (Kp)	
1500	120	0	30	0	3	
REBAR						
Bar Size #	# Bars Long	# Bars Short	fy (psi)	Es (psi)		
4	4	4	40000	2.9E+07		

PASS-FAIL

	PASS/FAIL	MAGNITUDE	STRENGTH	LOAD COMBO
Soil Bearing Pressure (lbf/ft ²)	PASS (21.9%)	1171.7	1500.0	D+L
Two-Way Shear (Punching) (lbf)	PASS (69.1%)	15058.0	48750.0	1.2D+1.6L+0.5Lr
One-Way Shear X (lbf)	PASS (79.7%)	3555.3	17550.0	1.2D+1.6L+0.5Lr
Moment X (lbf-ft)	PASS (74.0%)	3921.3	15098.0	1.2D+1.6L+0.5Lr
One-Way Shear Y (lbf)	PASS (79.7%)	3555.3	17550.0	1.2D+1.6L+0.5Lr
Moment Y (lbf-ft)	PASS (74.0%)	3921.3	15098.0	1.2D+1.6L+0.5Lr
Crushing (psi)	PASS (69.7%)	418.3	1381.3	1.2D+1.6L+0.5Lr

LOAD LIST

Type	Name	Left Magnitude	Right Magnitude	Load Start (ft)	Load End (ft)	Load Type	Direction
------	------	----------------	-----------------	-----------------	---------------	-----------	-----------

LINKED LOAD LIST

Type	Left Magnitude	Right Magnitude	Load Start (ft)	Load End (ft)	Load Type	Direction
Axial (lbf)	1264.656	1264.656	0	0	Dead	Z
Axial (lbf)	955.9999	955.9999	0	0	Live	Z
Axial (lbf)	3269.913	3269.913	0	0	Dead	Z
Axial (lbf)	5054.292	5054.292	0	0	Live	Z

DATE:	3/24/2023	COMPANY:	Architects Northwest
STRUCALC BUILD:	StruCalc Plus	DESIGNED BY:	Sarah Weight
CUSTOMER:	Phan-Nguyen	REVIEWED BY:	Sarah Weight
PROJ. ADDRESS:	-- Mercer Island, WA	PROJECT NAME:	Phan-Nguyen
LEVEL:	StruCalc Members	LOADING:	
MEMBER NAME:	F08 - FTG at M06a (C35)	CODE:	2018 International Building Code
MEMBER TYPE:	ISOLATED FOOTING	ACI:	ACI 318-14
MATERIAL:	Concrete		
2 (ft) X 2 (ft) X 10 (in)		Soil Depth TOF: 0 (ft)	(3) #4 Long, (3) #4 Short

F08 - FTG at M06a (C35) DIAGRAMS

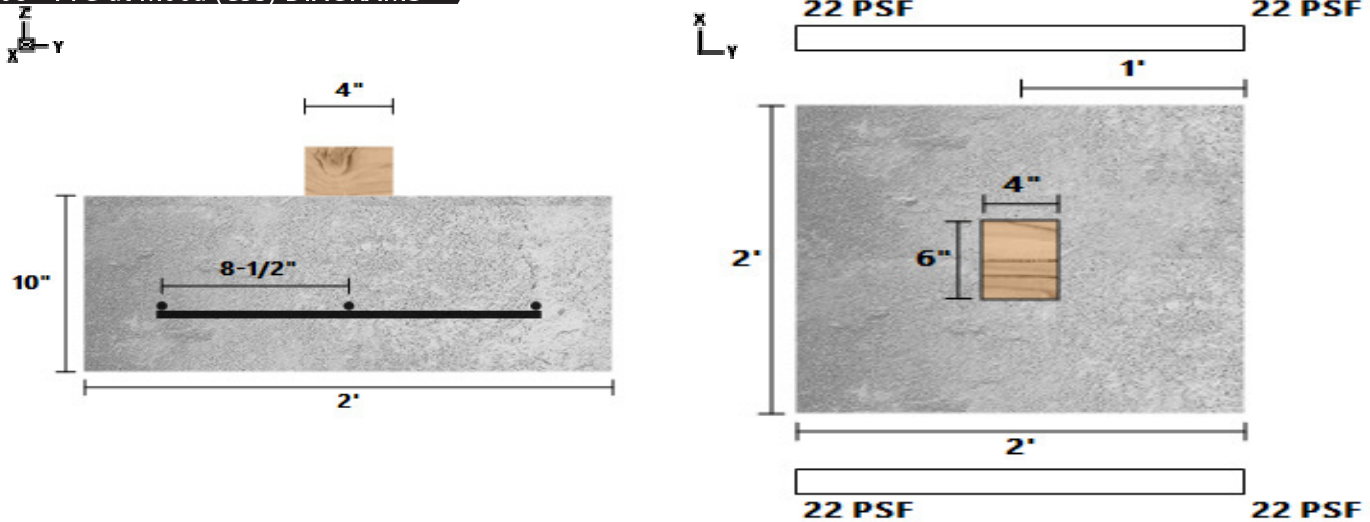

MATERIAL PROPERTIES

FOOTING						
fc' (psi)	Ec (psi)	Density (lbf/ft ³)	Width (ft)	Length (ft)	Depth (in)	Volume (ft ³)
2500	2880952	145	2	2	10	3.33
CALCULATION VARIABLES						
Bo (in)	Φ-X	Φ-Y				
46	0	0				
COLUMN						
Width (in)	Length (in)	Material	Offset (in)			
4	6	Wood	0			
SOIL						
Bearing Strength (lbf/ft ²)	Density (lbf/ft ³)	Cohesion	Friction Angle	Depth (ft)	Rankine Coefficient (Kp)	
1500	120	0	30	0	3	
REBAR						
Bar Size #	# Bars Long	# Bars Short	fy (psi)	Es (psi)		
4	3	3	40000	2.9E+07		

PASS-FAIL

	PASS/FAIL	MAGNITUDE	STRENGTH	LOAD COMBO
Soil Bearing Pressure (lbf/ft ²)	PASS (98.6%)	21.6	1500.0	D
Two-Way Shear (Punching) (lbf)	PASS (99.7%)	121.0	44850.0	1.4D
One-Way Shear X (lbf)	PASS (99.9%)	12.6	11700.0	1.4D
Moment X (lbf-ft)	PASS (99.5%)	17.0	3200.0	1.4D
One-Way Shear Y (lbf)	PASS (99.8%)	17.6	11700.0	1.4D
Moment Y (lbf-ft)	PASS (99.3%)	21.0	3200.0	1.4D
Crushing (psi)	PASS (99.6%)	5.0	1381.3	1.4D

LOAD LIST

Type	Name	Left Magnitude	Right Magnitude	Load Start (ft)	Load End (ft)	Load Type	Direction
------	------	----------------	-----------------	-----------------	---------------	-----------	-----------

LINKED LOAD LIST

Type	Left Magnitude	Right Magnitude	Load Start (ft)	Load End (ft)	Load Type	Direction
Axial (lbf)	86.43503	86.43503	0	0	Dead	Z

PASS

DATE:	3/24/2023	COMPANY:	Architects Northwest
STRUCALC BUILD:	StruCalc Plus	DESIGNED BY:	Sarah Weight
CUSTOMER:	Phan-Nguyen	REVIEWED BY:	Sarah Weight
PROJ. ADDRESS:	-- Mercer Island, WA	PROJECT NAME:	Phan-Nguyen
LEVEL:	StruCalc Members	LOADING:	
MEMBER NAME:	F09 - FTG at R03b, HDR, U10b, & U0...	CODE:	2018 International Building Code
MEMBER TYPE:	ISOLATED FOOTING	ACI:	ACI 318-14
MATERIAL:	Concrete		
3 (ft) X 3 (ft) X 10 (in)		Soil Depth TOF: 0 (ft)	(4) #4 Long, (4) #4 Short

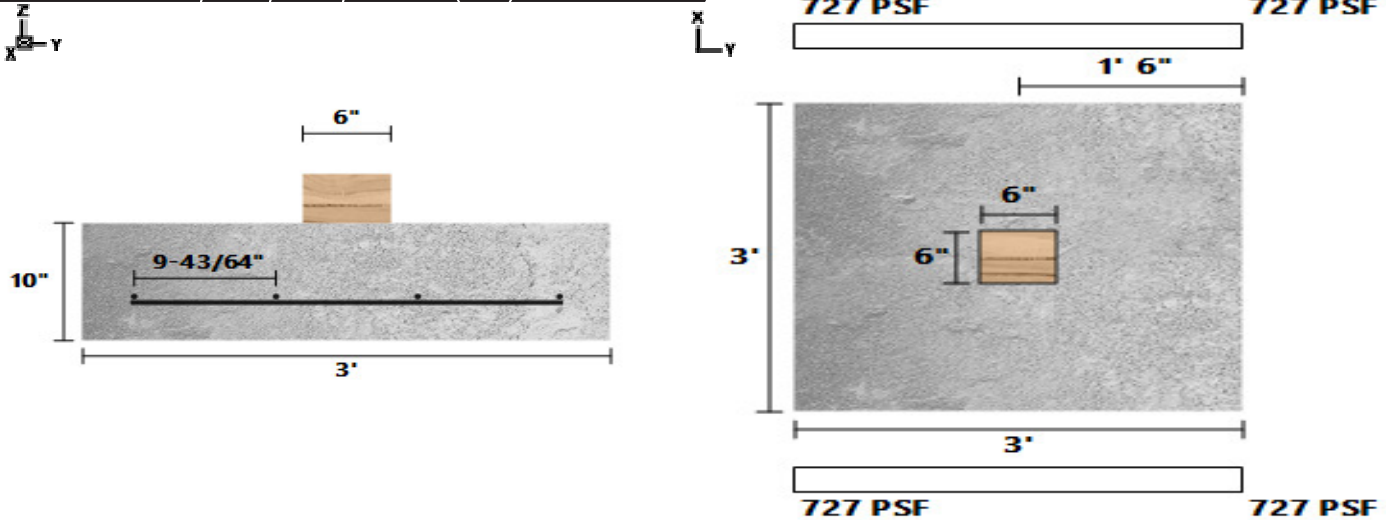
F09 - FTG at R03b, HDR, U10b, & U09b (C22) DIAGRAMS**MATERIAL PROPERTIES**

FOOTING						
fc' (psi)	Ec (psi)	Density (lbf/ft ³)	Width (ft)	Length (ft)	Depth (in)	Volume (ft ³)
2500	2880952	145	3	3	10	7.5
CALCULATION VARIABLES						
Bo (in)	Φ-X	Φ-Y				
50	0	0				
COLUMN						
Width (in)	Length (in)	Material	Offset (in)			
6	6	Wood	0			
SOIL						
Bearing Strength (lbf/ft ²)	Density (lbf/ft ³)	Cohesion	Friction Angle	Depth (ft)	Rankine Coefficient (Kp)	
1500	120	0	30	0	3	
REBAR						
Bar Size #	# Bars Long	# Bars Short	fy (psi)	Es (psi)		
4	4	4	40000	2.9E+07		

PASS-FAIL

	PASS/FAIL	MAGNITUDE	STRENGTH	LOAD COMBO
Soil Bearing Pressure (lbf/ft ²)	PASS (51.6%)	726.7	1500.0	D+0.75L+0.75Lr
Two-Way Shear (Punching) (lbf)	PASS (81.0%)	9286.3	48750.0	1.2D+1.6L+0.5Lr
One-Way Shear X (lbf)	PASS (87.5%)	2192.6	17550.0	1.2D+1.6L+0.5Lr
Moment X (lbf-ft)	PASS (84.0%)	2418.3	15098.0	1.2D+1.6L+0.5Lr
One-Way Shear Y (lbf)	PASS (87.5%)	2192.6	17550.0	1.2D+1.6L+0.5Lr
Moment Y (lbf-ft)	PASS (84.0%)	2418.3	15098.0	1.2D+1.6L+0.5Lr
Crushing (psi)	PASS (81.3%)	258.0	1381.3	1.2D+1.6L+0.5Lr

LOAD LIST

Type	Name	Left Magnitude	Right Magnitude	Load Start (ft)	Load End (ft)	Load Type	Direction
Point (lbf)	HDR	469	-	0	-	Live	Z
Point (lbf)	HDR	327	-	0	-	Dead	Z

LINKED LOAD LIST

Type	Left Magnitude	Right Magnitude	Load Start (ft)	Load End (ft)	Load Type	Direction
Axial (lbf)	126.2368	126.2368	0	0	Dead	Z
Axial (lbf)	2169.296	2169.296	0	0	Dead	Z
Axial (lbf)	1044	1044	0	0	Live	Z
Axial (lbf)	1350	1350	0	0	RoofLive	Z
Axial (lbf)	786.892	786.892	0	0	Dead	Z
Axial (lbf)	1311.962	1311.962	0	0	Live	Z

PASS

DATE:	3/24/2023	COMPANY:	Architects Northwest
STRUCALC BUILD:	StruCalc Plus	DESIGNED BY:	Sarah Weight
CUSTOMER:	Phan-Nguyen	REVIEWED BY:	Sarah Weight
PROJ. ADDRESS:	-- Mercer Island, WA	PROJECT NAME:	Phan-Nguyen
LEVEL:	StruCalc Members	LOADING:	
MEMBER NAME:	F10 - FTG at R03a, HDR, U11b, & U09...	CODE:	2018 International Building Code
MEMBER TYPE:	ISOLATED FOOTING	ACI:	ACI 318-14
MATERIAL:	Concrete		
3 (ft) X 3 (ft) X 10 (in)		Soil Depth TOF: 0 (ft)	(4) #4 Long, (4) #4 Short

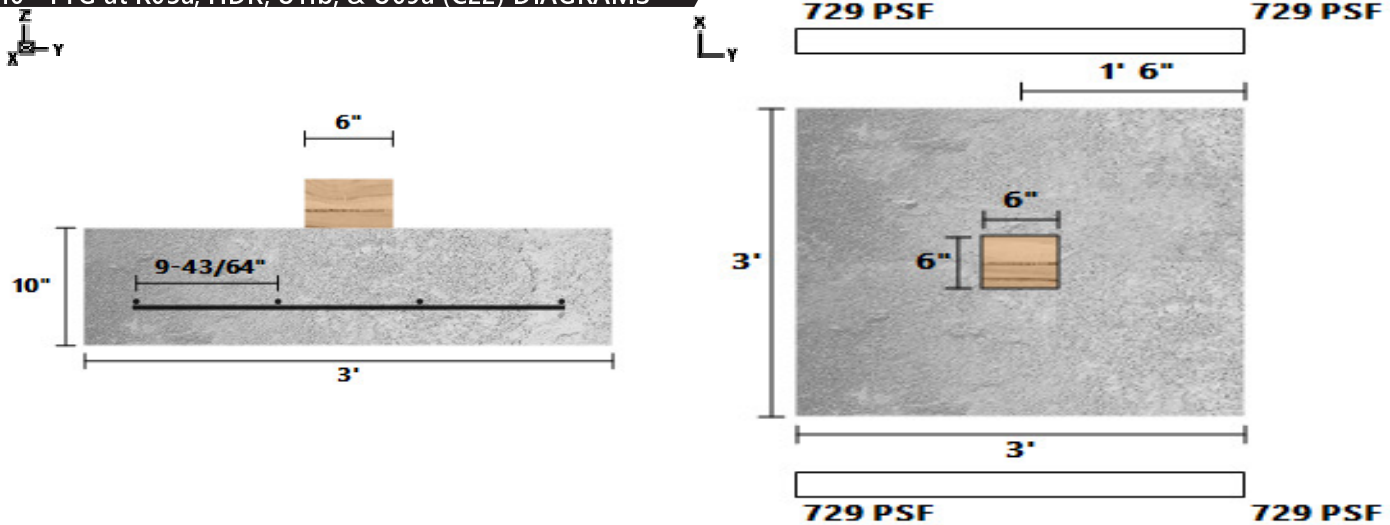
F10 - FTG at R03a, HDR, U11b, & U09a (C22) DIAGRAMS**MATERIAL PROPERTIES**

FOOTING						
fc' (psi)	Ec (psi)	Density (lbf/ft ³)	Width (ft)	Length (ft)	Depth (in)	Volume (ft ³)
2500	2880952	145	3	3	10	7.5
CALCULATION VARIABLES						
Bo (in)	Φ-X	Φ-Y				
50	0	0				
COLUMN						
Width (in)	Length (in)	Material	Offset (in)			
6	6	Wood	0			
SOIL						
Bearing Strength (lbf/ft ²)	Density (lbf/ft ³)	Cohesion	Friction Angle	Depth (ft)	Rankine Coefficient (Kp)	
1500	120	0	30	0	3	
REBAR						
Bar Size #	# Bars Long	# Bars Short	fy (psi)	Es (psi)		
4	4	4	40000	2.9E+07		

PASS-FAIL

	PASS/FAIL	MAGNITUDE	STRENGTH	LOAD COMBO
Soil Bearing Pressure (lbf/ft ²)	PASS (51.4%)	729.0	1500.0	D+0.75L+0.75Lr
Two-Way Shear (Punching) (lbf)	PASS (80.9%)	9329.4	48750.0	1.2D+1.6L+0.5Lr
One-Way Shear X (lbf)	PASS (87.4%)	2202.8	17550.0	1.2D+1.6L+0.5Lr
Moment X (lbf-ft)	PASS (83.9%)	2429.5	15098.0	1.2D+1.6L+0.5Lr
One-Way Shear Y (lbf)	PASS (87.4%)	2202.8	17550.0	1.2D+1.6L+0.5Lr
Moment Y (lbf-ft)	PASS (83.9%)	2429.5	15098.0	1.2D+1.6L+0.5Lr
Crushing (psi)	PASS (81.2%)	259.2	1381.3	1.2D+1.6L+0.5Lr

LOAD LIST

Type	Name	Left Magnitude	Right Magnitude	Load Start (ft)	Load End (ft)	Load Type	Direction
Point (lbf)	HDR	496	-	0	-	Live	Z
Point (lbf)	HDR	327	-	0	-	Dead	Z

LINKED LOAD LIST

Type	Left Magnitude	Right Magnitude	Load Start (ft)	Load End (ft)	Load Type	Direction
Axial (lbf)	126.2368	126.2368	0	0	Dead	Z
Axial (lbf)	2169.296	2169.296	0	0	Dead	Z
Axial (lbf)	1044	1044	0	0	Live	Z
Axial (lbf)	1350	1350	0	0	RoofLive	Z
Axial (lbf)	786.892	786.892	0	0	Dead	Z
Axial (lbf)	1311.962	1311.962	0	0	Live	Z

PASS

DATE:	3/24/2023	COMPANY:	Architects Northwest
STRUCALC BUILD:	StruCalc Plus	DESIGNED BY:	Sarah Weight
CUSTOMER:	Phan-Nguyen	REVIEWED BY:	Sarah Weight
PROJ. ADDRESS:	-- Mercer Island, WA	PROJECT NAME:	Phan-Nguyen
LEVEL:	StruCalc Members	LOADING:	
MEMBER NAME:	F11 - FTG at U14a (C27)	CODE:	2018 International Building Code
MEMBER TYPE:	ISOLATED FOOTING	ACI:	ACI 318-14
MATERIAL:	Concrete		
3 (ft) X 3 (ft) X 10 (in)		Soil Depth TOF: 0 (ft)	(4) #4 Long, (4) #4 Short

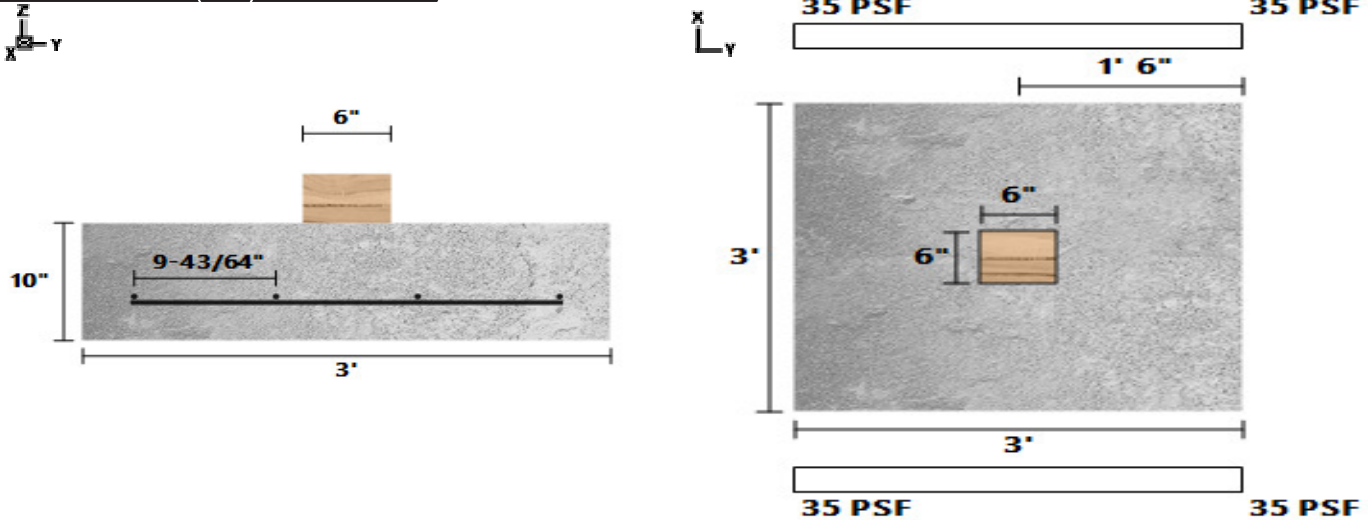
F11 - FTG at U14a (C27) DIAGRAMS**MATERIAL PROPERTIES**

FOOTING						
fc' (psi)	Ec (psi)	Density (lbf/ft ³)	Width (ft)	Length (ft)	Depth (in)	Volume (ft ³)
2500	2880952	145	3	3	10	7.5
CALCULATION VARIABLES						
Bo (in)	Φ-X	Φ-Y				
50	0	0				
COLUMN						
Width (in)	Length (in)	Material	Offset (in)			
6	6	Wood	0			
SOIL						
Bearing Strength (lbf/ft ²)	Density (lbf/ft ³)	Cohesion	Friction Angle	Depth (ft)	Rankine Coefficient (Kp)	
1500	120	0	30	0	3	
REBAR						
Bar Size #	# Bars Long	# Bars Short	fy (psi)	Es (psi)		
4	4	4	40000	2.9E+07		

PASS-FAIL

	PASS/FAIL	MAGNITUDE	STRENGTH	LOAD COMBO
Soil Bearing Pressure (lbf/ft ²)	PASS (97.7%)	34.5	1500.0	D+Lr
Two-Way Shear (Punching) (lbf)	PASS (99.2%)	408.9	48750.0	1.2D+1.6Lr+L
One-Way Shear X (lbf)	PASS (99.4%)	96.5	17550.0	1.2D+1.6Lr+L
Moment X (lbf-ft)	PASS (99.3%)	106.5	15098.0	1.2D+1.6Lr+L
One-Way Shear Y (lbf)	PASS (99.4%)	96.5	17550.0	1.2D+1.6Lr+L
Moment Y (lbf-ft)	PASS (99.3%)	106.5	15098.0	1.2D+1.6Lr+L
Crushing (psi)	PASS (99.2%)	11.4	1381.3	1.2D+1.6Lr+L

LOAD LIST

Type	Name	Left Magnitude	Right Magnitude	Load Start (ft)	Load End (ft)	Load Type	Direction
------	------	----------------	-----------------	-----------------	---------------	-----------	-----------

LINKED LOAD LIST

Type	Left Magnitude	Right Magnitude	Load Start (ft)	Load End (ft)	Load Type	Direction
Axial (lbf)	220.5222	220.5222	0	0	Dead	Z
Axial (lbf)	90.17822	90.17822	0	0	RoofLive	Z

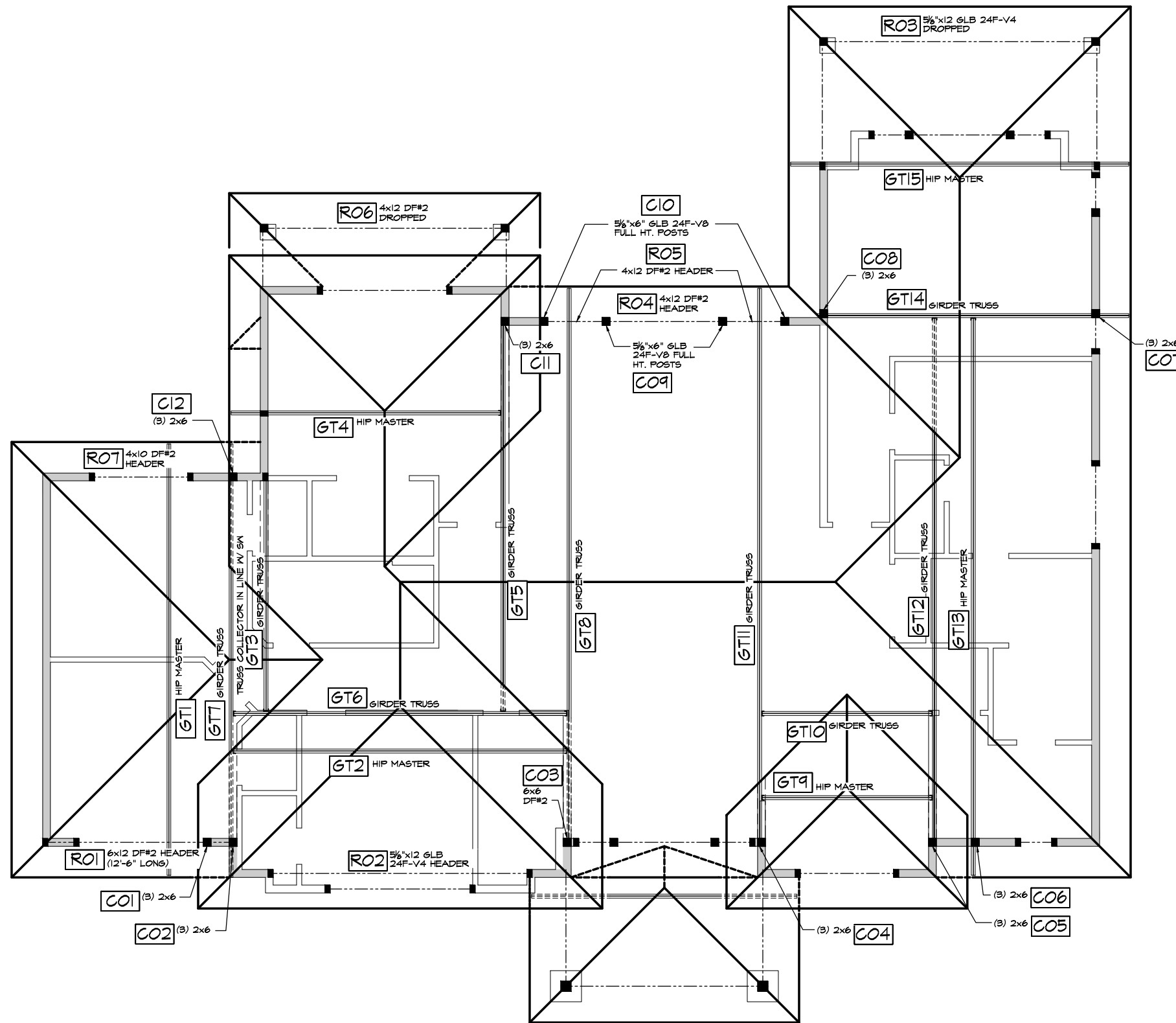

BEAM KEY

SCALE: 1/8" = 1'-0"

ROOF FRAMING

18915-142nd AVENUE NE SUITE 100
 WOODINVILLE, WA 98072
 TOLL FREE: 1-888-884-9488
 FAX: (425) 487-6585

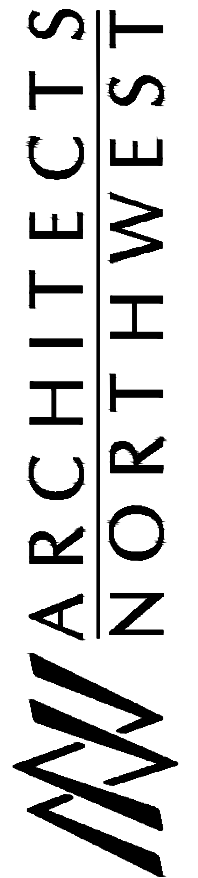

DESIGNED BY: SW DATE: 12/2022
 DRAWN BY: JSC DATE: 3/21/23

PROJECT MANAGER: SARAH WEIGHT
 REVISED BY: DATE:

ANW WOODINVILLE OFFICE
 JOB NUMBER: 220185

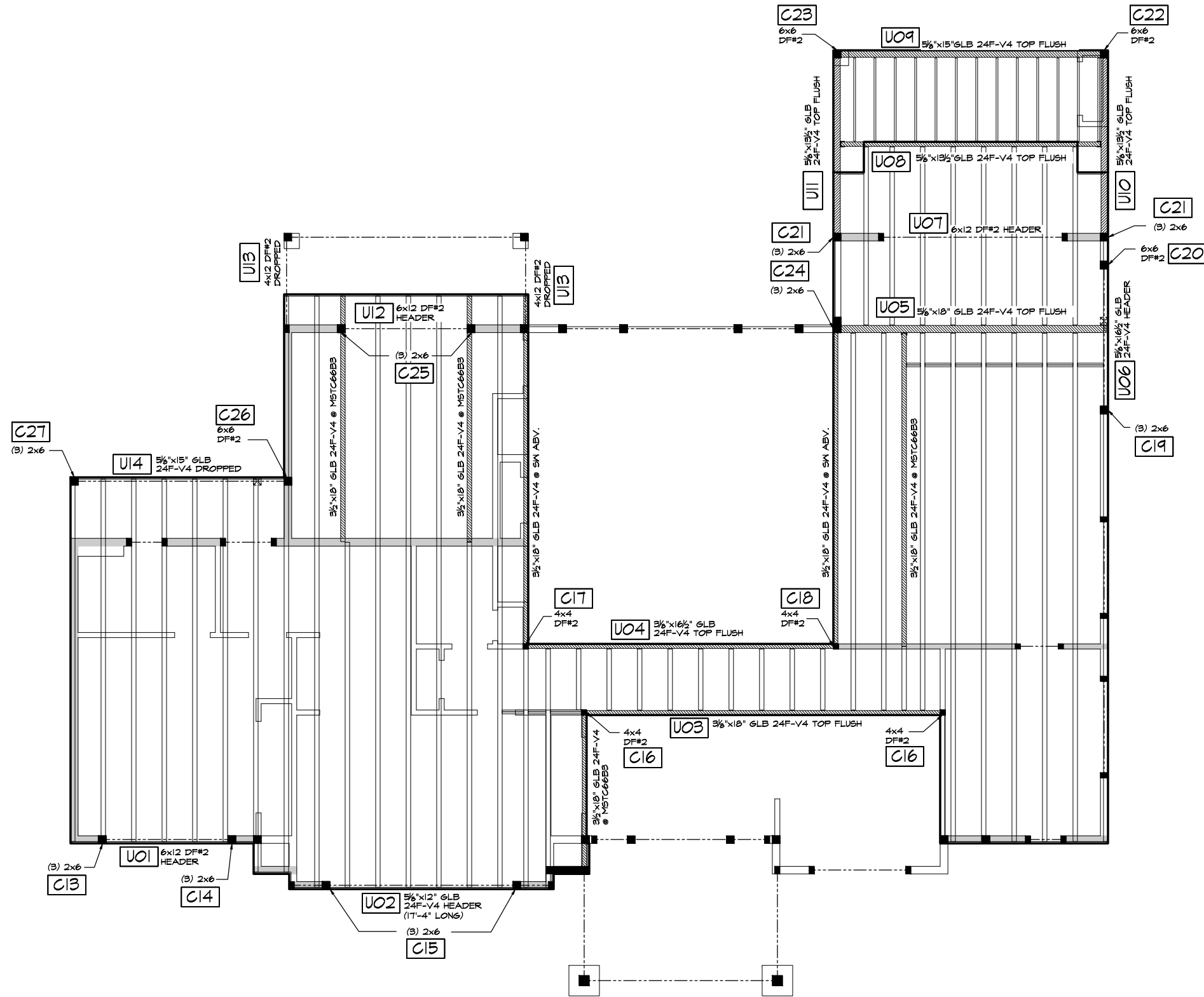

BEAM KEY

SCALE: 1/8" = 1'-0"

UPPER FLOOR FRAMING

18915-142nd AVENUE NE SUITE 100
 WOODINVILLE, WA 98072
 TOLL FREE: 1-888-884-9488
 FAX: (425) 487-6585

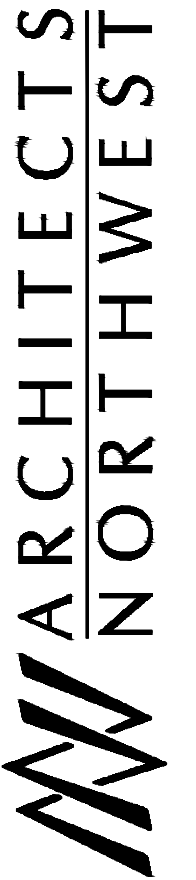

DESIGNED BY: SW DATE: 12/2022
 DRAWN BY: JSC DATE: 3/21/23

PROJECT MANAGER:
 SARAH WEIGHT
 REVISED BY: DATE:

ANW WOODINVILLE OFFICE
 JOB NUMBER:
 220185

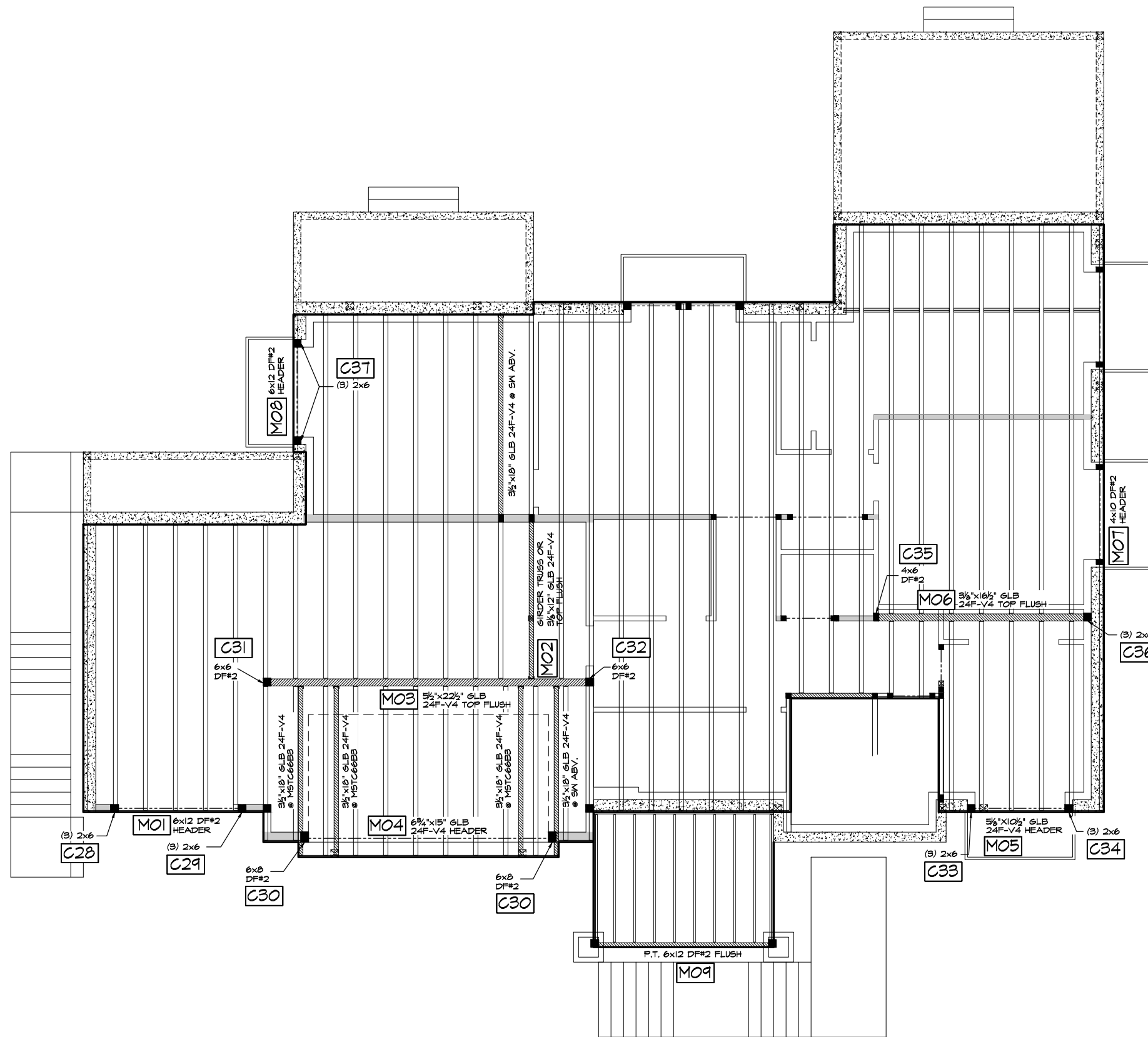

BEAM KEY

SCALE: 1/8" = 1'-0"

MAIN FLOOR FRAMING

ANW ARCHITECTS NORTHWEST

18915-142nd AVENUE NE SUITE 100
WOODINVILLE, WA 98072
TOLL FREE: 1-888-884-9488
FAX: (425) 487-6585

DESIGNED BY: SW DATE: 12/2022
DRAWN BY: JSC DATE: 3/21/23

PROJECT MANAGER: SARAH WEIGHT
REVISED BY: DATE:

ANW WOODINVILLE OFFICE
JOB NUMBER:
220185

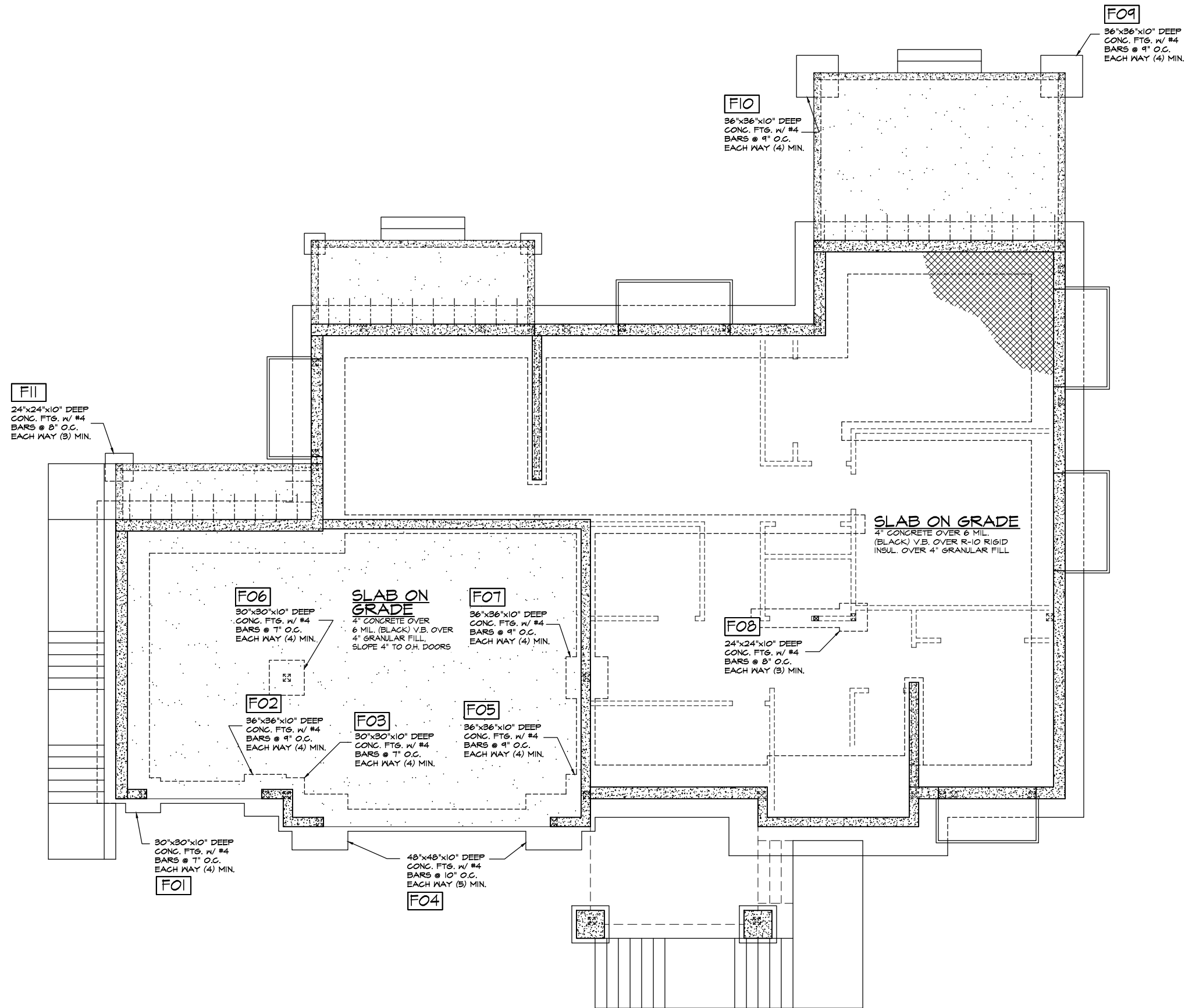

BEAM KEY

SCALE: 1/8" = 1'-0"

FND/FOOTINGS

18915-142nd AVENUE NE SUITE 100
WOODINVILLE, WA 98072
TOLL FREE: 1-888-884-9488
FAX: (425) 487-6585

ANW ARCHITECTS NORTHWEST

DESIGNED BY: DATE:
SW 12/2022
DRAWN BY: DATE:
JSC 3/21/23

PROJECT MANAGER:
SARAH WEIGHT
REVISED BY: DATE:

ANW WOODINVILLE OFFICE
JOB NUMBER:
220185